

Operator's Manual



Computed Tomography Imaging X-ray System



2800 Bronze Drive, Suite 110
Hatfield, PA 19440
Technical Support: 267-483-8081
info@curvebeamai.com
www.curvebeamai.com

Table of Contents

CHAPTER 1: Introduction	5
Warnings, Cautions, Advice, and Notes	5
Safety Precautions	6
Electrical Hazards	7
Explosion Hazard	8
Mechanical Hazards	9
Laser Beam Hazards	9
System Safety Devices	9
Cabling Requirements	9
Radiation Safety	10
System Description	11
Major Device Components	12
Intended Use of the Device	14
Major System Items	14
Intended User Profile	14
Contraindications	14
About the Operators' Manual	15
Conventions Used in the User Manual	15
Warranty	15
CHAPTER 2: Product Information	16
Technical Specifications	16
Network Diagram	19
Power Requirements	20
Apparent Resistance of Supply Mains	21
Environmental Specifications	21
Electromagnetic or other Interference (Emissions and Immunity)	24
Equipment Standards	27
Equipment Class	27
Regulatory Class	27
Cleaning	28
Patient Preparation Recommendations	28

Preventive Maintenance Schedule - for Owner / User	29
Planned Maintenance – Monthly Schedule	29
Planned Maintenance - Annual Schedule.....	30
UPS (Uninterruptible Power Supply) Maintenance.....	30
Cyber Security Recommendations.....	30
Replacement Parts.....	31
Accessories.....	31
System Dimensions.....	32
CHAPTER 3: Safety Items.....	34
System Safety Devices	34
Emergency Removal of a Patient.....	36
Recommended Coverings.....	37
System Labels.....	38
System Controls and Indicators	51
CHAPTER 4: Calibration and Quality Assurance (QA) Procedures	53
Calibration Procedures.....	53
Quality Assurance Procedures.....	54
Radiation Output Test	63
CHAPTER 5: Radiation Environment Survey	64
Scatter Measurements	64
CTDI Measurements	66
Dose Profile.....	68
Modulation Transfer Function (MTF).....	70
Uniformity	72
CT Number Accuracy.....	73
Exposure-mAs Linearity	75
Timer Accuracy	76
Half Value Layer Results.....	77
Z-axis point spread function	78
Recommended Operating Requirements.....	78
Site Survey	79
X-ray Tube Assembly	80
Beam Path and Angulation.....	82

Geometric Efficiency	84
CHAPTER 6: Operations - Acquiring a Scan.....	85
System Startup.....	85
PATIENT Tab: Accessing/Entering Patient Information & Selecting Scan Procedure	86
PROTOCOL Tab: Selecting the Protocol	89
RECOMMENDATIONS for Selecting a Protocol	90
SCAN Tab: Performing the Acquisition	91
Turning the System Off	95
Viewing the Images	95
CHAPTER 7: Patient Positioning	96
Weight Bearing Foot/Feet Scan.....	96
Weight Bearing Leg or Hip Scan	97
Non-Weight Bearing Foot/Feet or Knees Scan – Utilizing Patient Chair	97
Upper Extremity Scan	97
Positioning the Foot/Feet.....	98
APPENDIX I: Troubleshooting	100
Warning Messages.....	100
HiRise Known Issues:	103
APPENDIX II: Scan Protocol Technical Details	108
APPENDIX III: Pediatric Use Summary	112

HiRise™ User's Manual

CHAPTER 1: Introduction

In order to maintain the safety of patients and operators of this device, it is important to operate and maintain the system correctly, following all instructions, warnings, cautions in this manual and labeling on the system itself. Installation Instructions are detailed in Appendix I.

For technical support or questions contact CurveBeam at 267-483-8081

If any serious incident occurs in relation to the device should be reported to CurveBeam (Contact CurveBeam Technical Support at the number mentioned above) and competent authority of the member states in which the user and/or patient is established.

Warnings, Cautions, Advice, and Notes

Before attempting to operate the equipment, it is recommended that you read this manual thoroughly including all cautions and warnings. This guide uses the following conventions to describe situations that are potential hazards to the Patient or Operator, potential loss of data, or potential damage to the equipment.

WARNING

Warnings are intended to alert the user that failure to follow the procedure could cause fatal or serious injury to the user, Patient, or any other person, or result in a misdiagnosis.

CAUTION

Cautions are intended to alert the user that failure to follow the procedure could cause damage to the equipment or cause loss of data.

NOTE

Notes are used to highlight important or unusual points to be brought to the attention of the operator.

Advice

Refer to user manual.

Safety Precautions

 **WARNING:** The X-ray device is intended to be used for patients 40 lbs (18.1 kg) to 450 lbs (204 kg) and groin area at least 22" (56 cm) above the floor. DO NOT use this device for any patient less than 40 lbs (18.1 kg) OR groin area less than 22" (56 cm) above the floor, whichever is more restrictive.

 **WARNING:** The patient must wear a protective full wrap X-ray shielding apron (lead apron) during a scan unless the Hip or Pelvis are to be imaged. Patients less than 21 years old, small size patients (under 100 pounds) and children must also wear a gonad and ovarian front and back protective shield when appropriate for the anatomy being imaged.

 **WARNING:** The X-ray device may be dangerous to the Patient and Operator if you do not observe and follow operating instructions. Do not operate this system unless you have received training to perform a procedure.

 **WARNING:** Do not remove covers or cables on system. High voltage is present in the system. To avoid personal injury from electrical shock, do not operate the system with any covers open or cables removed. Only CurveBeam authorized personnel are allowed to service the system.

 **WARNING:** This device may cause detrimental interaction with active implantable medical devices and body worn active medical devices. Consult the manufacturer of such devices for more information.

 **WARNING:** Closing of the Door creates a pinch point. Keep hands and feet clear when closing Door.

 **WARNING:** Reclining and un-reclining of the Patient Chair creates a pinch point. Keep hands clear when adjusting the back of the Patient Chair.

 **WARNING:** The Gantry should not be raised or lowered with the Patient Chair engaged for a scan or patient positioning.

 **WARNING:** The back of the Patient Chair shall not be used as a seat.

 **WARNING:** The lower/feet part of the Patient Chair shall not be used as a seat.

 **WARNING:** No modification of this equipment is allowed.

⚠ WARNING: Service and maintenance can only be performed by CurveBeam authorized service personnel. ONLY CurveBeam authorized replacement parts can be used in the equipment. These requirements must be followed in order to avoid a hazard to the equipment, operator and/or patient. CurveBeam will provide circuit diagrams, component part lists, descriptions, calibrations instructions and instructions for use to assist service personnel with parts and repairs.

⚠ WARNING: This device connects to the customer IT-Network in order for the customer to access scan data for diagnostics. Failure of the customer IT-Network may interrupt or delay access to scan data. Updates or changes to the customer's IT-Network could introduce new risks that may require additional analysis. The customer is responsible for identifying, analyzing, evaluating, and controlling these risks associated with any IT-Network change.

⚠ WARNING: Only CurveBeam supplied platforms, Patient Chairs, and accessories can be used when operating the scanner and scanning patients.

⚠ WARNING: The Operator should always watch the patient while raising or lowering the Patient Chair.

⚠ WARNING: The Operator should always watch the patient while reclining the back of the Patient Chair.

⚠ CAUTION: When initiating an exposure, the external Warning Light is activated a few seconds before the X-ray ON alarm (buzzer) and X-ray ON lights are activated.

⚠ CAUTION: Federal law restricts this device to sale by or on the order of a physician (Rx only).

⚠ CAUTION: No auxiliary software should be installed on the system server and thin client terminals.

Electrical Hazards

Installation and system wiring must meet all requirements of local governing authorities. Please check your local authorities and local codes to determine best practices for a safe installation. Do not place any liquid or food on any part of the consoles or other modules of the system. Observe all fire regulations. Fire extinguishers should be provided for both electrical and non-electrical fires. All operators should be fully trained in the use of fire extinguishers and other fire-fighting equipment and in local fire procedures.

 **WARNING:** In the event of an electrical fire, only use extinguishers that are labelled for that purpose. Using water or other liquids on an electrical fire can lead to fatal or other serious personal injury.

 **WARNING:** In the event of an electrical fire, to reduce the risk of electrical shock, try to isolate the equipment from the electric source before attempting to extinguish the fire.

 **WARNING:** To avoid risk of electric shock, this equipment must only be connected to a supply main with protective earth.

 **WARNING:** The patient chair is designed with an ethernet cord used for production and factory programming only. Under no circumstances should anyone other than CurveBeam approved personnel attempt to interface with the ethernet cord for any purposes.

 **WARNING:** The UPS (Uninterruptible Power Supply) included in this system is considered a multiple socket-outlet (MSO). Connecting electrical equipment to the MSO effectively leads to creating a medical device system and the result can be a reduced level of safety.

 **WARNING:** The UPS (Uninterruptible Power Supply) included in this system is considered a multiple socket-outlet (MSO). The MSO shall not be placed on the floor to prevent the ingress of liquids and to prevent mechanical damage. Furthermore, the MSO must be positioned in such a way as to prevent ingress of liquids and to avoid mechanical damage during normal use.

Explosion Hazard

Do not use the System in the presence of explosive gases or vapors, including anesthetic gases. Use of this system in an environment for which it is not designed can lead to fire or explosion.

 **WARNING:** This unit is not suitable for use in a flammable air mixture environment. If hazardous substances are detected while the system is turned on, do not attempt to turn off the system. Evacuate the area and then remove the hazards before turning off the system.

Mechanical Hazards

The system is designed to detect that the patient door is closed before a scan can be initiated. If the patient door is not closed, then the Operator will be prompted to close the patient door and retry or cancel the scan.

 **WARNING:** Do not operate the system with any covers open or removed. Operating the system with open or removed covers could expose mechanical operating systems that could cause serious or fatal personal injury to you or the Patient. Only qualified and authorized service personnel should remove covers from the system.

Laser Beam Hazards

 **WARNING:** Laser beams can cause optical damage. The operator should avoid looking directly into the beams. The operator should instruct the patient to avoid looking directly into the beams. The use of optical instruments such as eyeglasses with large diopters or mirrors increases eye hazard with this product. The laser on this device is a Class 1M laser. The laser apertures are built into the laser assemblies. The laser assemblies are located behind the x-ray source side covers on the gantry. If at any time the operator notices the laser warning label (see Chapter 3, System Labels) cannot be viewed clearly, they should contact the manufacturer for a replacement.

Wavelength 635+-10nm
Beam Divergence: 55~60 degree
Maximum power or energy outlet: 1mW

System Safety Devices

The system safety devices include an Emergency Stop, Warning System, and Interlock System. These are explained fully in Chapter 3 – Safety Items.

Cabling Requirements

System cabling connections must be installed away from walkways and doorways. It is recommended to run cabling along wall perimeters. If there is a chance of mechanical damage due to the cable location, then the use of conduit or other means of protection should be considered.

Radiation Safety

X-rays are dangerous to both the operator and others in the vicinity unless established safe exposure procedures are strictly observed. Use the following safety measures to ensure safety to the Patient and Operator. The useful and scattered beams can produce serious or fatal bodily injuries to patients and persons in the surrounding area if used by an unskilled operator. Adequate precautions must always be taken to avoid or reduce exposure to the useful beam or to scattered radiation. Operators are strongly urged to comply with the current recommendations of the International Commission on Radiological Protection and, in the United States, the US National Council for Radiological Protection.

Use of Controls or adjustments or performance of procedures other than those specified herein may result in hazardous radiation exposure.

Use the following measures to protect yourself and the patient from unintended exposure to radiation. Anyone who is near the patient during test procedures must observe the following precautions:

- Maintain distance from exposed radiation source in accordance with the facility survey or site plan and shielding designs, provided by a medical physicist. The plan/survey will be created based off of Scatter Measurements provided in this manual. Refer to “typical HiRise Layout” towards the end of Chapter 5 of this manual for additional details.
- Keep exposure times to a minimum.
- The patient must wear a protective full wrap X-ray shielding apron (lead apron) during a scan unless the Hip or Pelvis are to be imaged. Patients less than 21 years old, small size patients (under 100 pounds) and children must also wear a gonad and ovarian front and back protective shield when appropriate for the anatomy being imaged. Sample shielding products, or similar:

Supplier: Marshield, Full Wrap Apron, #MS-SP1

Supplier: Universal Medical Inc, Diaper 14" x 20", #800

- Wear a PEN dosimeter and/or film badge.
- If you are required in the exam room during a procedure, stay as far from the scanner as possible or behind a protective wall.
- The physician is responsible for protecting the patient from unnecessary radiation.

System Description

The HiRise is a Computed Tomography X-ray system, or Cone Beam Volumetric Tomography x-ray system for 3D reconstruction Imaging, device for the upper and lower extremities and pelvis. The device also allows for imaging of Non-Weight Bearing Lower extremities using a supplied patient chair. The chair is intended to support the patient for non-weight bearing imaging when needed. The system is designed for an in-office setting with components consisting of the Scanner, Operating Computer (External Server), and Operator's Console. The system provides for patients to be imaged in weight bearing (standing) position as well as supine position for one or both feet and knees.

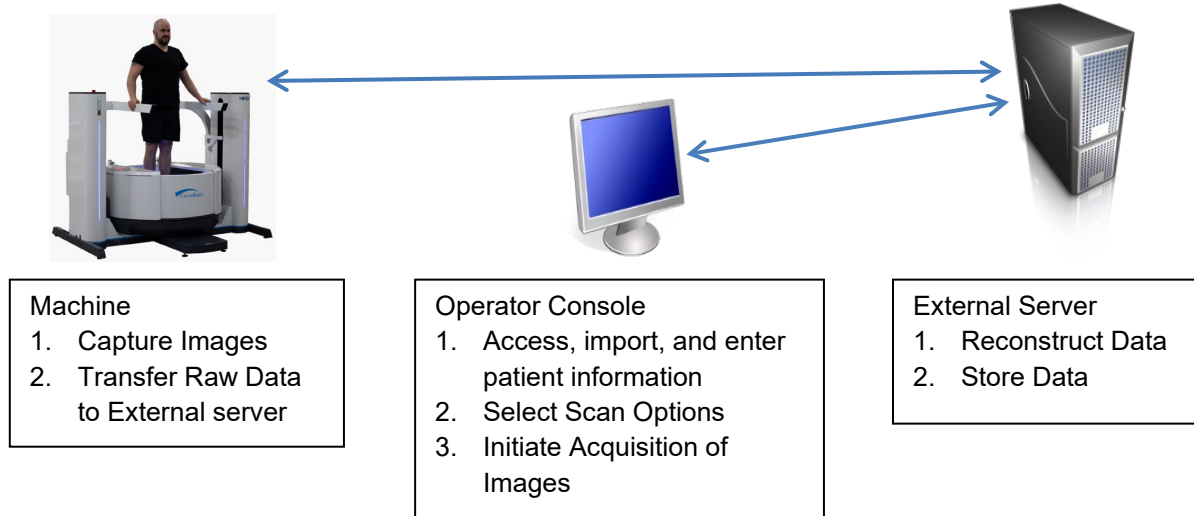

The External Server consists of 3 Virtual Machines:

ACQ VM: accessed via the Main Desktop icon on the Operator Console.

RECON VM: accessed via Remote Desktop Connection icon on the Operator Console.

Database VM: accessed via Remote Desktop Connection icon on the Operator Console.

Major Device Components

Scanner

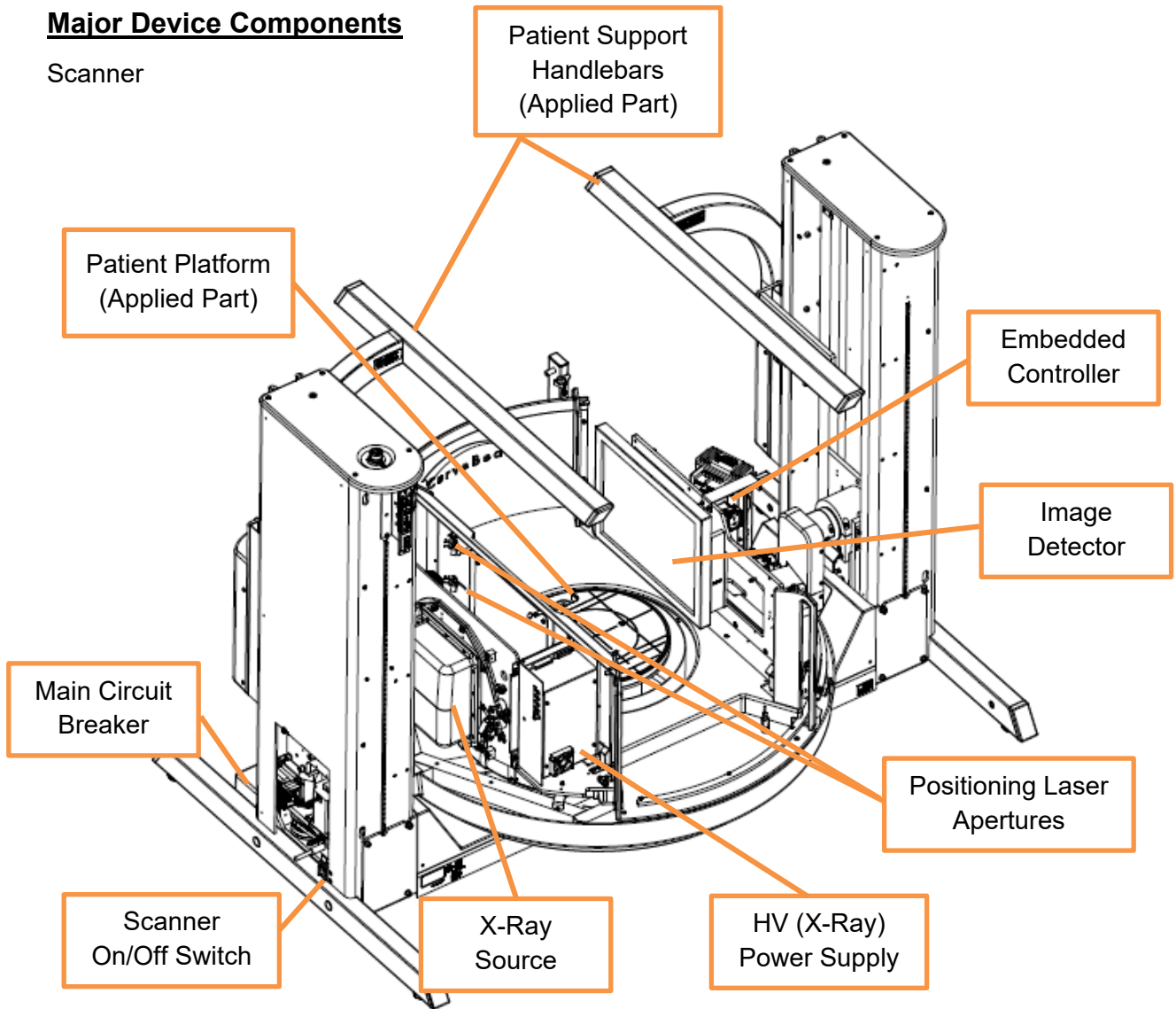

Patient Chair

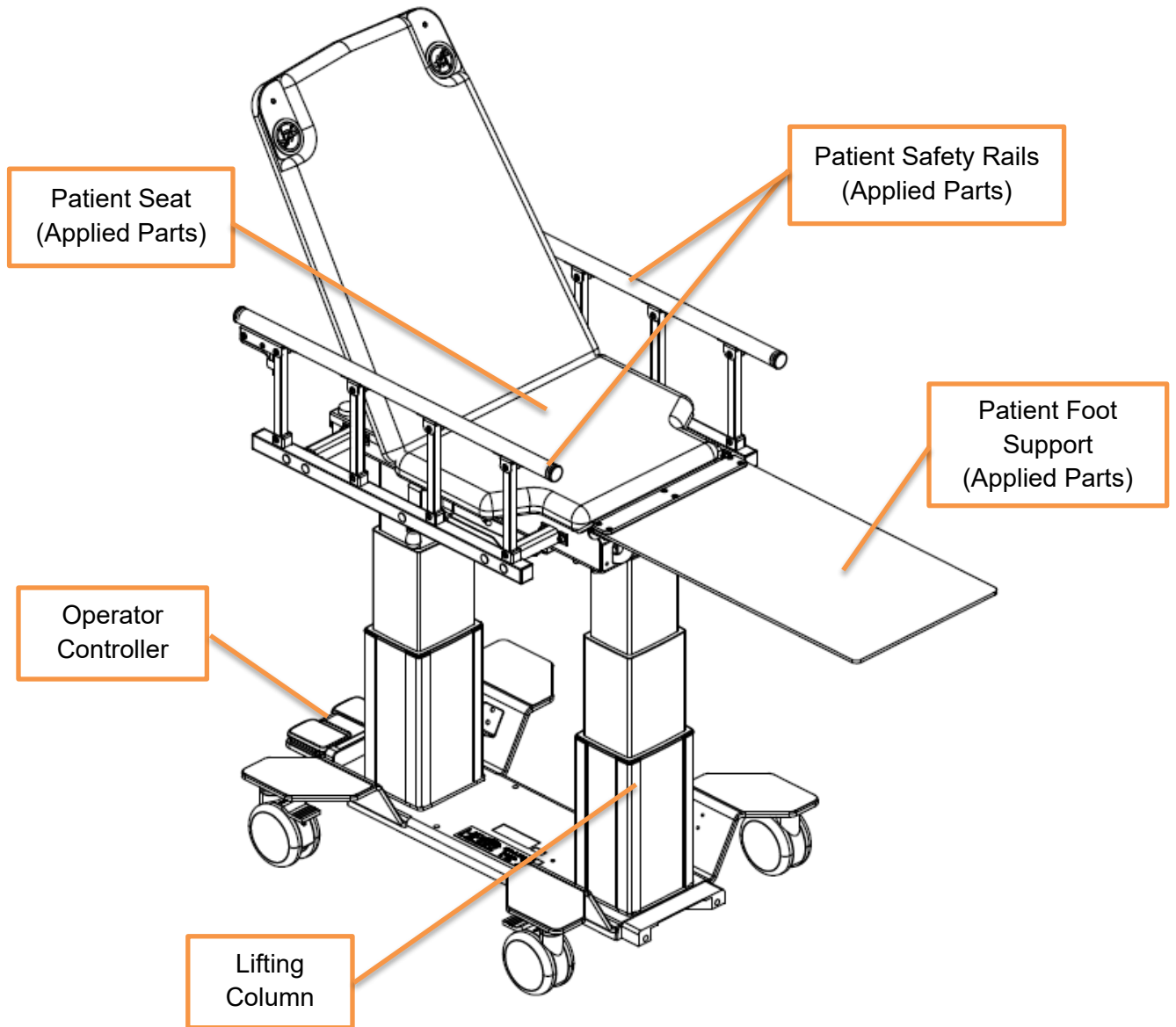

Intended Use of the Device

The HiRise is intended to be used for 3-D imaging of the upper and the lower extremities and pelvis of adult and pediatric patients weighing from 40 to 450 lbs.

The device is to be operated in a professional healthcare environment by qualified health care professionals only.

Major System Items

- Scanner
- Patient Chair
- Dell server with hard drives, network cards, DVD drive, etc and Uninterrupted Power Supply (UPS)
- External Cable Kit
 - Door Interlock, 50' (15.24 m)
 - Warning System, 50' (15.24 m)
 - Door interlock, shorting plug
 - Operator Control Box Assembly, 50' (15.24 m)
- Ethernet Cable, CAT6, gray, 50' (15.24 m) (QTY 2)
- Ethernet cable, CAT 6, green, 50' (15.24 m)
- Ethernet cable, CAT6, red, 50' (15.24 m)
- Power cord, 10' (3.05 m)
- Varex Imaging Flat Panel Detector, 4030DX
- X-Ray tube assembly
- X-Ray power supply

Intended User Profile

The HiRise is intended to be used by an operator that meets all local, state, federal or international regulations and that has been trained by CurveBeam personnel using the HiRise On Site Training Checklist.

Contraindications

This device emits ionizing radiation. Exposure to ionizing radiation may cause damage to cells and may increase the risk of cancer later in life. Populations sensitive to exposure include pediatric and those that are pregnant.

About the Operators' Manual

This documentation describes the safe and effective operation of the system. The information is intended to provide trained Technologists and Physicians with the necessary guidance to operate the system in a safe and effective manner.

CurveBeam assumes no liability for the use of this document if any unauthorized changes to the content or format have been made.

Conventions Used in the User Manual

Main Menu items and Tabs are in quotes (“ ”). Software Programs are in quotes (“ ”)

Interface buttons are capitalized” (BUTTON).

Warranty

CurveBeam Standard Warranty is available by request. Please contact CurveBeam Technical support to receive a copy of the Warranty.

CHAPTER 2: Product Information

Technical Specifications

Description	Specification
Tube voltage	100 kVp, 120 kVp, 130kVp, (+/-10%)
Tube current	5.5 mA, 6.5 mA (+/-10%)
Tube output exposure setting available	100kVp & 120kVp @ 5.5mA 130kVp @ 6.5mA
CBCT Scan time*	34 sec 58 sec for hip
CBCT Procedure time**	Foot/Feet (Gantry at bottom position): 86 sec Knees (Gantry at an elevated position): 120 sec Hips (Gantry at an elevated position): 195 sec Upper Extremity (Gantry in Tilted Position): 86 sec NWB Feet, Knees (Gantry in Tilted Position): 86 sec
CT Max exposure time (based on typical pulse width)	25.2 sec
Image detector	Amorphous Silicon
Gray scale	16 bit
CBCT Imaging Volume	7.87" (20.0 cm) height x 16.92" (43.0 cm) diameter, 7.87" (20.0 cm) height x 10.23" (26.0 cm) diameter
Typical slice thickness	0.3mm (+/-0.5mm); Slice Spacing 0.3 mm
Typical voxel size	0.3 mm
Measurement accuracy	± 2 voxel
Body parts scanned	Upper extremities, lower extremities, pelvis
Size of system: h x d x w	57"x58"x73" (145 cm x 147 cm x 185 cm)
Weight	Scanner 850 lb (385 kg), Patient Chair 220 lb (100 kg)
Power Requirements	920VA

*Scan time is defined as the duration in which the exposure alarm (buzzer) is ON and X-ray ON light is illuminated.

**Procedure time is from time the exposure button is pressed to when the door can be opened or the Patient Chair can be wheeled out of scanner after the scan.

X-ray Source:

Tube Voltage:	100 kVp(eff), 120 kVp(eff), 130 kVp(eff), +/- 10%
Tube Current:	5.5 mA, 6.5 mA +/- 10%
Voltage Wave Shape:	Constant Potential
Focal Spot:	0.0197 inches (0.5 mm)
Duty Cycle:	3%

Source to Sensor distance: 30.215" (76.747 cm)

Source to Patient distance: 19.837" (50.387 cm^{***})

***The patient must be properly positioned for all applications in order to have the focal spot to skin distance as large as possible.

Minimum Filtration (at 120 kVp(eff)) (mm of aluminum equivalent): 10 mm or greater

Maximum Rated Continuous Tube Operation: 130 kVp @ 0.5 mA

Maximum Rated Pulsed Tube Operation: 130 kVp @ 6.5 mA



NOTE: Leakage technique factors are measured at the maximum specified energy.

Timer: ± 0.1 seconds or 5%, whichever is greater

X-ray Beam Size: 11.7" (29.80 cm) height x 15.6" (39.70 cm) width.

Image Detector: Amorphous Silicon (readable area): 11.7" (29.80 cm) height x 15.6" (39.70 cm) width.

Sensor Front Panel Attenuation Value: Less than 1mm of aluminum equivalent (information for reference only)

CBCT Image Acquisition: 1 orbit, 360 degree rotation (maximum)

CBCT Field of View: 10.23" (26.0 cm) diameter x 7.87" (20.0 cm) height

CBCT Extended Field of View: (offset scan): 16.92" (43.0 cm) diameter x 7.87" (20.0 cm) height

Max Capture Height(Max Height of Accumeasure): 42 inches (106 cm)

Max FOV Height(Max Height of Anatomy capture): 47 inches (119 cm)

CBCT Patient options available for scanning:

Patient Parameters	Exposure Factors	Type
Small Size: Weight: 40 to 100 lbs (18.1-45 kg)	100 kVp, 5.5 mA	Medium Field (100kVp)
Small Size: Weight: 40 to 100 lbs (18.1-45 kg)	100 kVp, 5.5 mA	Large Field (100kVp)
Weight: 101 to 450 lbs (46-204 kg)	120 kVp, 5.5 mA	Medium Field (120kVp)
Weight: 101 to 450 lbs (46-204 kg)	120 kVp, 5.5 mA 130 kVp, 6.5 mA	Large Field (120kVp, 130kVp)

CBCT Primary Reconstruction:

- **Medium Field of View options:** Maximum 3 minutes
- **Large Field of View options:** Maximum 4 minutes

CBCT Secondary Reconstruction: Real Time

Gantry Stopping Distance and Angle: Total rotation from Home position to limit is 424 degrees (Home being 0 degrees). "Load" position (gantry aligned for patient to walk in) is home position.

Essential Performance:

As it relates to clinical functionality, the loss or degradation of the following performance specifications extending beyond the manufacturer specified operating limits could result in an unacceptable risk:

1. Unexpected movement could create an unacceptable risk.

Network Diagram

The HiRise system network is configured per the below image.

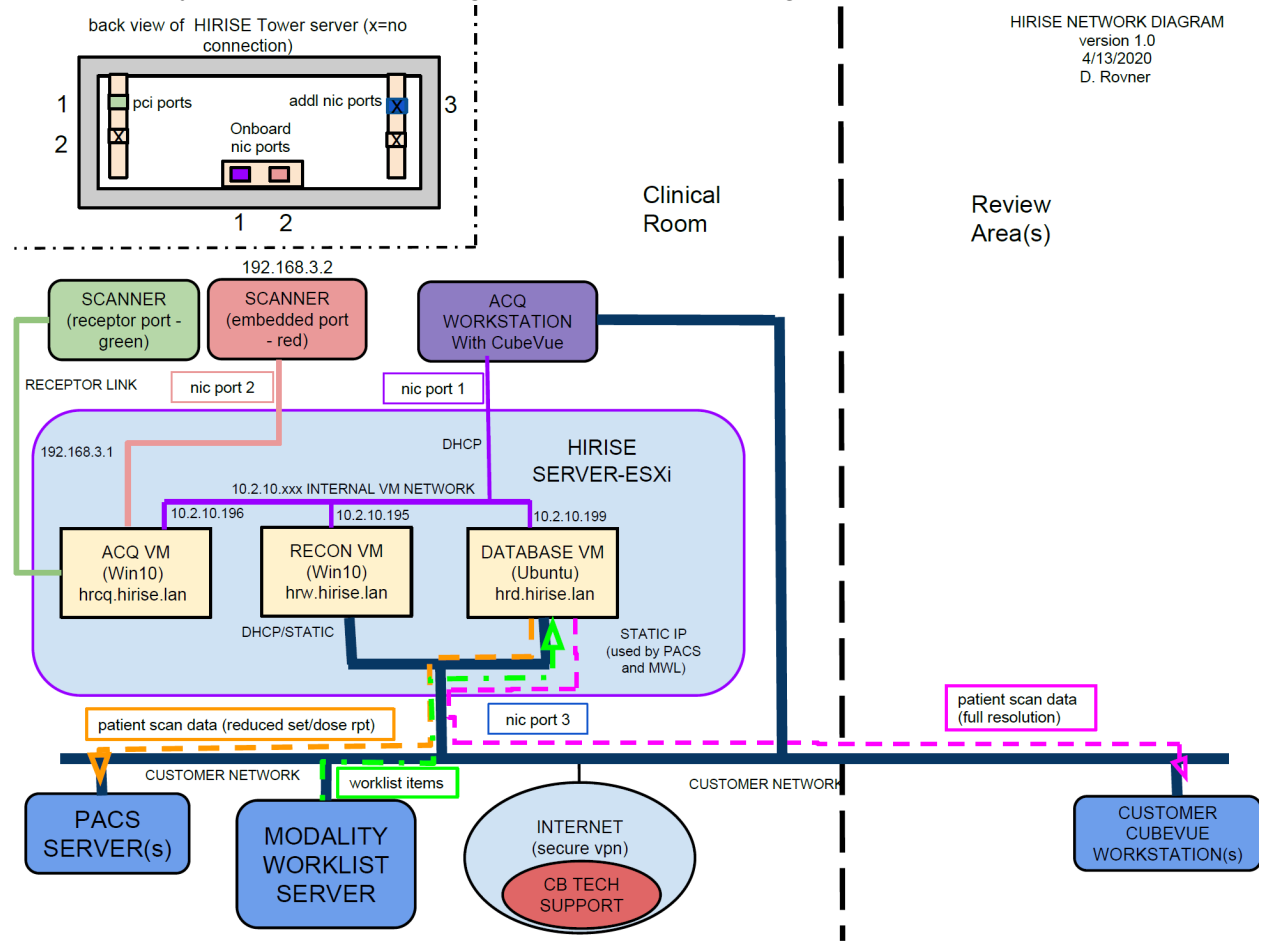

HIRISE NETWORK DIAGRAM
version 1.0
4/13/2020
D. Rovner

Power Requirements

The Scanner requires a Dedicated Line and/or Filtered Line. A Surge Protector is recommended. The Scanner is suitable for continuous connection to a power supply in stand-by mode.

Line Voltage: 115VAC \pm 10% (Factory Set)
230VAC \pm 10% (which covers 220, 230 and 240 VAC power supplies)
(Factory Set)

Line Current: 10 Amps (115V) or 5 Amps (230V)

Line Frequency: 50 Hz / 60 Hz

Phase: Single

Main Circuit Breaker:

- Voltage: 230VAC
- Current: 10 Amps
- Size: W28
- Breaking Capacity: 1000 Amps
- Operating Speed:
 - 100% - No Trip
 - 135% - Trip in 1 hour
 - 200% - 2.2-15.0 Sec.
 - 400% - 0.55-1.8 Sec.
 - 600% - 0.27-0.7 Sec.
 - 800% - 0.17-0.45 Sec.
 - 1000% - 0.12-0.3 Sec.

Nominal Electrical Input Power to Supply: CT Volume Scan = 660W (120kV, 5.5mA);
Scan Time has no effect on electrical power output.

Apparent Resistance of Supply Mains

For the purpose of obtaining the apparent resistance of supply mains, resistance is determined according to the following formula:

$$R = \frac{U_0 - U_1}{I_1}$$

Where:

U0 is the no-load Mains Voltage

U1 is the Mains Voltage under load.

I1 is the Mains Current under load.

Circuit Breaker Assembly	U0	U1	I1	Apparent Resistance
115VAC	115.4VAC	114.2VAC	2.1A	0.57ohms
230VAC	230.8VAC	228.0VAC	1.2A	2.33ohms

Environmental Specifications

Operating:

- The operational temperature range shall be 59°F to 86°F (+15°C to +30°C).
- The operational humidity range shall be 25 to 60% relative humidity, non-condensing.
- The minimum time period that the room environmental operating conditions must be maintained prior to powering the system is 1 hour.
- The operational atmospheric pressure range shall be 94 kPa to 102 kPa.

Transportation and Storage:

- The storage and transport temperature range shall be -4°F to 122°F (-20°C to +50°C).
- The storage & transport humidity range shall be 10% to 95% relative humidity, non-condensing.

Scanner and Acquisition Computer (server):

- Requires a Dedicated Line and a Surge Protector is recommended.

Patient Platform:

- Maximum patient weight capacity: 450 lbs. (204 kg)

Handlebars:

- Maximum weight capacity: 35 lbs. (45 kg)

Patient Chair:

- Maximum patient weight capacity: 450 lbs. (204 kg)

Environmental Impact:

The HiRise display monitors can be powered off when not in use, to minimize power consumption and environmental impact.

The HiRise scanner can be powered off when not in use, refer to the System Startup requirements listed in Chapter 6 before deciding to turn the scanner off, to minimize power consumption and environmental impact.

! **CAUTION:** Before powering off the HiRise scanner, be aware of the time requirement needed when powering up the HiRise scanner.

There are no options or adjustments the user can perform to minimize environmental impact during normal operation.

Disposal:

Follow local regulations on disposal of waste parts. The *X-ray source assembly, image sensor* and *all electronic circuits* should be regarded as non-environmentally friendly waste product. The system does not generate, or require the use of, any materials that require special disposal instructions as part of regular operation.

Extension Cords:

Do not use any extension cords which are not provided with the system. Be aware that multiple portable socket outlets or extension cords are not to be connected to the system.

External Items: Do not connect any items or equipment to this system which are not part of the system.

Multiple Socket Outlet: The UPS (Uninterruptible Power Supply) included in this system is considered a multiple socket-outlet (MSO).

- Maximum permitted Load is 1500VA
- The MSO is intended to supply power to the commercial equipment used to interface with the HiRise only. This includes the server, acquisition terminal, and the monitor.
Do not connect the HiRise to the MSO.
- Connecting the supplied commercial equipment directly to the wall outlet increases the risk of a sudden shutdown of the server. A sudden server shutdown can leave the software in an unknown state and prevent successful startup. The server should be shutdown via software when at all possible.
- Equipment not supplied as part of the system should, under no circumstances, be connected to the MSO. The MSO has been selected and evaluated for the requirements of this system. Connecting unknown additional equipment may cause risks not evaluated by CurveBeam.

Instruction for maintaining BASIC Safety and Essential performance for the expected Service life

NOTE: Do not change the once installed final application due to EMC, view Immunity test levels (IEC 60601-1-2:2014)

Electromagnetic or other Interference (Emissions and Immunity)

The system was tested and it was determined to meet the class A (non-residential) limits. The system pass testing with a reduced level of compliance with the criteria contained in IEC 60601-1-2 Edition 3 Issued 03/2007 and IEC 60601-1-2 Edition 4 issued 02/2014.

Test Name	Test Level/ Equipment Class Edition 4	Results/Notes	Immunity Performance Criteria Met
Radiated Emissions	Class A: Group 1	Compliant	-
Conducted Voltage Emissions	Class A: Group 1	Compliant	-
IEC61000-3-2 Harmonic Current Emissions	Class A	Compliant	-
IEC61000-3-3 Voltage Changes, Voltage Fluctuations and Flicker	Dmax = 4 %	Compliant	-
61000-4-2 Electrostatic Discharge	±8 kV Contact, ±15 kV Air	Compliant	A
61000-4-3 Radiated Immunity	80 MHz – 2.7 GHz, 3 V/M, 80% AM with 1kHz See Table 9 below for complete list	Compliant	A
61000-4-4 Electrical Fast Transients	100kHz repetition ±2 kV Power Supply Lines, ±1 kV Input/Output Lines	Compliant	A
61000-4-5 Surge Immunity	±1 kV Line to Line, ±2 kV Line to Earth	Compliant	A
61000-4-6 Conducted Immunity	150 kHz – 80MHz, 3 Vrms 6 Vrms in ISM band between 0.15 MHz and 80 MHz 80 % AM at 1 kHz	Compliant	A
61000-4-8 Power Frequency Magnetic Field	30 A/M	Compliant	A
61000-4-11 Voltage Dips and Short Interruptions	135°, 180°, 225°, 270° and 315° % UT; 1cycle 70 % UT; 25/30 cycles for 50 Hz and 60Hz, % UT; 250/300 cycle for 50 Hz and 60 Hz	Compliant	A
		Compliant	A
		Compliant	A
		Compliant	C
61000-4-11 Voltage Dips and Short Interruptions	135°, 180°, 225°, 270° and 315° % UT; 1cycle 70 % UT; 25/30 cycles for 50 Hz and 60Hz, % UT; 250/300 cycle for 50 Hz and 60 Hz	Compliant	A
		Compliant	A
		Compliant	A
		Compliant	C

Table 9 – Test specifications for ENCLOSURE PORT IMMUNITY to RF wireless communications equipment

Test frequency (MHz)	Band ^{a)} (MHz)	Service ^{a)}	Modulation ^{b)}	Maximum power (W)	Distance (m)	IMMUNITY TEST LEVEL (V/m)
385	380 – 390	TETRA 400	Pulse modulation ^{b)} 18 Hz	1,8	0,3	27
450	430 – 470	GMRS 460, FRS 460	FM ^{c)} ± 5 kHz deviation 1 kHz sine	2	0,3	28
710	704 – 787	LTE Band 13, 17	Pulse modulation ^{b)} 217 Hz	0,2	0,3	9
745						
780						
810	800 – 960	GSM 800/900, TETRA 800, iDEN 820, CDMA 850, LTE Band 5	Pulse modulation ^{b)} 18 Hz	2	0,3	28
870						
930						
1 720	1 700 – 1 990	GSM 1800; CDMA 1900; GSM 1900; DECT; LTE Band 1, 3, 4, 25; UMTS	Pulse modulation ^{b)} 217 Hz	2	0,3	28
1 845						
1 970						
2 450	2 400 – 2 570	Bluetooth, WLAN, 802.11 b/g/n, RFID 2450, LTE Band 7	Pulse modulation ^{b)} 217 Hz	2	0,3	28
5 240	5 100 – 5 800	WLAN 802.11 a/n	Pulse modulation ^{b)} 217 Hz	0,2	0,3	9
5 500						
5 785						
<p>NOTE If necessary to achieve the IMMUNITY TEST LEVEL, the distance between the transmitting antenna and the ME EQUIPMENT or ME SYSTEM may be reduced to 1 m. The 1 m test distance is permitted by IEC 61000-4-3.</p>						
<p>^{a)} For some services, only the uplink frequencies are included.</p> <p>^{b)} The carrier shall be modulated using a 50 % duty cycle square wave signal.</p> <p>^{c)} As an alternative to FM modulation, 50 % pulse modulation at 18 Hz may be used because while it does not represent actual modulation, it would be worst case.</p>						

 **WARNING** This system is intended for use by healthcare professionals only. This system may cause radio interference or may disrupt the operation of nearby equipment. Follow the following recommendations below.

Recommended separation distances between portable and mobile RF communications equipment and the HiRise

The HiRise is intended for use in an electromagnetic environment in which radiated RF disturbances are controlled. The customer or the user of the HiRise can help prevent electromagnetic interference by maintaining a minimum distance of 10 feet (3 m) between portable and mobile RF communications equipment (transmitters) and the HiRise. Refer to the portable and mobile RF communications equipment user's manual for recommended clearance distances to other equipment based on the maximum output power of the communications equipment. Maintain a minimum distance of 10 feet (3m) between the HiRise and portable and mobile RF communication equipment, otherwise, degradation of the performance of this equipment could result. Other cables and accessories may affect EMI performance. Use of this equipment adjacent to or stacked with other equipment should be avoided because it could result in improper operation. If such use is necessary, this equipment and the other equipment should be observed to verify that they are operating normally. Use of accessories, transducers and cables other than those specified or provided by the manufacturer of this equipment could result in increased electromagnetic emissions or decreased electromagnetic immunity of this equipment and result in improper operation. This equipment is designed to be used in industrial areas and hospitals (CISPR 11 class A) only. Therefore, the emissions characteristics have not been tested to comply with CISPR 11 group 2 Class B. This equipment is not suitable for use If it is used in a residential environment (for which CISPR 11 class B is normally required) this equipment might not offer adequate protection to radio-frequency communication services. The user might need to take mitigation measures, such as relocating or re-orienting the equipment.

Equipment Standards

The HiRise has been designed with radiation protection in accordance with IEC 60601-1-3:2008.

The HiRise has been designed and evaluated to meet the requirements of the following standards. The device has passed all applicable sections of these standards.

AAMI IEC 60601-1:2005+AMD1:2012+AMD2:2020 CSV
IEC 60601-1-2:2014+AMD1:2020 CSV
IEC 60601-1-3:2008+AMD1:2013+AMD2:2021 CSV
IEC 60601-1-6:2010+AMD1:2013+AMD2:2020 CSV
IEC 62304:2006/AMD 1:2015
IEC 60601-2-44:2009+A1:2012+A2:2016
IEC 60825-1:2014
IEC 62471-5:2015
IEC 61223-3-5:2019
IEC 62366-1:2015
ISO 15223-1:2021
BS EN ISO 14971:2019

Equipment Class

- Protection against electric shock: Class I
- Applied part has degree of protection against electric shock: Class B
- Class of equipment against ingress of liquids: Ordinary Equipment: IPX0
- Radiated emissions: Class A

Regulatory Class

Governing Body	Classification
FDA	2
Health Canada	3
EU MDR 2017/745	IIb

Cleaning

 **WARNING** Prior to performing any cleaning, ensure the machine is not in use, and patient is not in the scanner.

Routinely and after each patient scan, clean and disinfect all items which could come in contact with the patient. As stated in patient preparation recommendations below, barriers should be used so that the patient does not come into direct contact with the device. By avoiding direct contact with the device, minimal soiling should occur during normal use.

Cleaning the equipment frequently, especially if corroding chemicals are present is a function of the Operator. Unless otherwise instructed, use a cloth moistened with warm water and mild soap. Do not use strong cleaners and solvents as these may damage the finish. Be careful when cleaning to avoid liquid leaking underneath the Platform Area and into the Gantry.

For disinfecting, use CaviWipes™ or CaviWipes1™ surface disinfectant wipes by Metrex™. Use on all surfaces that contact the patient as directed by the label. Do not spray any disinfectant directly onto the equipment.

Patient Preparation Recommendations

The patient must wear FDA cleared medical gloves for gripping the handrails, with sanitation and convenience in mind.

The patient should not step bare foot on the patient platform. Proper foot protection should be provided.

The Patient Chair should be lined with Exam Table Paper before the patient is seated on it.

Line the patient stabilizer or hand platform (if using) with Medical Barrier Film. CurveBeam tested brand: Clear Barrier Film – Low tack-adhesive (Palmero #1866C).

After each patient scan, clean and disinfect all items which came in contact with the patient including the patient chair, patient support handlebars, patient platform, knee and hand positioners, shielding, and other patient positioning devices.

Preventive Maintenance Schedule - for Owner / User

 **WARNING** Prior to performing any maintenance, ensure the machine is not in use, and patient is not in the scanner.

Daily:

- Routine Dusting - all surfaces.
- Clean and Disinfect all items which come in contact with the patient after each patient scan.

Monthly:

- Clean/Disinfect all surfaces, check for failed/faulty indicator lights.

Annually:

- Panel Calibration.
- Quality Assurance Procedure to check for satisfactory image quality.
- Periodic system testing by factory trained Service Technician.

IT IS THE RESPONSIBILITY OF THE USER TO ENSURE THAT THE EQUIPMENT IS MAINTAINED IN COMPLIANCE WITH THE MANUFACTURER'S RECOMMENDED MAINTENANCE SCHEDULE. THE MANUFACTURER AND THE ASSEMBLER / INSTALLER ARE RELIEVED FROM RESPONSIBILITY IN THOSE CASES WHERE NON-COMPLIANCE WITH THE STANDARD RESULTS FROM THE USER'S FAILURE TO HAVE THE MANUFACTURER'S RECOMMENDED MAINTENANCE PERFORMED.

The actual maintenance inspection and consequent service must be accomplished either by an authorized factory trained technician or by a competent serviceman of the user's choice who has adequate training in those aspects of the Performance Standards of the Radiation Control for Health and Safety Act of 1968 that are applicable to this equipment. Neither the inspection nor service is part of the equipment warranty. (To be arranged for by the Owner or User with the Dealer's Service Department).

Planned Maintenance – Monthly Schedule

The system requires monthly maintenance check for failed or faulty indicators/lights. Check for failed or faulty indicators/lights. Contact CurveBeam Technical Support at the number on the front cover of this manual to assist with exercising the indicators/lights.

Planned Maintenance - Annual Schedule

The system requires normal periodic inspection and maintenance. Scheduled periodic inspections are necessary to detect problems which can result from excessive wear, loose items, chafing wires, and mis-adjusted parts from continual system use. Scheduled panel calibrations are necessary to determine if the image quality is suboptimal. The scan results may have symptoms of artifacts commonly referred to as “circle or ring artifacts”. Below are samples of circle artifacts in scan results. If these are observed then a panel calibration should be performed.

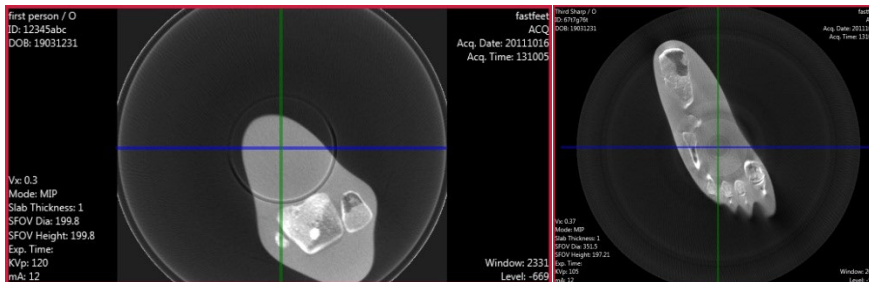

In addition to mechanical inspection and panel calibration, a series of image performance tests, including Quality Assurance Procedure, are to be conducted. Door interlock, LED status lights, emergency stop, laser operation and safety, x-ray alarm, movement switches, and patient positioner switches are also tested as part of this maintenance. Planned maintenance is to be performed annually by a factory trained Service Technician. If there are any questions regarding the annual maintenance, please contact CurveBeam Technical Support.

UPS (Uninterruptible Power Supply) Maintenance

Please refer to the Tripp Lite UPS (SMART1500LCDT 120v 1500va 900w and SMX1500LCDT 230V 1.5kVA 900W) User’s Guide for UPS maintenance recommendations.

Cyber Security Recommendations

CurveBeam uses commercially available software in the device that may be susceptible to unintended installation of malware or other malicious software that could compromise the full functionality of the device. Therefore, it is highly recommended that steps be taken to protect against possible vectors of infection. An industry standard, commercially available, active monitoring program such as anti-malware and antivirus program should be installed to protect the device against such attacks. Other protections such as strong security policies, access control policies, and strong network protection including the use of hardware and software firewalls are recommended in addition to active monitoring, in order to avoid infection or otherwise unintended consequences related to infection. It is important to protect the equipment from unauthorized access, unauthorized software, and insecure network access. Failure to sufficiently protect the equipment from possible attacks may result in unintended consequences including failure of the device.

Replacement Parts

Part Description	Part Number
Gantry Belt	200145-3
Lift Belt 1	A 6R 4-045050
Lift Belt 2	A 6R 4-240050
Lift Belt 3	A 6R 4-151050
Lift Motor	24000-10-2
Lift Motor Driver	24000-10-1
Gantry Rotation Motor	2400-10-7
Beam Limiter Motor	3364
Receptor Motor	24000-10-8
Mains PCBA	4034-1-0
Can Driver PCB	4033-0
X-Ray Power Supply Assembly	4016-0
Embedded Board Assembly	4014-0
Can Bus Breakout Assembly	4006-0
120VAC Breakout Assembly	4017-0
X-Ray Tube head	2027-0
Image Receptor (Panel)	4030DX
Operator's Control Box	5006-0
Scan (Exposure) Switch	5007-0
Geometric Phantom	2812-0
QA Phantom	2802
Patient Chair Lift Controller	24100-7
Patient Chair Lift Column	214100-10
Flat Platform Assembly	24000-20-0
Single Foot Platform	210-75-0
Knee Plate Assembly	24000-31-0
Hand Plate Assembly	24000-22-0
AccuMeasure	24000-50-0
Chair Lift Battery	24100-8

Accessories

Patient Non-Weight Bearing Chair
Non-Weight Bearing Chair Guide
Non-Weight Bearing Chair FOV Support
Patient Platform
Patient Stabilizer
Single Foot Platform
Gantry Shield (2)
Upper Extremity Positioner
Upper Extremity Shield
Flexible Shields (2) Top and Bottom (for upper extremity scans)
Patient Step
Calibration Kit

System Dimensions

Scanner:

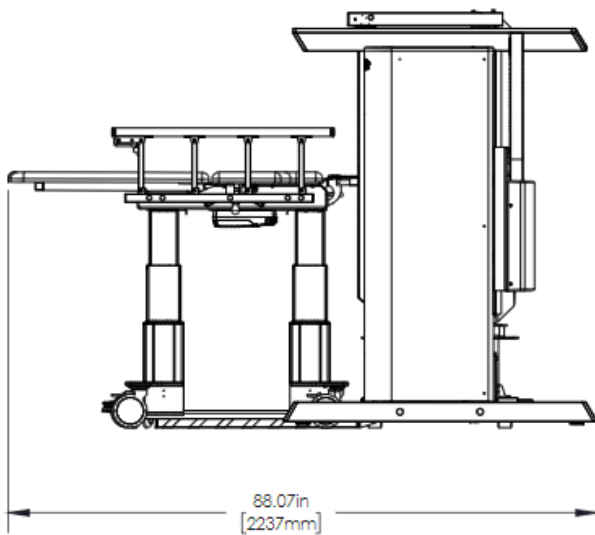
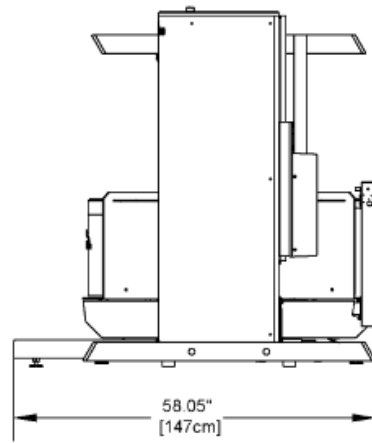
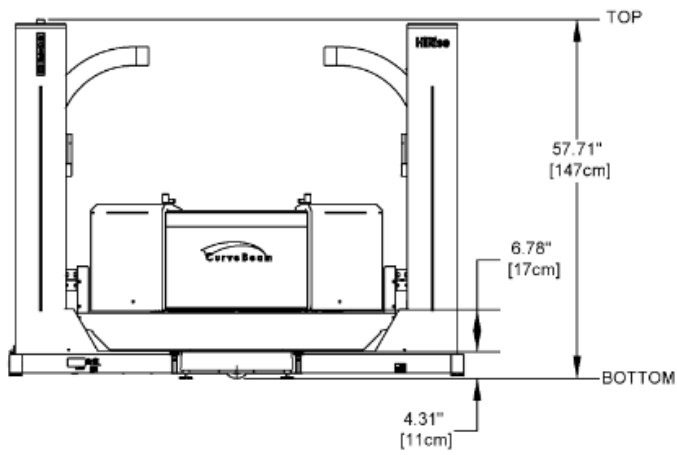
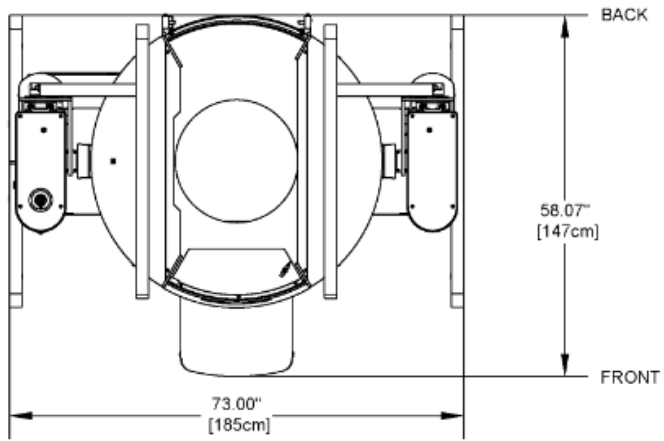

Non-Weight Bearing Patient Chair:

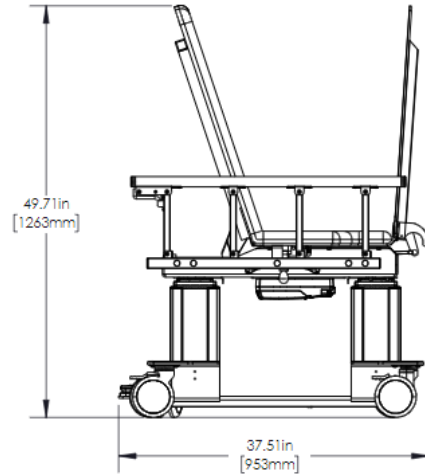
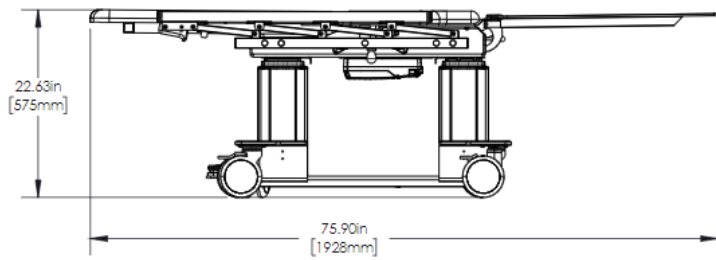
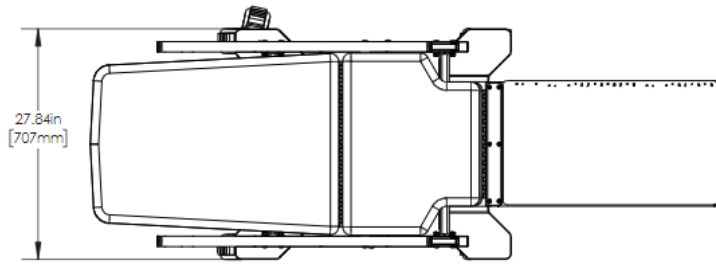

CHAPTER 3: Safety Items

In order to maintain the safety of patients and operators of this device, it is important to operate and maintain the system correctly, following all instructions, warnings, cautions in this manual and labeling on the system itself.

System Safety Devices

Emergency Stop: In the event of an emergency (any moving component collides with any parts of the equipment or items in the environment, or that could cause physical injury to the Patient), the Operator or Patient should utilize one of the 2 designated Emergency Stop (E-Stop) buttons to turn off the power to the X-ray and all moving parts in order for the Patient to be safely removed from the machine. There is an Operator E-stop button on the Operator Control Box and there is a Patient E-Stop button on the machine. The Emergency Stop (s) when activated will remove ALL power from the machine. If an E-Stop is activated, with a patient in the scanner, refer to the Emergency Removal of a Patient Section later in this chapter.

Moving Parts(over-travel): In the event of the use of either of the 2 designated Emergency Stop buttons or in any case where mains power is unintentionally interrupted, and the gantry is in motion, gantry shall stop within the limits defined below:

Gantry Rotational Movement	90 degree or less
Gantry Vertical Movement.	1 cm or less
Gantry Tilt Movement	2 degree or less

Warning System: The System is equipped with provisions for warning lights and/or audible alarms when X-ray power is energized. An externally powered Warning System can be connected to the cable provided which is capable of 250 volts, 50/60 hertz, and 1 amp. When X-ray power is energized the warning system is also energized.

Interlock System: This System is equipped with provisions for an Interlock Circuit which, when opened, will turn off X-ray power. This is a low voltage circuit, 5 volts DC. To use the Interlock Circuit, disconnect the factory installed Shorting Plug. Connect the supplied Interlock Cable to the scanner. Connect door switches (NO/COM terminals) and/or emergency stop switches (NC/COM terminals) in series between the other end of the Interlock Cable wires. Multiple door switches and/or emergency stop switches can be connected as long as the devices are connected in series. The entire circuit must be a closed loop when all of the doors are closed and/or emergency stop switches are in their normally closed state.

Whenever the door switch or switches are opened, or emergency stop button(s) pressed the X-ray power will be turned off. X-ray power cannot be turned on when the interlock circuit is open.

Interlock and Warning System Schematic:

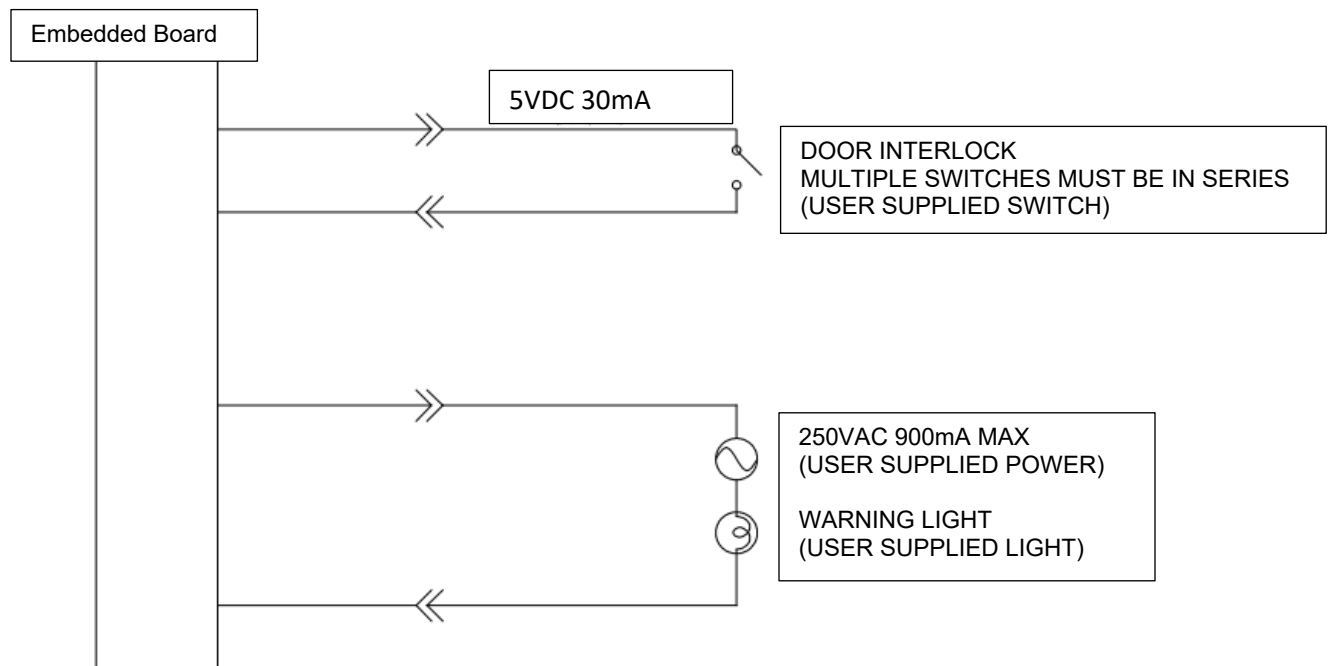

Emergency Removal of a Patient

The system has undergone extensive testing of the mechanical, electrical, and software performance, but if an unexpected occurrence is observed and/or the software locks up during a scan or an emergency arises where it becomes necessary to interrupt a scan and/or remove a patient from the system before a scan is completed, please follow these steps:

Press the EMERGENCY STOP button. This will halt the X-ray as well as all motion of the machine. An error message will appear in the Acquisition software. Always remove the patient from the machine after the EMERGENCY STOP button has been used.

For Weight Bearing Scan Removal:

1. If the gantry is raised around the patient, use the brake on the left side of the machine to lower the gantry.
2. Manually rotate the gantry so that the patient entrance (side with the small step down) is at the front of the scanner.
3. Open the Patient Door.
4. Assist the patient to step out of the platform area and away from the scanner.

For Upper Extremity and Patient Chair Scan Removal:

1. Remove patient as if the scan has been completed.

Once the patient has been removed from the scanner:

Close the Acquisition software (if not already). Release the E-stop by turning the knob to the right until it pops up. Then turn the machine power back ON at the Main Circuit Breaker. Re-launch the Acquisition software. Now the system can be operated again as expected.

In the case of loss of power to the scanner, perform the numbered steps above. Once power is restored, the instructions listed under “Once the patient has been removed from the scanner” can be performed, with e-stop release only required if e-stop was pressed.

Recommended Coverings

The following table provides a reference to the recommended coverings.

Item	Manufacturer	Part number	Description	Certificates
Gloves - Clear Vinyl Powder Free Exam Gloves	AMMEX	VPF6X100 The above "X" is dependent upon the size required.	"Dependable barrier protection against blood-borne pathogens and environmental contaminants " "Ambidextrous, FDA approved for all non-sterile medical procedures"	K891850
Barrier Film – Clear Film	Palmero Medical	1866C	"Polyethylene film with a low-tack adhesive that adheres to most operatory surfaces, leaves no residue, latex-free"	Safety Data Sheet provides Toxicology Information.
Exam Paper – Standard Crepe Exam Table Paper	MEDLINE	NON23325	"Strong, absorbent table paper helps protect exam tables from dirt and moisture while offering comfort and protection for patients."	Latex Free

Throughout the course of the manual, images of the device may be shown without the recommended coverings to provide a better visual for explanation purposes. It is recommended that these coverings be used at all times when using the HiRise device.

System Labels

Operator Control Box Label: E-Stop, Power ON light, X-ray Ready light, X-ray ON light, Fault light, Scan/Exposure Switch.

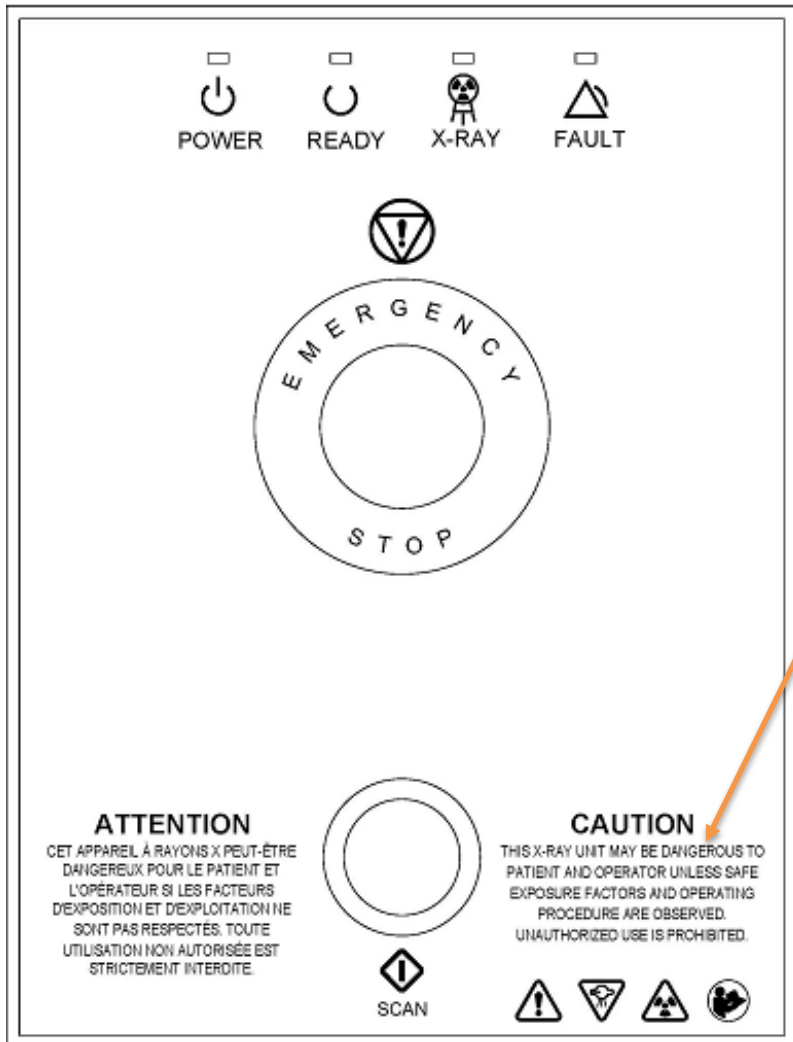

Zoomed in on the Verbiage:
CAUTION
THIS X-RAY UNIT MAY BE DANGEROUS TO PATIENT AND OPERATOR UNLESS SAFE EXPOSURE FACTORS AND OPERATING PROCEDURE ARE OBSERVED. UNAUTHORIZED USE IS PROHIBITED.

HiRise Name Label:



Location Label:

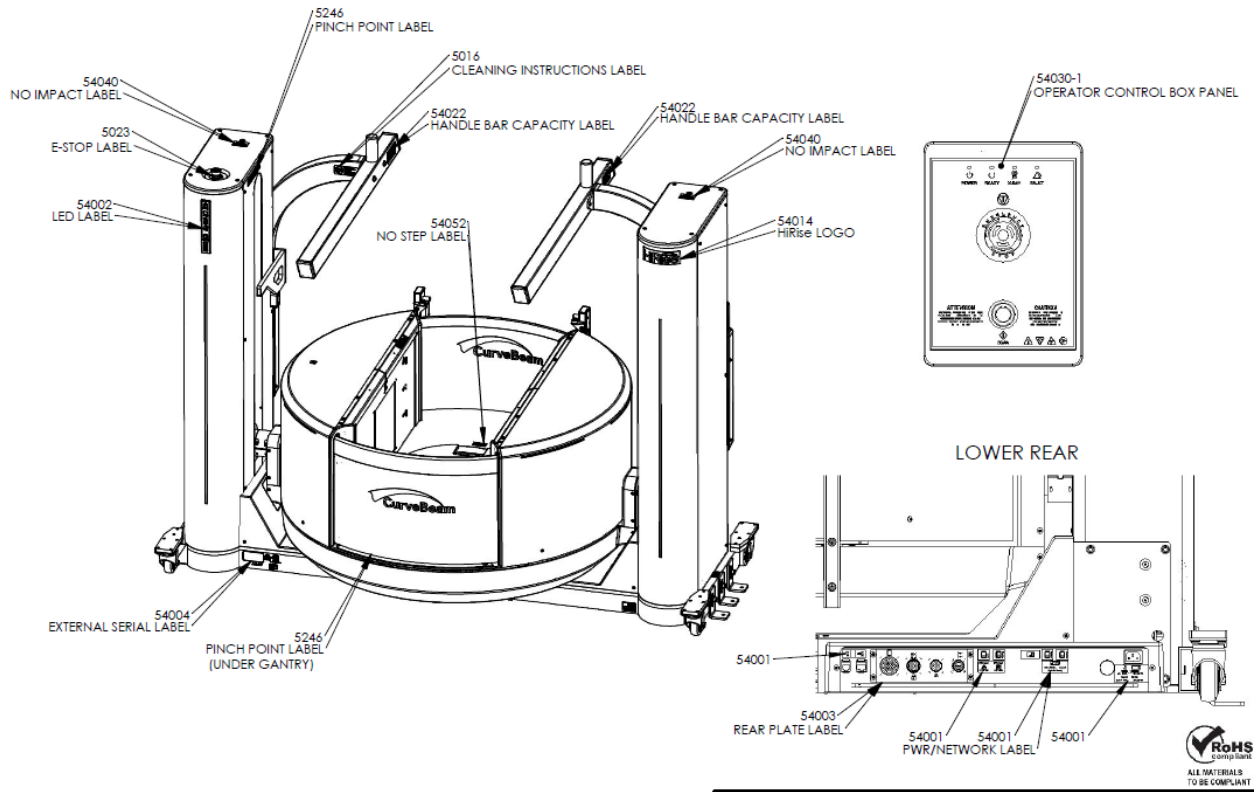

Front Cover:

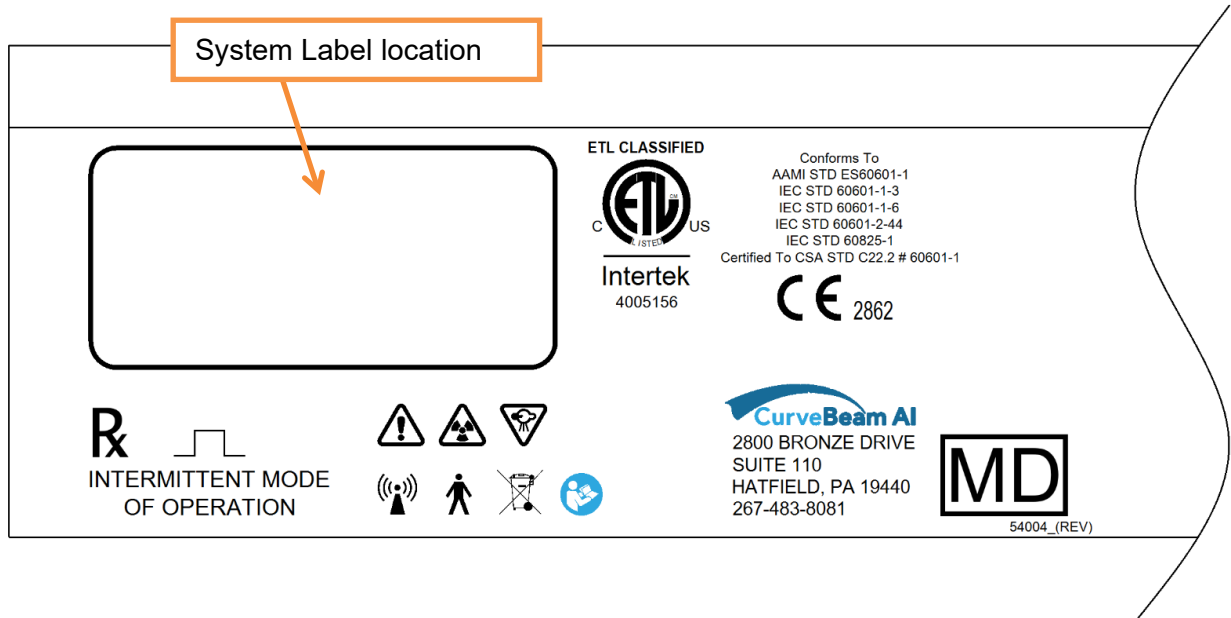

System Label:





Depending on description, the following may be in this field:

- HiRise
- X-Ray Power Supply
- Beam Limiter
- Control Box

CurveBeam LLC.

This product complies with DHHS standards under the Radiation Control Act of 1968 applicable at date of manufacture. This product complies with 21 CFR 1020.30 – 1020.31

(see description on left)

 (YYYY-MM)		(01)XXXXXXXXXX
 (Model No)		(21)XXXXXX
 (Serial No)		







Manufactured by CurveBeam LLC.
2800 Bronze Dr. Hatfield, PA 19440 USA

5008_(REV)

Tube Head Label:

CurveBeam LLC.

This product complies with DHHS standards under the Radiation Control Act of 1968 applicable at date of manufacture. This product complies with 21 CFR 1020.30 – 1020.31

<p>Tube Head Assembly</p>  (YYYY-MM)  (Model No)  (Serial No)	<p>X-Ray Tube</p>  Superior x-Ray  SXR-130-15-0.5  (Serial No)
---	--

130kVp, 6.5mA  10.5mm Al, fs 0.5mm

Manufactured by CurveBeam LLC.
2800 Bronze Dr. Hatfield, PA 19440 USA

5008_(REV)

Tubehead Focal Spot Label:

Focal Spot



5027_(REV)

Rear Connector Panel Label:

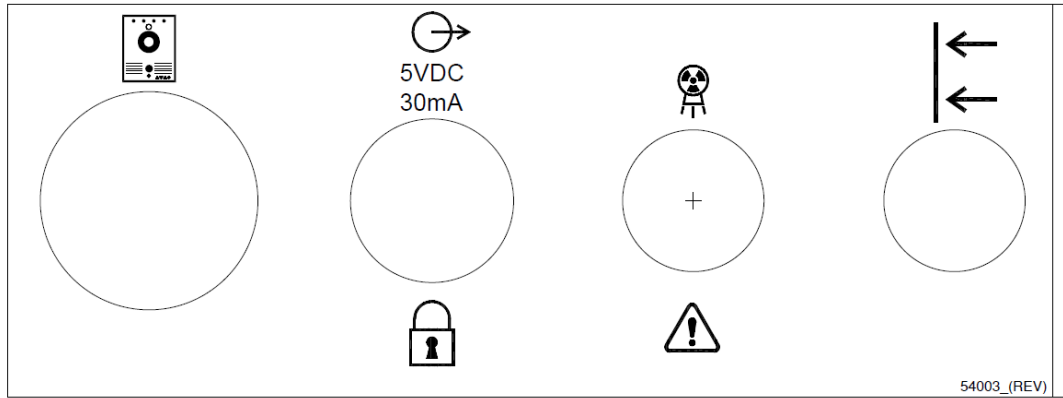

Rear Connections Label:

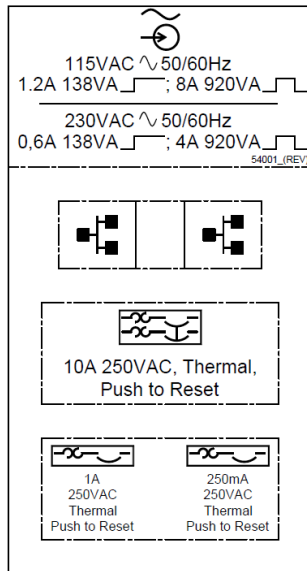

Voltage Nameplate Label:

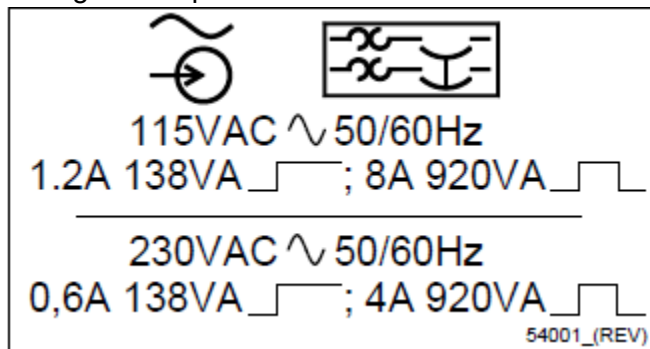

Indicator Panel Label (on machine):



Motion Button Label:

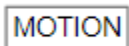

X-Ray Warning Label:

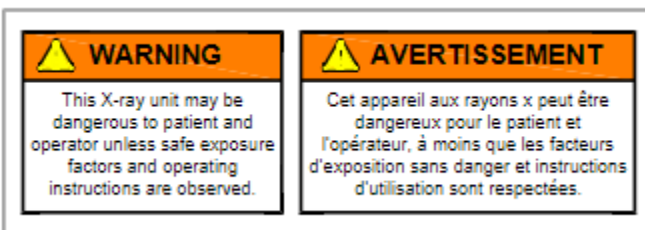

Laser Warning:

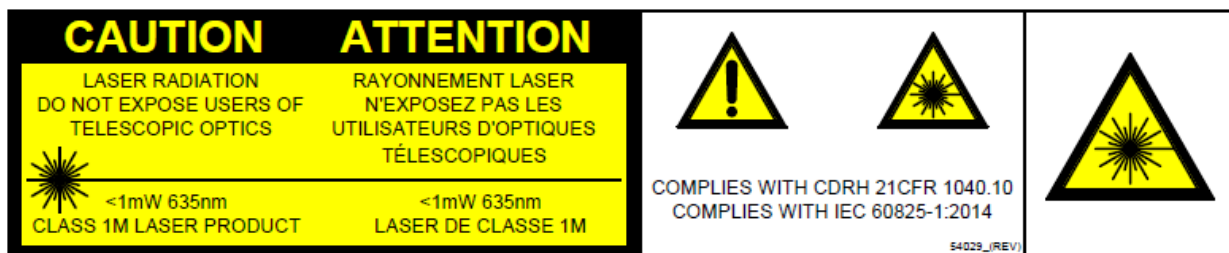

Handlebar Label:

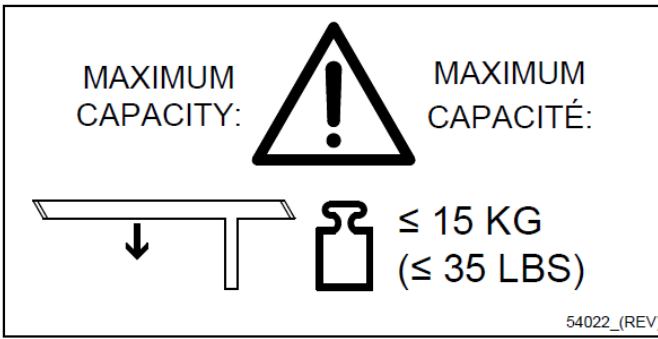

Cleaning Instructions Label on Scanner and Patient Chair:

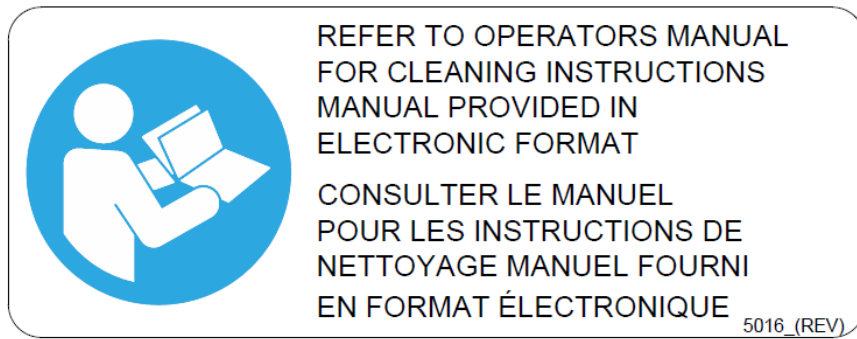

Pinch Point Label on Scanner and Patient Chair:

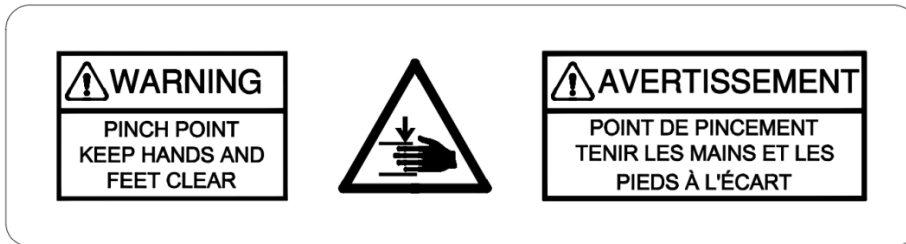

Pinch Point Label on Scanner:

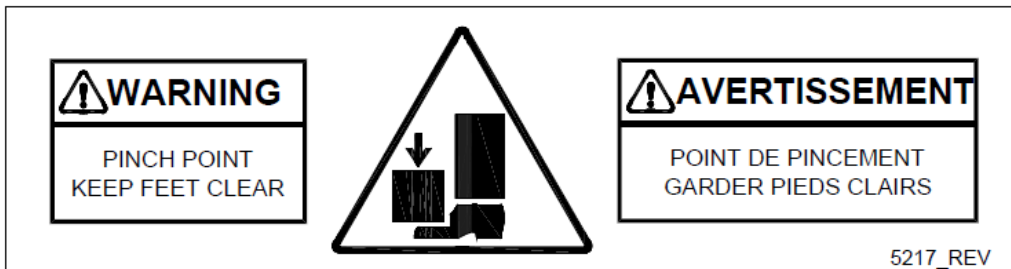

Patient Platform Label:

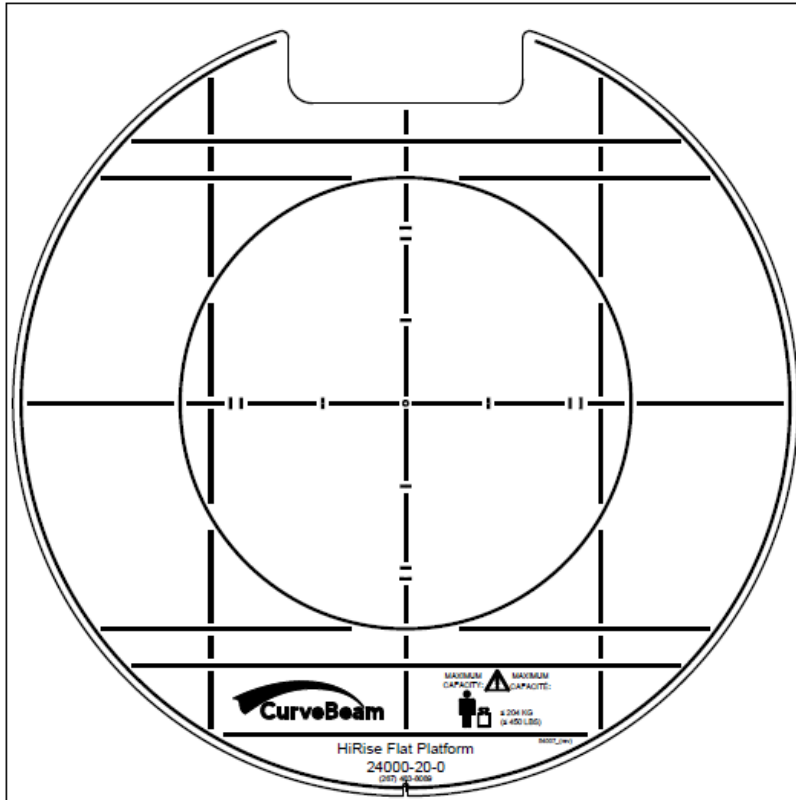

AccuMeasure Label:



AccuMeasure Pointer Labels (Knee and Hip):



Step Assembly Label:

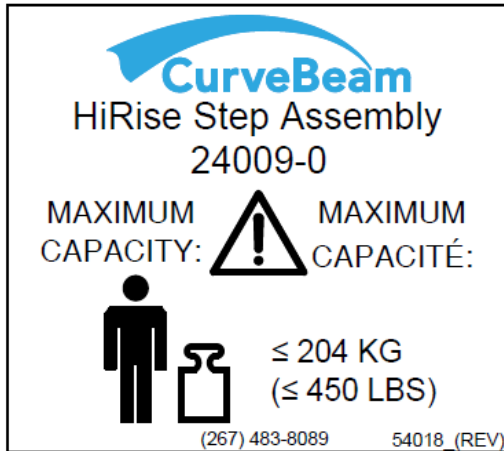

Knee Plate Label:



Single Foot Platform Label:

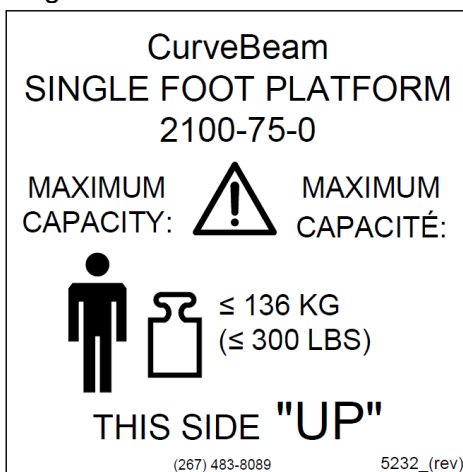

Hand Platform Label:



Upper Extremity Shield Label:



Non-Weight Bearing Platform Label (for using the Patient Chair):



Guide Rail Label for the Patient Chair:

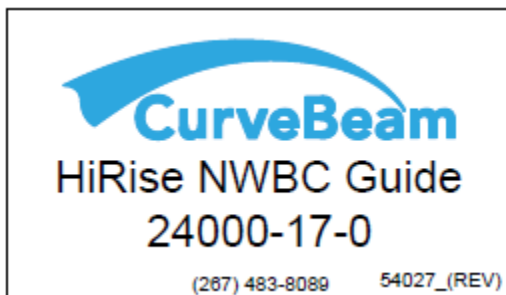

Gantry Shield (No-flex) Label:

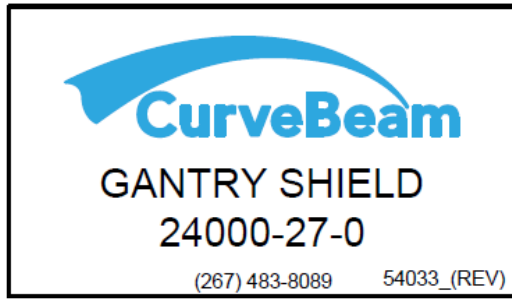

Flex Shield Label (top and bottom):

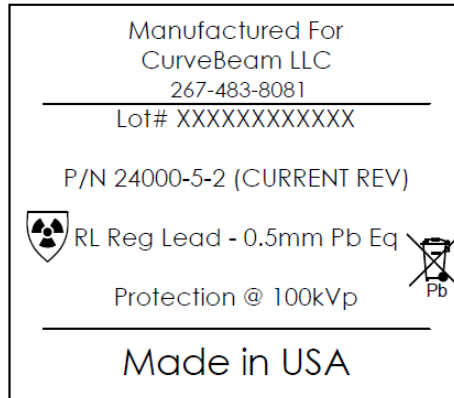
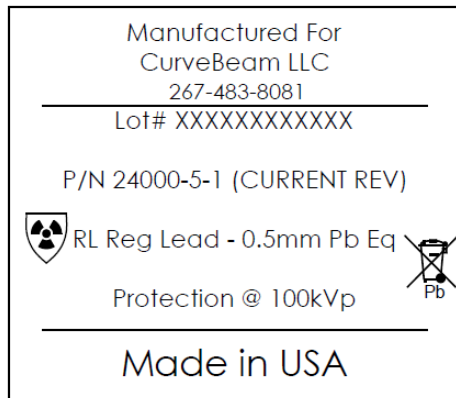

Patient Chair label:

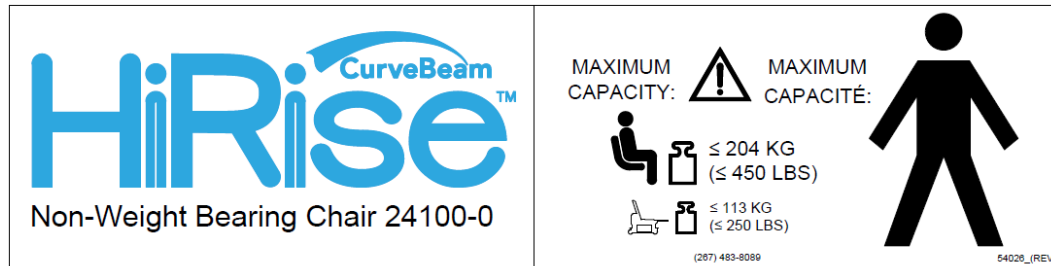

Non-Weight Bearing Chair label (for foot section):



Up/Down Movement Labels for Foot Pedals on Chair:

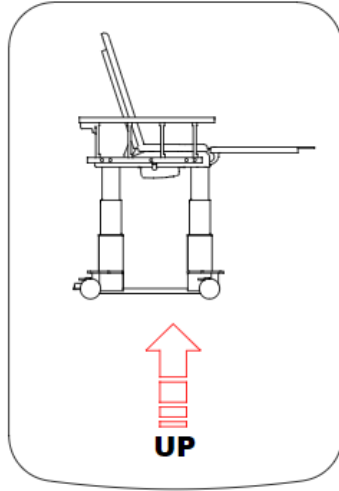
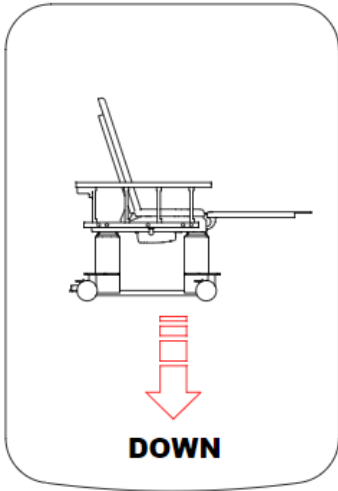

Accessory Rack Label:



Quality Assurance Phantom Label:



Center Locator Calibration Tool Label:









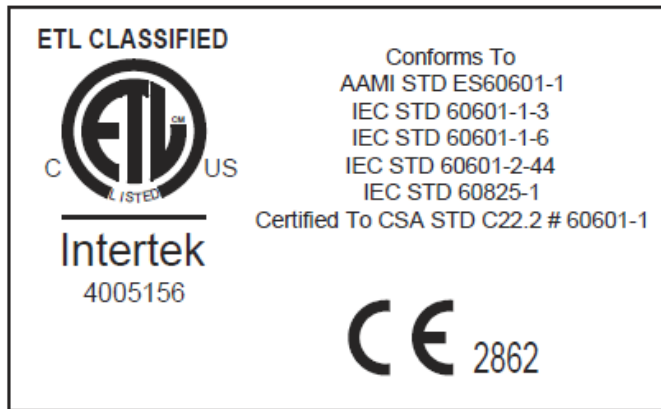





















Geometric Calibration Tool Label:



ETL Overlay Label:



SYMBOLS:			
 General Warning	 Ionizing Radiation	 Electrical Hazard	 AC In
 Emergency Stop	 X-Ray Radiation	 Non-Ionizing Radiation	 Network Cable
 Power	 Follow Operating Instructions for use.	 Type B (body) applied part complies with IEC 60601-1	 Control Box
 Ready	 Scan	 Recycle	 Pinch Point
 X-Ray On	 Interlock	 Output for Interlock 5VDC 30mA	 Maximum weight capacity for sitting.
 Fault	 Pinch Point - Feet	 Maximum Weight capacity for standing.	 Maximum weight capacity for handlebars.
 Laser			
 Fuse 1A 250VAC, Thermal, Push to Reset 250mA 250VAC, Thermal, Push to Reset	 Power/Circuit ON  Power/Circuit OFF	 CE Mark class IIb	This product carries the CE Mark. The CE Declaration (CE Conformity) becomes invalid if the product is changed without explicit consent of the manufacturer! This applies to all parts, not only to safety elements.

European Authorized Representative:	Emmanuel Alcover EA-Services 16 Rue des Sallières 31210 Montréjeau
-------------------------------------	---

System Controls and Indicators

Operator Control Box:

The Operator Control Box contains the status indicator lights as well as the Emergency Stop button and the Exposure Control Switch. This can sit on a table or be mounted on a wall. It is equipped with a 50 foot cable.

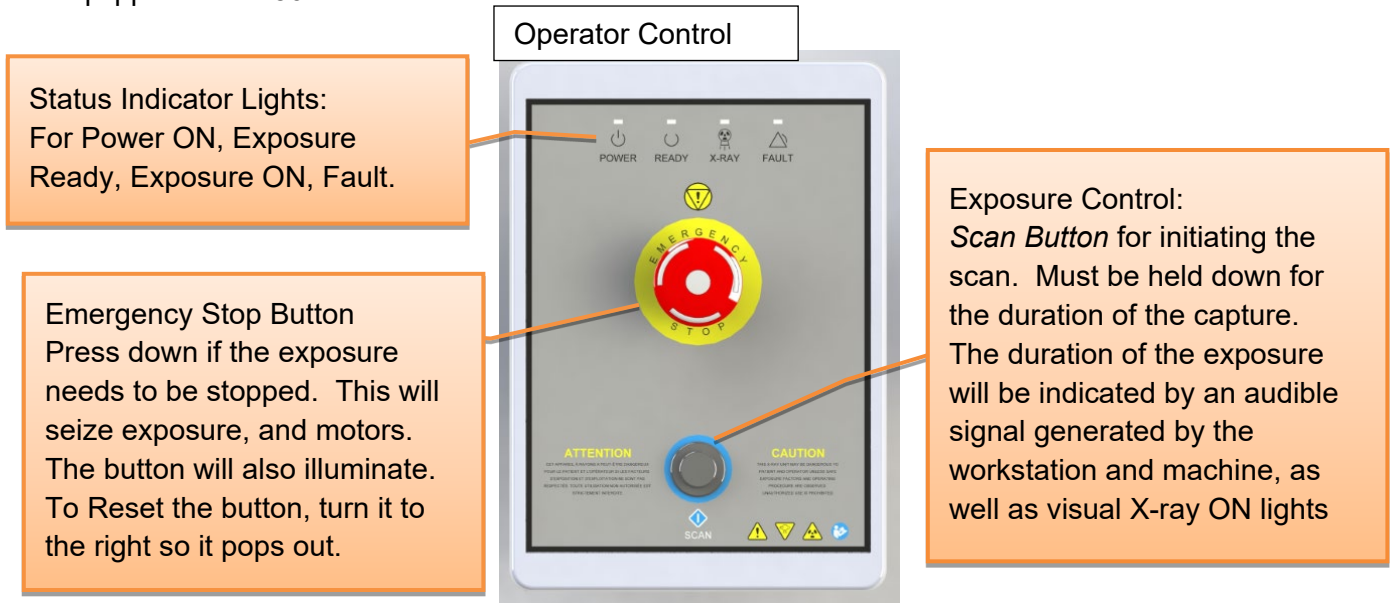





Patient Emergency Stop Button:

This Emergency stop button is intended for the patient to stop exposure during a scan. This will seize exposure and stop all motion. It is located on the machine itself. To Reset the button, turn it to the right so it pops out.

System Status Indicators

There are 4 indicator lights. These indicator lights are on the Operator's control box and on the machine itself on the upper right cover. There are also similar indicators within the Acquisition software program.

The lights are as follows:

-  **Power ON:** This is solid **Green** when the machine is ON.
-  **Ready:** This is the Exposure Ready light and is **Green** when the machine is in Ready state for exposing. This would indicate that it is time to press the exposure button.
-  **X-Ray ON:** This is an **Amber** color when the system is exposing, emitting X-ray.
-  **Fault:** This would be **Red** in color if there was a failure in the system.

Status Indicator panel on machine: *front right and left cover*

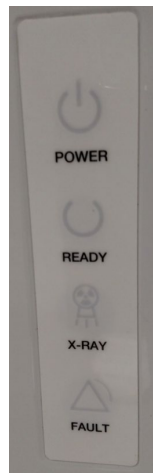

CHAPTER 4: Calibration and Quality Assurance (QA) Procedures

Calibration Procedures

Calibrations are necessary for proper performance of the HiRise. A Panel Calibration needs to be performed by a CurveBeam Technical Support specialist annually. The user can request a calibration at the scheduled interval by contacting CurveBeam Technical Support to assist with the calibration.

 **WARNING** Prior to performing any calibrations, ensure the machine is not in use, and patient is not in the scanner.

Quality Assurance Procedures

The Quality Assurance (QA) procedures are designed to check for Image Quality, Accuracy of Distance Measurements, Consistency, and Uniformity. These procedures can be performed by a HiRise owner/operator, or any service technician or radiation physicists. It is recommended that this QA procedure be performed quarterly or if there are any indications of image quality or accuracy issues.

The Quality Assurance Procedures are comprised of the following:

- Image Quality Assessment, which includes:
 - High Contrast Spatial Resolution (Line Pair measurement)
 - Hounsfield Units accuracy of 5 density chambers
- Distance Measurement Accuracy
- Consistency and Uniformity, which includes:
 - Noise Level Test
 - Uniformity Test

The QA Procedures will be performed by scanning the Unified QA phantom provided by CurveBeam. This Unified QA Phantom is comprised of QA Line Pair/Materials section and a simulated water section. Image Data will be captured and assessed for acceptable values.

The Unified QA Phantom is shown, positioned in the scanner, here:

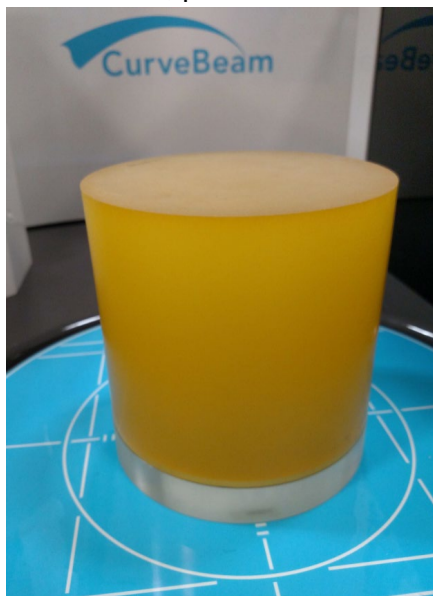

- **WARNING** Prior to performing any quality assurance procedures, ensure the machine is not in use, and patient is not in the scanner.

To perform the Quality Assurance Procedures Automatically, the operator can open the CurveBeam ToolShed application on the Acquisition. The ToolShed application will allow the operator to acquire the Unified QA phantom and will automatically detect and measure the Image Quality, Accuracy of Distance Measurements, Consistency, and Uniformity. The results will be displayed to the operator after a successful calibration and will be stored for future review. Follow the steps below for each protocol as required. CurveBeam recommends

performing a DC120(MFOV) and a DB120(LFOV) to correctly assess the full status of the device.

1. Navigate to the Acquisition Station.
2. Open the application labeled Toolshed.
3. Initialize the machine by holding the motion button as prompted.
4. Go to the Target Calibrations Tab, Choose the Protocol you would like to run .

CurveBeam AI Toolshed
File View Help

Run All Calibrations Targeted Calibrations Calibration Detail

QACAL_AUTOQA3D

Code	Last Attempt Status	Last Successful Attempt	FO
X-CBCT_UC_100	PASSED	PASSED 2023-03-21 17:56:04	FOV_UC
X-CBCT_UC_120	UNCALIBRATED	PASSED 2023-03-21 16:55:26	FOV_UC
X-CBCT_UA_100	PASSED	PASSED 2023-03-22 11:16:45	FOV_UA
X-CBCT_UA_120	PASSED	PASSED 2023-03-21 17:08:21	FOV_UA
X-CBCT_UA_130_1_25	UNCALIBRATED	PASSED 2023-03-22 09:42:40	FOV_UA
X-CBCT_UA_130_1_35	UNCALIBRATED	PASSED 2023-03-22 09:31:32	FOV_UA
X-CBCT_UA_130_7	UNCALIBRATED	PASSED 2023-03-22 09:49:25	FOV_UA
X-CBCT_DC_100	PASSED	PASSED 2023-03-21 17:44:16	FOV_DC
X-CBCT_DC_120	UNCALIBRATED	PASSED 2023-03-21 17:16:54	FOV_DC
X-CBCT_DB_100	PASSED	PASSED 2023-03-22 11:07:09	FOV_DB
X-CBCT_DB_120	UNCALIBRATED	PASSED 2023-03-21 17:23:56	FOV_DB
X-CBCT_DB_130_1_25	UNCALIBRATED	PASSED 2023-03-22 09:59:44	FOV_DB
X-CBCT_DB_130_1_35	UNCALIBRATED	PASSED 2023-03-22 10:24:00	FOV_DB
X-CBCT_DB_130_7	PASSED	PASSED 2023-03-22 11:00:19	FOV_DB

5. Go back to the Run All Calibrations Tab and click Start.
6. Follow the On Screen Instructions for positioning the phantom and performing the scan.

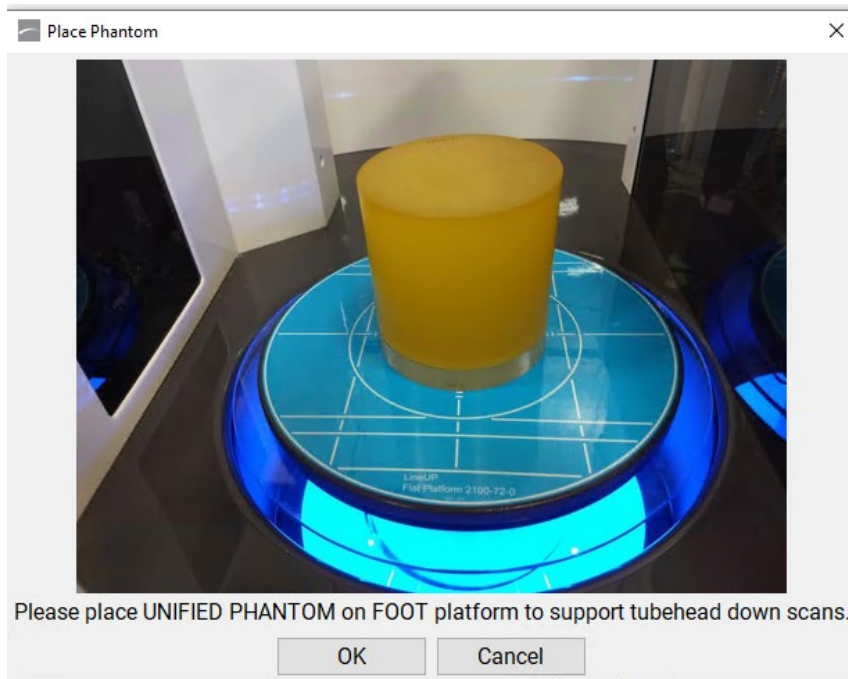

- After the scan is complete review the results on the results tab. ** If any calibrations do not pass please contact technical support.

Run All Calibrations Targeted Calibrations Calibration Detail

AutoQA3D Output Details

Results for Volume Series UID:
2.16.840.114490.1.3.1999165168.3268.1680622316.140

Series Description
OACAL_AUTOQA3D-X-CBCT_DC_120

Machine Serial Number/Institution Name
4003/CurveBeam Customer

Acquisition Date and Time
2023-04-04 11:27:00

OVERALL RESULT **PASS**
(All HU measurements are in Hounsfield units)

	Center	2σClk	5σClk	8σClk	11σClk
Water HU	79	29	33	29	29
Water SD	59	54	55	59	59
Water Uniformity	PASS		Water Noise (HU)	PASS 109.0 HU	

WATER RESULT **PASS**

	Air	Teflon	Urethane	LDPE	Acrylic	Nylon
Materials HU	972	925	26	141	29	29
Materials SD	11	23	24	21	22	21
CNR	3.81					
Linepairs(lp/cm)	12					
Phantom Diameter(mm)	150.5					
MATERIAL RESULT	PASS					

QA3D Material Slice

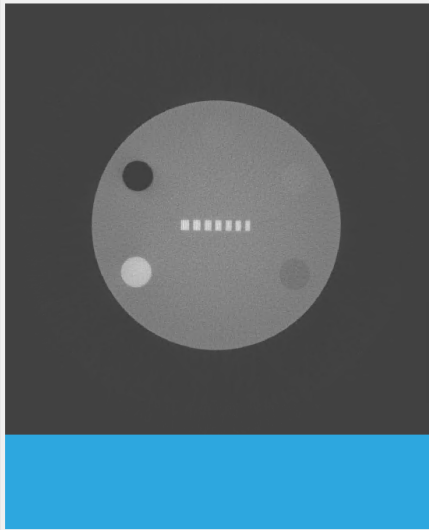

Fit Fill 1:1 Zoom In Zoom Out First / Last

QA3D Water Slice

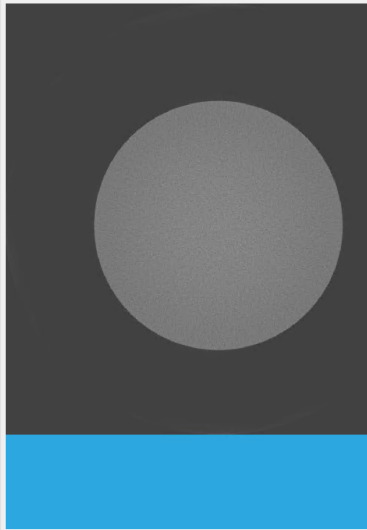

Fit Fill 1:1 Zoom In

Calibration Complete

- You can review previous results by clicking the Review QA results button on the Run All Calibrations Tab.

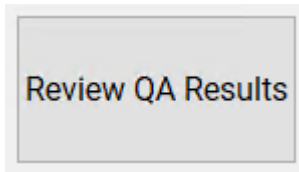

To perform the Quality Assurance Procedures Manually, the following steps will need to be performed twice. The first time on a Medium Field of View (MFOV) scan and the second on a Large Field of View (LFOV) scan. The scans to be performed are specified in the instructions which follow. All steps are identical for MFOV and LFOV scans, except for the High Contrast Spatial Resolution (Line Pairs) expected from MFOV and LFOV scans. The difference is noted in the instructions as the appropriate step.

1. Place the Unified QA Phantom on the patient platform in the center of the device, using the circular positioning guides to center it on the platform. The line pair section should form a long horizontal line that goes from left to right. The simulated water should go on top of the line pair section. Simulated water is removed in the image below to show alignment and positioning.

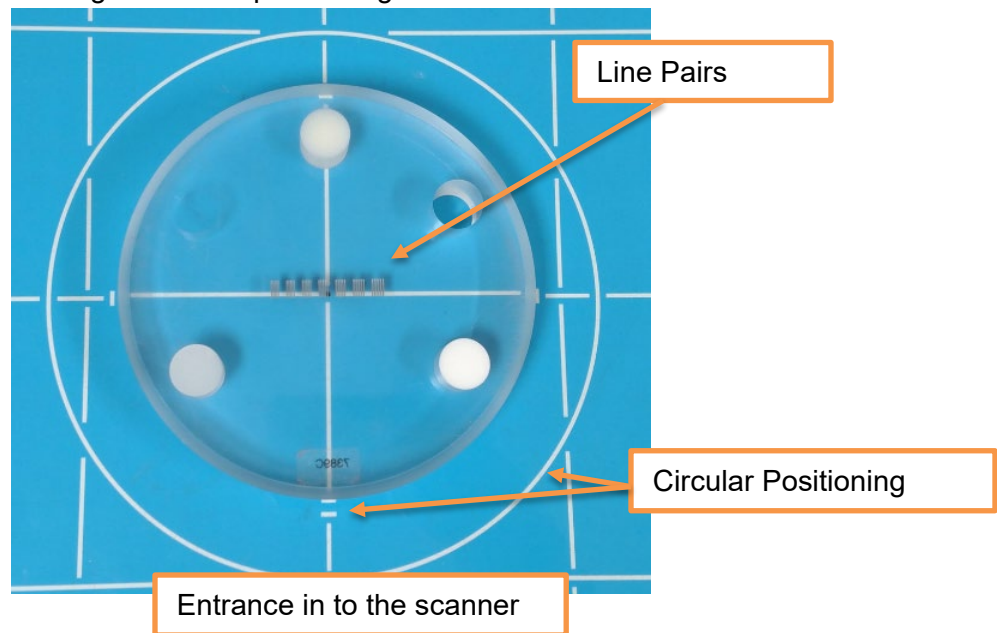

Ensure that the entire Unified QA Phantom, both the QA Line Pair/Materials section and a simulated water section, is placed on the patient platform as show below:

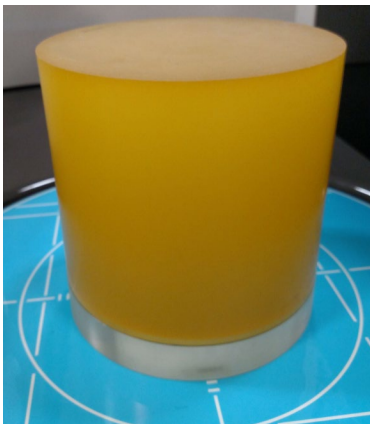

2. Acquire a CBCT scan of the phantom using a **Medium Field (120 kVp) Foot scan**.



Advice: Please refer to the Acquiring a Scan section of the manual, Chapter 6, for Acquiring the scan).



WARNING The X-ray device may be dangerous to the Patient and Operator if you do not observe and follow operating instructions. Do not operate this system unless you have received training to perform a procedure

3. Open the newly captured scan in CubeVue, or another DICOM Viewing software, and load the acquired scan to perform all of the QA Procedures.
4. Apply the Sharp Filter on the image in the DICOM viewing software– keep this set for all of the remaining QA procedures.
5. Change the slab thickness to the smallest thickness in the axial window – keep this set for all the remaining QA procedures.
6. Evaluate High Contrast Spatial Resolution (Line Pairs):
 - a. Center the Line Pairs in the axial window. This can be done by using the coronal and sagittal views to approximate the center of the line pairs (height), then view in the axial window.
 - b. Observing the line pairs in the DICOM Viewer's axial view, determine how many line pairs can be seen accurately, where lines can be distinguished as lines. The line pairs start at 10 line pairs (easiest to distinguish these line pairs), the second set of line pairs is 11 line pairs per cm, third set is 12 line pairs per cm, and so forth. The expected result should be 11 line pairs per cm or better.
 - c. Visually verify that there is definition present for each of the lines in line pair 11, or higher, for a MFOV scan. For a LFOV scan, 10 line pairs per cm, or higher, should be visible.

7. Evaluate Hounsfield (HU) Accuracy of Density Chambers (HU of 5 Materials & Background Material):
 - a. Remain on the same Axial slice as in the last step where the Line Pairs are visible. If using CubeVue, in the Measurement section, select HU and then “QA unified” to provide six small HU circles. The positioning of the HU circles may not be exact and they may require slight adjustment to align them over the 5 materials, plus the background material. If using another DICOM viewer, select HU circles that are within the materials, with an approximate area of 141mm². The image below shows the QA unified circles from CubeVue placed over the 5 materials and the background material.

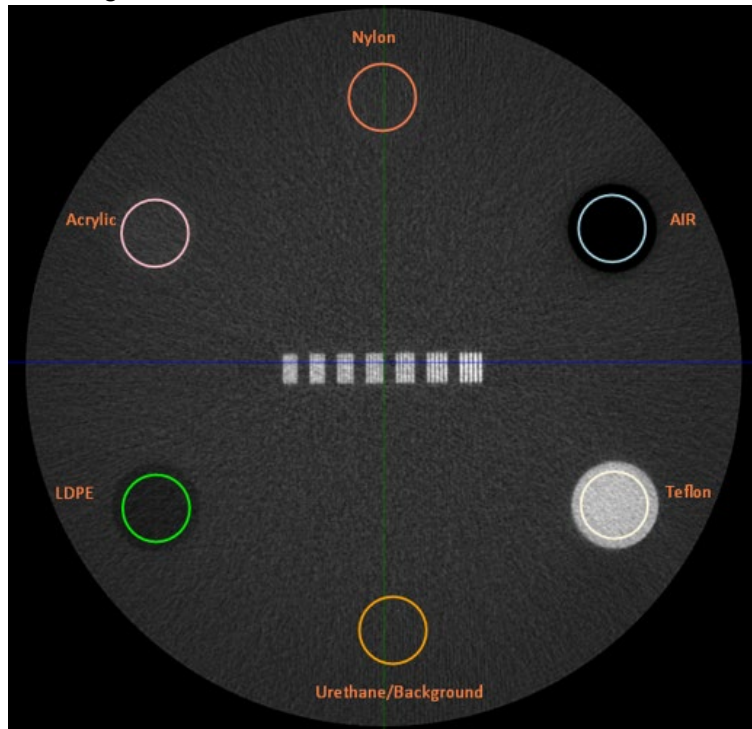

- b. Measure the Hounsfield Units value of each density chamber.

 Advice: Keep the HU circle off the borders of the chambers.

The results should fall within the below ranges.

 Advice: Nylon can be difficult to see, it is positioned between the Acrylic and Air chambers. The values in the table do go in order (either clockwise or counterclockwise) around the materials. If the value is not in range, check to ensure the correct material is selected.

Density Material	Expected HU value Ranges
AIR (black chamber):	-1150 to -850
TEFLON (white chamber):	700 to 1200
Background Material :	-100 to 200
LDPE (dark gray chamber):	-300 to -0
ACRYLIC (light gray chamber):	-25 to 275
NYLON (lightest gray chamber):	-50 to 250

8. Evaluate Distance Measurement Accuracy (diameter measure of phantom):
 - a. Remain on the same Axial slice as in the last step where the Line Pairs are visible. Make a distance measurement of the diameter of the Unified QA Phantom, using the Distance Tool, from one edge of the phantom to the other edge. It is best to go through the center of the line pair, to ensure a true diameter measure. The diameter of the Unified QA Phantom should be between 148.5 – 151.25 mm for MFOV and 148.5 – 151.5 for LFOV.

9. Noise Level Test (HU water, center):
 - a. In the currently open Unified QA Phantom scan, navigate to the center of simulated water in either the Coronal or Sagittal View. Then view the center slice in the Axial View.
 - b. If using CubeVue, in the Measurement section, select HU and then “QA set large” to provide large HU circles, which can be moved to the desired location. CubeVue will provide 5 HU circles, the center circle is used for this test, the other circles will be used in the next QA procedure. If using another DICOM viewer, select HU circles that create an area of about 600mm² to measure the HU value. And place the HU circle in the center of the simulated water.
 - c. The mean measurement value, at the center of the simulated water, should be in the range of:
Water: +/- 150 HU

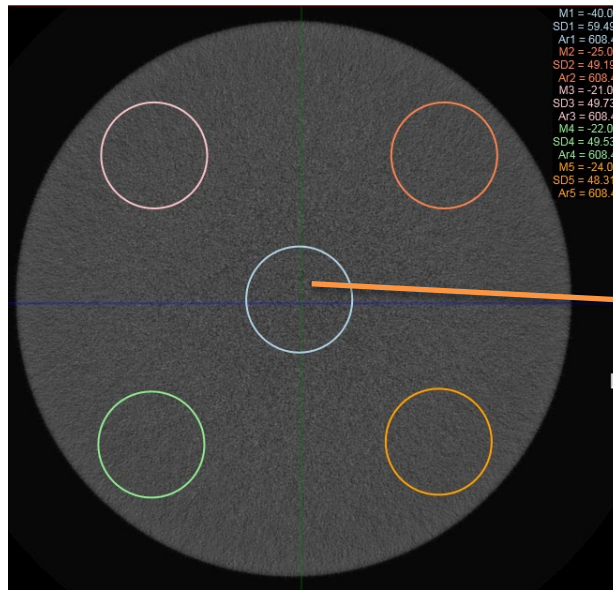

In CubeVue HU QA set large selected. Note the blue center circle and corresponding blue mean value (M1 in this example)

10. Uniformity Test (HU water 4 quadrants):

- a. Still on the same Axial slice, in the center of the simulated water, if not using CubeVue, make 4 additional HU circles of similar size to the one made for the center circle (approximate area of 600mm²). If using CubeVue, all circles are already available.
- b. Ensure that the center HU circle is still in the center, and then move the other 4 HU circles so that one is in each quadrant, near the edge, but not too close, as shown below:

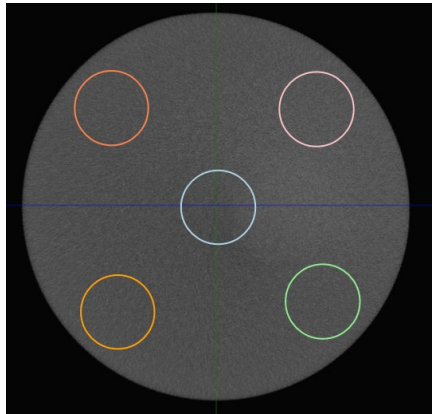

- c. Compare the mean HU value (provided by HU tool) of each of the 4 quadrants with the center mean HU value. The mean HU of each of the 4 circles should be within 250HU of the mean HU value measured from the center circle.

11. Repeat Steps 1-10 using a Large Field (120kVp) Foot Scan.

Radiation Output Test

It is recommended that a check of the kVp(eff) and Radiation Output of the X-ray source be performed annually by a qualified Physicist. The incident Absorbed Dose at the detector may be measured using a dosimeter. Tests are performed to assess output value and to check for tube output consistency and timer accuracy.

 **WARNING** Prior to performing any radiation output testing, ensure the machine is not in use, and patient is not in the scanner.

1. Attach a dosimeter to the detector such that the sensor is positioned where the vertical and lower horizontal laser lights intersect.
2. Perform a Standard scan of 40 cm diameter x 30 cm height, 0.3 voxel (Procedure Name: Medium Field (120kVp)) and record the time and dose from the meter.

 **WARNING** The X-ray device may be dangerous to the Patient and Operator if you do not observe and follow operating instructions. Do not operate this system unless you have received training to perform a procedure

3. Perform a Standard scan of 40 cm diameter x 30 cm height, 0.3 voxel (Procedure Name: Medium Field (100kVp)) and record the time and dose from the meter.

 **WARNING** The X-ray device may be dangerous to the Patient and Operator if you do not observe and follow operating instructions. Do not operate this system unless you have received training to perform a procedure

CHAPTER 5: Radiation Environment Survey

Scatter Measurements

Methodology

The Scatter measurements were taken using a RadCal 10X60-180 Leakage and low measurements Ion Chamber (serial: 08-0455) last calibrated 09/11/2020. Each measurement was made using a single rotation scan in the lower position using 130 kVp at 6.5 mA with 720 projections and 35 ms pulse width. This type of scan is considered the highest output the scanner can produce.

The Ion Chamber was placed at different heights along the Z axis and different positions along the X and Y axis while the scan was run. A CTDI PMMA 32 cm phantom was placed in the FOV during each scan. The measurements are recorded in the table below.

Y axis = 0.0 m		Left to Right (x direction) in uR						
		-1.5m	-1.0m	-0.5m	0.0m	0.5m	1.0m	1.5m
	2.0m	359.90	552.10	827.43	856.59	811.38	630.85	493.48
Z-Axis	1.5m	166.39	926.59	1415.40	924.55	1492.11	902.96	138.62
	1.0m	155.45	496.11	2490.73	3155.71	2555.77	507.48	198.06
	0.5m	84.38	194.10	5838.93	14110.27	5871.02	233.79	91.70
	0.0m	61.51	59.73	NA	NA	NA	60.52	45.59
	-0.5m	87.90	247.50	2355.70	6270.58	2084.75	263.25	77.78
	-1.0m	117.07	308.86	1828.68	2064.33	2076.58	316.15	96.80
X-Axis = 0.0m		Front to Back(y direction) in uR						
		-1.5m	-1.0m	-0.5m	0.0m	0.5m	1.0m	1.5m
	2.0m	389.36	581.27	825.09	856.59	822.18	634.64	470.44
Z-Axis	1.5m	424.07	1482.19	1645.52	1152.91	1398.49	899.17	657.68
	1.0m	402.19	2304.07	3216.95	3155.71	3041.96	1058.42	416.77
	0.5m	121.82	1455.36	5707.69	13235.30	6328.91	291.95	109.75
	0.0m	131.89	277.07	NA	NA	NA	258.09	124.68
	-0.5m	277.92	633.47	2643.85	6270.58	365.74	378.57	147.90
	-1.0m	284.95	839.21	3281.12	2064.33	182.46	208.18	127.98
Y axis = 0.0 m		Left to right (x direction) in uR						
		-1.5m	-1.0m	-0.5m	0.0m	0.5m	1.0m	1.5m
	2.0m	192.81	295.78	443.28	458.91	434.69	337.97	264.38
Z-Axis	1.5m	89.14	496.41	758.28	495.31	799.38	483.75	74.27
	1.0m	83.28	265.78	11.79	1690.63	1369.22	271.88	106.11
	0.5m	45.20	103.98	3128.13	7559.38	3145.31	125.25	49.13
	0.0m	32.95	32.00	NA	NA	NA	32.42	24.42
	-0.5m	47.09	132.59	1262.03	3359.38	1116.88	141.03	41.67
	-1.0m	62.72	165.47	979.69	1105.94	1112.50	169.38	51.86
X-Axis = 0.0m		front to back(y direction) in uR						
		-1.5m	-1.0m	-0.5m	0.0m	0.5m	1.0m	1.5m
	2.0m	208.59	311.41	442.03	458.91	440.47	340.00	252.03
Z-Axis	1.5m	227.19	794.06	881.56	617.66	749.22	481.72	352.34
	1.0m	215.47	1234.38	1723.44	1690.63	1629.69	567.03	223.28
	0.5m	65.27	779.69	3057.81	7090.63	3390.63	156.41	58.80
	0.0m	70.66	148.44	NA	NA	NA	138.27	66.80
	-0.5m	148.89	339.38	1416.41	3359.38	195.94	202.81	79.23
	-1.0m	152.66	449.69	1757.81	1105.94	97.75	111.53	68.56

All Measurements in uGy/mAs								
Y axis = 0.0 m		Left to Right (x direction) in uR						
		-1.5m	-1.0m	-0.5m	0.0m	0.5m	1.0m	1.5m
	2.0m	0.00015805	0.00055243	0.00061330	0.00042970	0.00052123	0.00033513	0.00024513
Z-Axis	1.5m	0.00014990	0.00085875	0.00119899	0.00117617	0.00113377	0.00039448	0.00015534
	1.0m	0.00004541	0.00054243	0.00212732	0.00493294	0.00235886	0.00010881	0.00004090
	0.5m	0.00004916	0.00010327	#VALUE!	#VALUE!	#VALUE!	0.00009619	0.00004647
	0.0m	0.00010358	0.00023610	0.00098539	0.00233712	0.00013631	0.00014110	0.00005512
	-0.5m	0.00010620	0.00031278	0.00122291	0.00076940	0.00006800	0.00007759	0.00004770
	-1.0m	0.00000000	0.00000000	0.00000000	0.00000000	0.00000000	0.00000000	0.00000000
X-Axis = 0.0m		Front to Back(y direction) in uR						
		-1.5m	-1.0m	-0.5m	0.0m	0.5m	1.0m	1.5m
	2.0m	0.00015805	0.00055243	0.00061330	0.00042970	0.00052123	0.00033513	0.00024513
Z-Axis	1.5m	0.00014990	0.00085875	0.00119899	0.00117617	0.00113377	0.00039448	0.00015534
	1.0m	0.00004541	0.00054243	0.00212732	0.00493294	0.00235886	0.00010881	0.00004090
	0.5m	0.00004916	0.00010327	#VALUE!	#VALUE!	#VALUE!	0.00009619	0.00004647
	0.0m	0.00010358	0.00023610	0.00098539	0.00233712	0.00013631	0.00014110	0.00005512
	-0.5m	0.00010620	0.00031278	0.00122291	0.00076940	0.00006800	0.00007759	0.00004770
	-1.0m	0.00000000	0.00000000	0.00000000	0.00000000	0.00000000	0.00000000	0.00000000

All Measurements in uGy/mAs								
Y axis = 0.0 m		Left to right (x direction)						
		-1.5m	-1.0m	-0.5m	0.0m	0.5m	1.0m	1.5m
	2.0m	0.0220	0.0337	0.0505	0.0523	0.0495	0.0385	0.0301
Z-Axis	1.5m	0.0102	0.0566	0.0864	0.0564	0.0911	0.0551	0.0085
	1.0m	0.0095	0.0303	0.0013	0.1927	0.1560	0.0310	0.0121
	0.5m	0.0052	0.0119	0.3565	0.8615	0.3584	0.0143	0.0056
	0.0m	0.0038	0.0036	N/A	N/A	N/A	0.0037	0.0028
	-0.5m	0.0054	0.0151	0.1438	0.3828	0.1273	0.0161	0.0047
	-1.0m	0.0071	0.0189	0.1116	0.1260	0.1268	0.0193	0.0059
X-Axis = 0.0m		front to back(y direction)						
		-1.5m	-1.0m	-0.5m	0.0m	0.5m	1.0m	1.5m
	2.0m	0.0238	0.0355	0.0504	0.0523	0.0502	0.0387	0.0287
Z-Axis	1.5m	0.0259	0.0905	0.1005	0.0704	0.0854	0.0549	0.0402
	1.0m	0.0246	0.1407	0.1964	0.1927	0.1857	0.0646	0.0254
	0.5m	0.0074	0.0889	0.3485	0.8080	0.3864	0.0178	0.0067
	0.0m	0.0081	0.0169	N/A	N/A	N/A	0.0158	0.0076
	-0.5m	0.0170	0.0387	0.1614	0.3828	0.0223	0.0231	0.0090
	-1.0m	0.0174	0.0512	0.2003	0.1260	0.0111	0.0127	0.0078

CTDI Measurements

CTDIVol Methodology

CTDIVol measurements were made using the Rad Cal 10x6-3ct CTDI 100 mm pencil ion chamber (serial: 05-1454) last calibrated 03/24/2020. Measurements were taken using the CTDI PMMA 16cm or 32 cm Phantom depending on the intended use of the scan type. Scans were completed using a single rotation of the device. Separate measurements were taken with the pencil ion chamber in the center of the phantom and the 4 outside positions while keeping the phantom in the center of the scanners FOV. The CTDIVol was then calculated using the formula ($1/3 \times \text{center measurement} + 2/3 \times \text{average of four quadrants}$). CTDIVol was calculated for DC-100KVP, UC-120KVP, DB- 120KVP and UA-130KVP and the results are displayed in the table below.

Phantom	DC, 100kvp, 5.5ma, 12ms, 720 frames, Mode 7	UC, 120kvp, 5.5ma, 12ms, 480 frames, Mode7	DB, 100kvp, 5.5ma, 12ms, 720 frames, Mode 7	DB, 120kvp, 5.5ma, 12ms, 720 frames, Mode 7	UA, 130kvp, 6.5ma, 35ms, 720 frames, Mode 1
16 cm 0°	2.265	2.588			0
16 cm 90°	2.281	2.606			0
16 cm 180°	2.268	2.584			0
16 cm 270°	2.26	2.594			0
16 cm Center	1.966	2.277			0
32 cm 0°			1.266	2.345	7.784
32 cm 90°			1.278	2.379	7.5586
32 cm 180°			1.284	2.333	7.518
32 cm 270°			1.276	2.347	7.6902
32 cm Center			0.6165	1.149	3.9578
CTDI Vol (mgy)	2.167666667	2.487666667	1.056166667	1.950333333	6.411066667
DAP (dgy*cm2)	11.58	14.03	11.1	19.64	78.512

-90 degrees peripheral is the max dose position.

-The Maximum Deviation from the values of CTDI measurements given will be no more than +/- 1 mgy

CTDI Air Methodology

CTDI Air Measurements were taken at Iso Center using a Rad Cal 10x6-3ct CTDI 100 mm pencil ion chamber (serial: 05-1454) last calibrated 03/24/2020. Each measurement was made using a single rotation scan in the foot position. Each measurement was taken 10 times and the results averaged. Four different sets of measurement were completed to cover the standard output of the device. The results are displayed in the charts below.

Measureme	DB - KVP 100(mg)	DC - KVP 100(mgy)	UC - KVP 120(mgy)	DB - KVP 120(mgy)	UA - KVP 130(mg)
Scan 1	2.334	2.335	2.77	3.926	4.732
Scan 2	2.337	2.346	2.769	3.927	4.741
Scan 3	2.343	2.351	2.77	3.941	4.751
Scan 4	2.344	2.355	2.771	3.945	4.756
Scan 5	2.345	2.357	2.775	3.955	4.761
Scan 6	2.348	2.363	2.773	3.96	4.763
Scan 7	2.348	2.364	2.777	3.966	4.77
Scan 8	2.353	2.368	2.739	3.974	4.773
Scan 9	2.355	2.368	2.732	3.978	4.782
Scan 10	2.36	2.369	2.727	3.985	4.784
Average	2.3467	2.3576	2.7603	3.9557	4.7613
Normalized	0.59324519	0.495158885	0.69780317	1	1.203655484

*The Maximum Deviation from the values of CTDI measurements given will be no more than +/- 1 mg

Dose Profile

Methodology

The dose profile was measured using two stacked CTDI body phantoms in order to have the beam entirely in a phantom. An ion chamber (Rad Cal 10x6-3ct SN 05-1454 last calibrated 03/24/2020) was moved through the phantom and the dose was measured at different points. These were plotted with the position. This was done for both the x-ray tube up and x-ray tube down positions.

Results

The dose profiles are shown in the plots below.

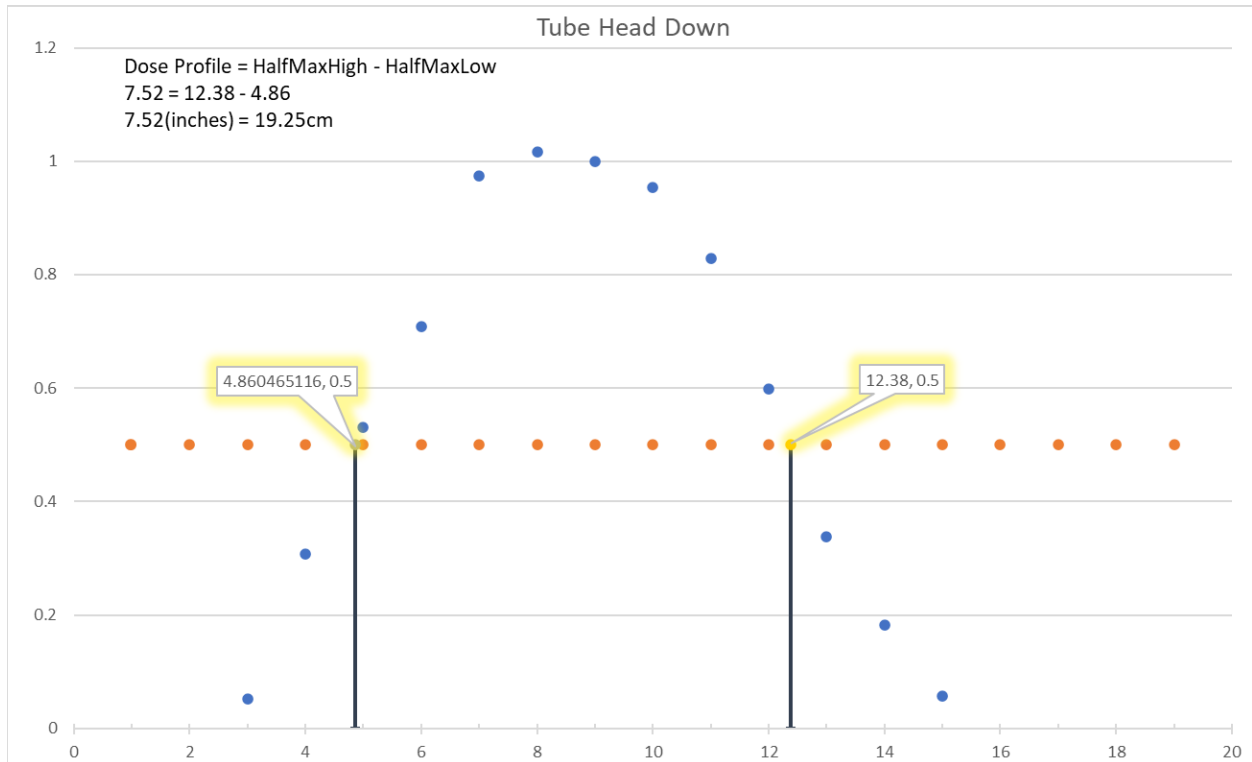

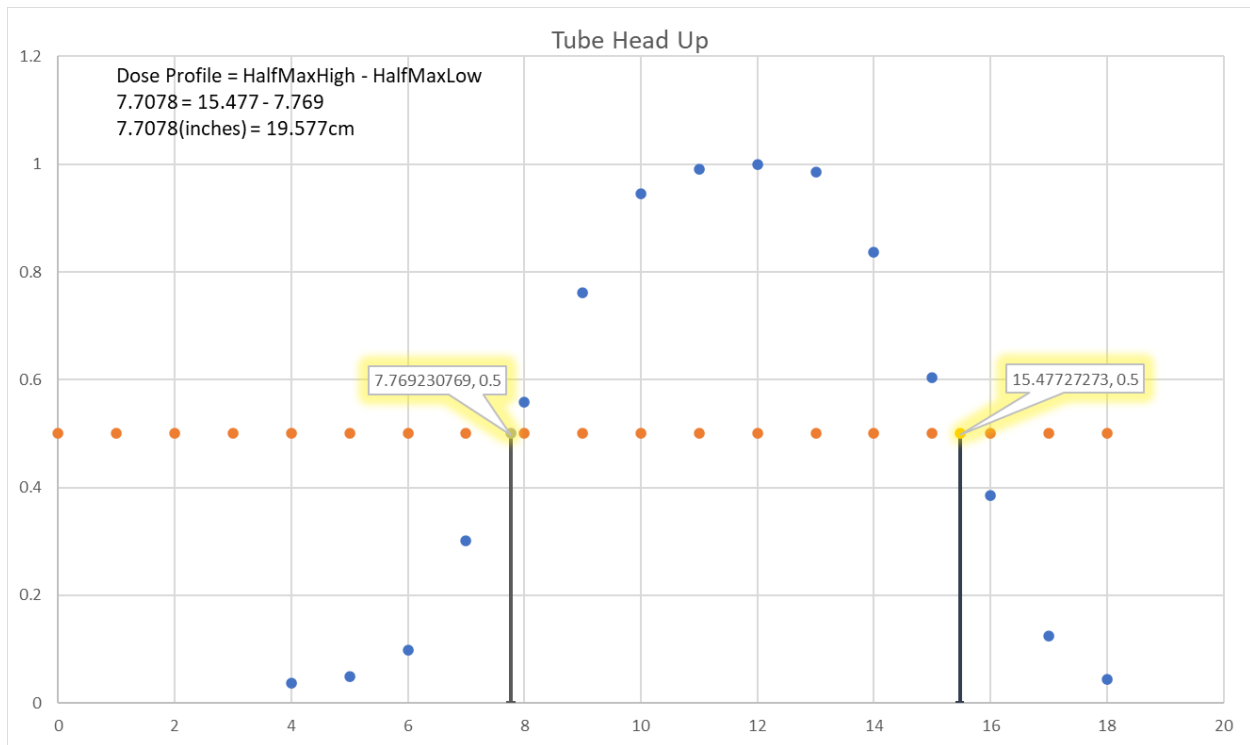

	HiRise X-Ray Tube Head Up	HiRise X-Ray Tube Head Down
Full Width Half Maximum (cm)	19.57	19.25
Imaged Area (cm)	19.56	19.56

Modulation Transfer Function (MTF)

Methodology

Using the manufacturer's Quality Control Phantom, a series of high contrast line pairs were scanned. The profile of each line pair group was plotted, the average peak pixel value and the average low pixel value were compared to the pixel value of the bar material and the background. As the spatial frequency increases the amplitude of the signal (peak to trough pixel values) drops, relative to the bar material and background, yielding the MTF. The MTFs for each scan type are plotted and shown with the 0.10 MTF being reported in the table in Mm. This approach is in alignment with the approach proposed in GJB 5312-2004. The 120 kVp technique was used in the x-ray tube head up position and 100 kVp was used in the x-ray tube head down positions.

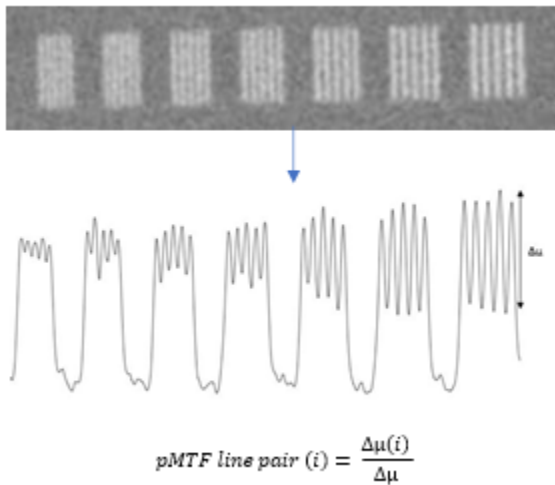

Results

X-ray tube head down:

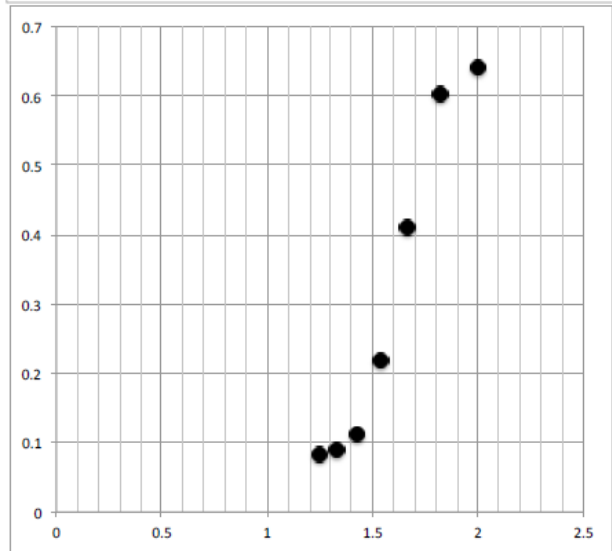
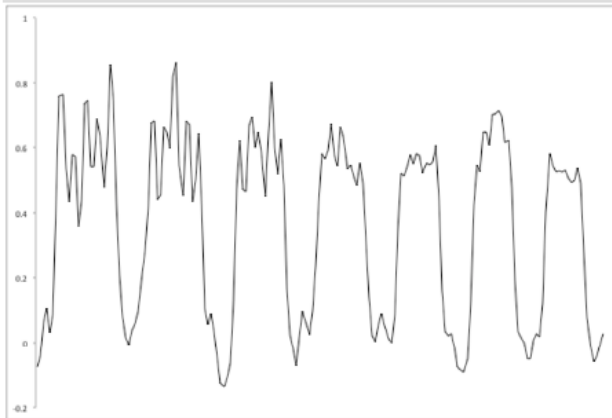

Limiting Resolution (MTF < 0.1)	
Line Pair per mm (lp/cm)	15
mm	1.33

Uniformity

Methodology

Uniformity was determined in the water-equivalent phantom. One center region of interest (ROI) is compared to 4 peripheral ROIs. Limits are determined by the manufacturer.

Results

X-ray tube head down, LFOV, 130kVp

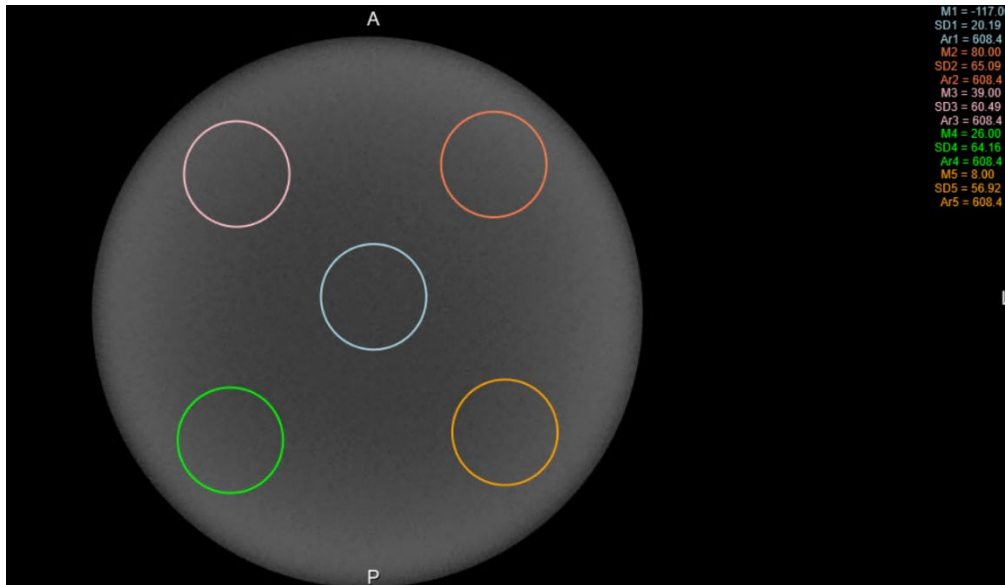

Protocol	Worst Case	Pass/Fail – Limit < 100
Tube Down/LFOV, 130KVP	44.9	Pass

CT Number Accuracy

Methodology

CT number accuracy was tested for this unit using the manufacturer's quality control phantom, which includes cylinders of 4 different materials – Teflon, acrylic, air, and low density polyethylene. LDPE. Small ROIs were used to measure the CT numbers in these test materials. These values were then compared to the expected values.

Results



Material	Measured Value	Expected Value
Air	-997	-1150 to -580
Teflon	959	700 to 1200
LDPE	-52	-300 to 0
Acrylic	143	-25 to 275
Water	-51	-150 to 150

Tomographic Slice Accuracy

Methodology

Slice thickness accuracy was tested using the resolution test pattern in the QC phantom. The thickness of this test pattern is 0.08" (2.032 mm) according to the phantom's manufacturer. The CT number of the test pattern was evaluated at a number of slices, and the full-width at half maximum (FWHM) was evaluated. The expected slice thickness is 0.3 mm.

Results

As shown in the plot below, the FWHM was determined to be 6.576 pixels. 6.576 pixels would need to be 0.31 mm thick to result in the correct pattern thickness. This is well within the range of 0.2 – 0.4 mm.



Exposure-mAs Linearity

Methodology

The mA/mAs linearity test assesses the unit's linearity over the range of these parameters available on the generator and using all available focal spot sizes. Measurements are performed at a fixed kVp setting and an mR/mAs value is calculated for each exposure. No two adjacent mR/mAs values may differ by more than 0.1 times their sum. The estimated coefficient of variation of the measured output should be no greater than 0.05. This system was tested at 60 kVp.

Results

mAs	Focal Spot Size	Nominal mAs	Displayed Exposure Time (msec)	Measured Exposure Time (msec)	Measured Exposure (mR)	mR/mAs
6.5	Large	6.5	1300.0	1299	2.379	0.37
6	Large	6.0	1200.0	1199	2.204	0.37
5	Large	5.0	1000.0	999.0	1.853	0.37
4	Large	4.0	800.0	799.2	1.398	0.35
3.75	Large	3.8	750.0	749.3	1.375	0.37
3	Large	3.0	600.0	599.0	1.103	0.37
2.5	Large	2.5	500.0	499.2	0.875	0.35
2	Large	2.0	400.0	399.1	0.741	0.37
1.5	Large	1.5	300.0	299.3	0.548	0.37
0.75	Large	0.8	150.0	149.6	0.271	0.36

Coefficient of Variation	0.021
--------------------------	-------

Timer Accuracy

Methodology

The accuracy of the unit's timer circuit is determined by taking a number of exposures at different timer settings and comparing actual versus indicated exposure lengths. In general, specifications for timer accuracy are set by the equipment manufacturer, but in no case should the percent difference between indicated and actual time be greater than 10% (or 1 pulse for single-phase units, whichever is greater).

Results

Indicated Time (msec)	Measured Time (msec)	Difference (msec)	Percent Difference
1300.0	1299.0	1.0	0.1%
1200.0	1199.0	1.0	0.1%
1000.0	999.0	1.0	0.1%
800.0	799.2	0.8	0.1%
750.0	749.3	0.7	0.1%
600.0	599.0	1.0	0.2%
500.0	499.2	0.8	0.2%
400.0	399.1	0.9	0.2%
300.0	299.3	0.7	0.2%
150.0	149.6	0.4	0.3%

*CTDI, DAP and other measurements are within the tolerance of +/- 5%.

Half Value Layer Results

Half Value layer test were run for the high, mid and low value outputs of the device. Each dose measurement was made using a Radcal Rapidose Sensor, RAPD-W. After each dose was measured a known thickness of aluminum was placed in the XRay output. The dose was then measured again, and the value recorded. When the dose measured was half the original dose the thickness of the aluminum was recorded, and the test was completed. The recorded doses are below.

Half Value Layer Test	100kv 5.5ma
Initial Dose uGy 55frames	205.5
Half Value uGy (205.5 / 2)	102.75
6.25mm	122.2
7.8mm	108.8
8.3mm	104
8.6mm	100.9
8.45mm	102.7uGy

Half Value Layer Test	120kv 5.5ma
Initial Dose uGy 55frames	337.9
Half Value uGy (337.9 / 2)	168.95
12.50mm	137.7
9.3mm	171.6
9.4mm	169.7uGy

Half Value Layer Test	130kv 6.5ma
Initial Dose uGy 55frames	419.2
Half Value uGy (419.2 / 2)	209.6
11.8mm	181.7
9.8mm	208.5uGy

Z-axis point spread function

The HiRise has a fixed and rigid patient positioning platform that does not incorporate any table motion or indexing (no “table pitch”). The detector panel has a square shape, while the pixels on the panels are square shaped as well. The raw projections are acquired in a single 360-degree orbit, thus covering the entire Field of View (FOV) height in one rotation. This results in isotropic voxels in the reconstructed volume, hence the same spatial resolution in the z-axis as in the x-y plane. Due to this projection geometry, calculation of a separate z-axis point spread function should not be applicable.

Recommended Operating Requirements

Local agencies or government bodies or international standards may dictate requirements for installation of the system in order to protect personnel and the public from exposure from the radiological output of the device. Consult your local agencies, government bodies, or international standards for actual requirements which apply.

It is recommended that a qualified Physicist or Radiologist determine where appropriate, the applicable lead shielding to be installed in the area around the system equipment. Below are some other common requirements that may apply to your location:

- The Operations computer (server) and X-ray Operator should be located behind a properly shielded permanent barrier. A viewing window should be present to enable the X-ray Operator to view the Patient and operate the computer while the exposure is present.
- Operators should consider the use of a lead apron to protect the anatomical areas of the medical personnel working in the areas exposed to radiation.
- The Operator Control Box and Acquisition Computer shall be located within 1 meter [3.28 ft] from a door. If not, an interlocked door may be required.
- A room door may be required.
- Radiation warning signs may be required next to the entrance to the room.
- A Warning light may be required by the entrance to the room.
- A shielding plan should be performed where the system is being installed. Some local agencies or government bodies require that a shielding plan be conducted by a qualified Physicist or Radiologist and a copy of the shielding plan be submitted and approved prior to installation of the system.
- An area radiation survey by a qualified physicist or Radiologist may then be required within 30 days of initial clinical use of the system. This survey may be required to be submitted to the local agency or government body

Site Survey

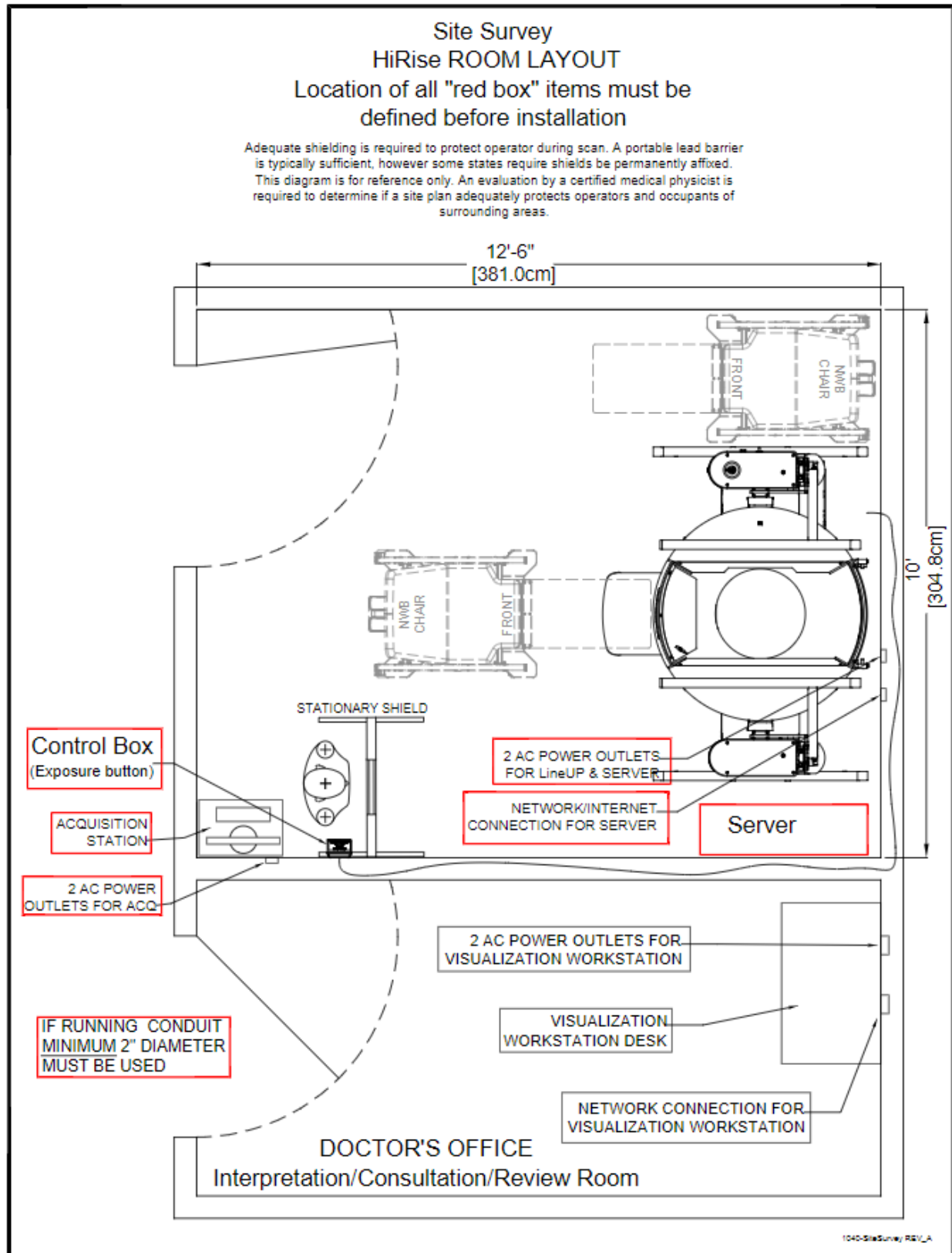

X-ray Tube Assembly

CurveBeam utilizes an X-ray Tube, model SXR 130-15-0.5SC, from Superior X-ray Tube Co, 1220 Claussen Drive, Woodstock, IL 60098. Below are the X-ray Tube Specifications:

Superior x-ray Data Sheet for the SXR 130-15-0.5SC:

The SXR 130-15-0.5SC insert is a stationary anode, glass envelope x-ray tube. The SXR 130-15-0.5SC is an x-ray tube designed to be used in dental panoramic and Cone Beam Computerized Tomography (CBCT) applications. Currently, other applications include medical, security, and industrial imaging applications. The insert should be housed in a unit that allows for insulating media such as high dielectric mineral oil (Diala-AX) or high dielectric pressurized gas such as SF6 (Sulfur Hexafluoride).

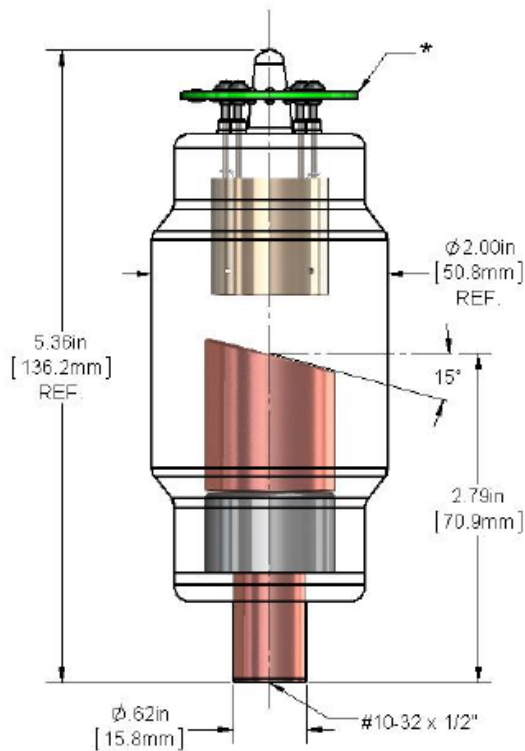

SXR 130-15-0.5SC

Physical Characteristics:

Glass Frame:	Borosilicate 0.085" thick
Inherent Filtration:	1.1 mm Al equivalent at 80 kV
Focal Spot:	0.5 mm Nominal
Target Angle:	15°
Target Material:	Tungsten (W)
Filament Material:	Tungsten (W)
Focus Cup Material:	Nickel (Ni)
Anode Body:	Copper (Cu)

Thermal Characteristics:

Anode Heat Storage Capacity:	45 KHU's (31KJ)
Max. Anode Heat Dissipation Rate:	23.4 KHU's/min.

Electrical Characteristics:

Max. Tube Potential:	130 kV
Filament V-A Curve:	See Chart
Max. Single Exposure:	See Chart

NOTE: * Please contact Superior Engineering Department for cathode terminations options.

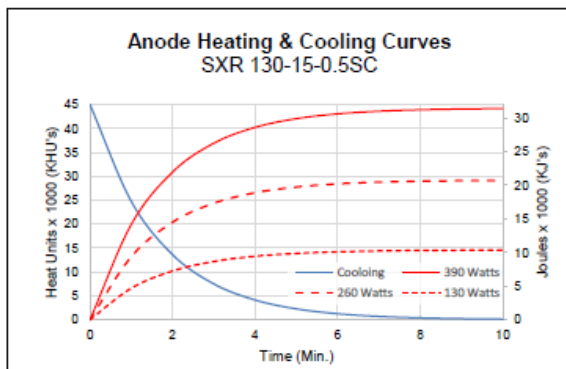
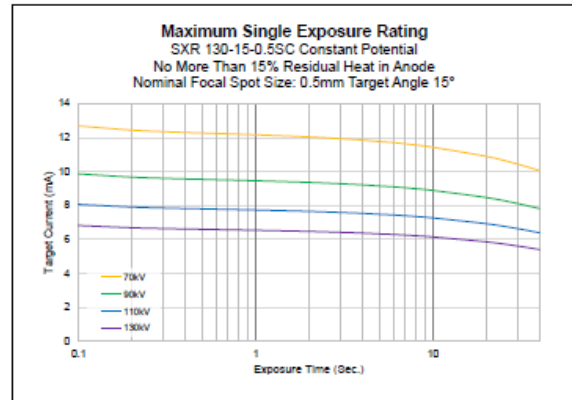
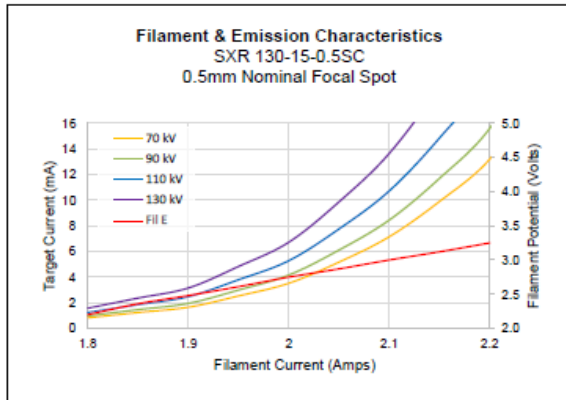

Notes:

1. The ratings, from the factory, are based on the insert being immersed in a large tank (50 Gal.) of high dielectric, high grade insulating oil. Data should be validated in the customers designed, production based, tube housing to determine the factor limiting heating i.e. tube head, insert anode.
2. The dielectric value of the oil should not fall below 40,000 volts peak per 0.1 inch.
3. Oil should be processed via heat and vacuum to drive out any moisture and outgas air.
4. The tube envelope must be thoroughly cleaned prior to putting the tube in operation. Particular attention should be given to remove all fingerprints resulting from handling the tube. A clean dry, lint-free cloth and alcohol are recommended for cleaning.
5. The oil in the housing, surrounding the tube, should never be allowed to exceed 158°F (70°C).
6. It is recommended that a resistor of at least 130,000 ohms be placed in series with the x-ray tube in the high voltage circuit.
7. Great care should be taken to minimize any forces being applied to the cathode pins to prevent failure of the glass seal.
8. Heat Units equals $(HU=kV \cdot mAs)$.

Beam Path and Angulation

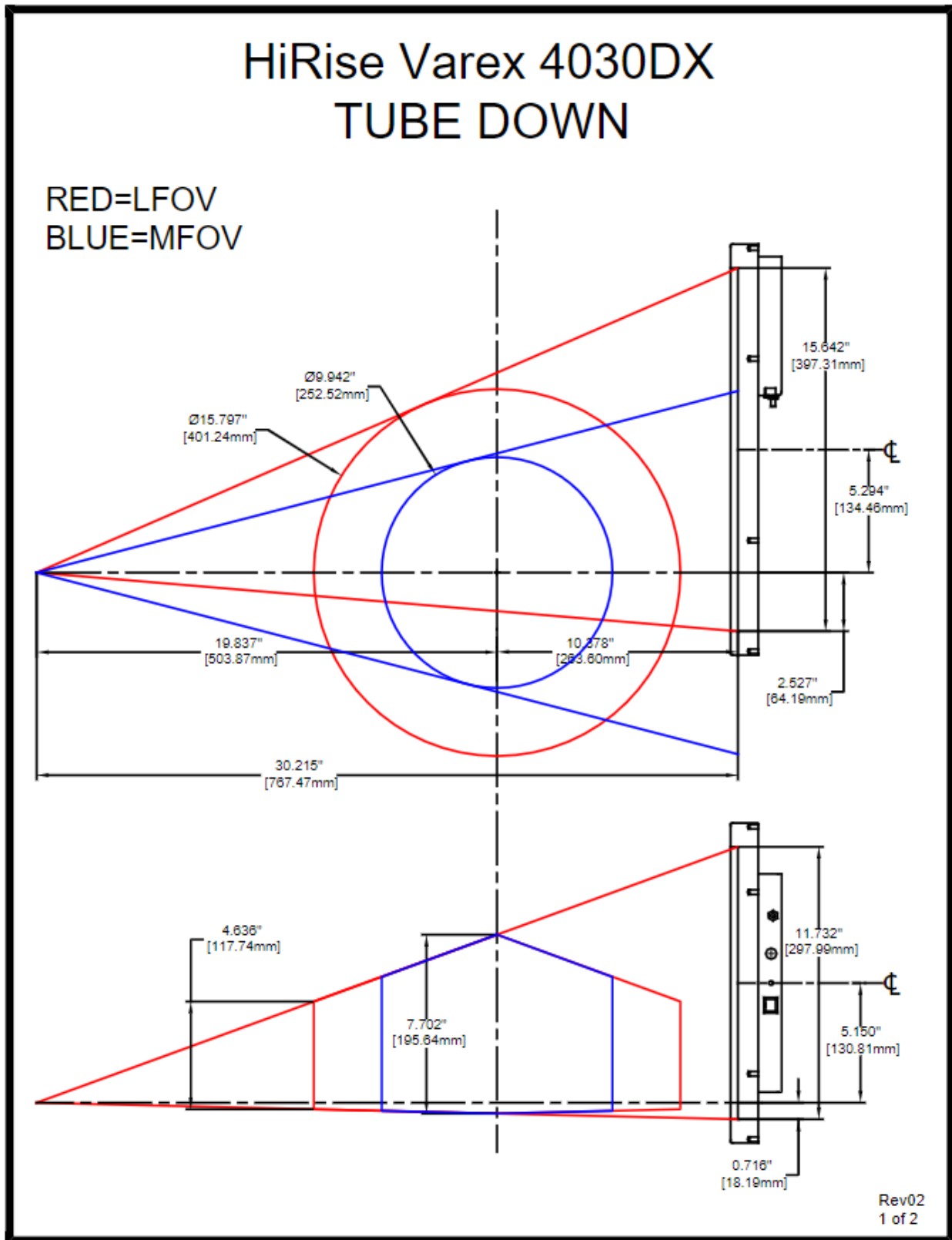

HiRise FOV Varex 4030DX TUBE UP

RED=LFOV
BLUE=MFOV

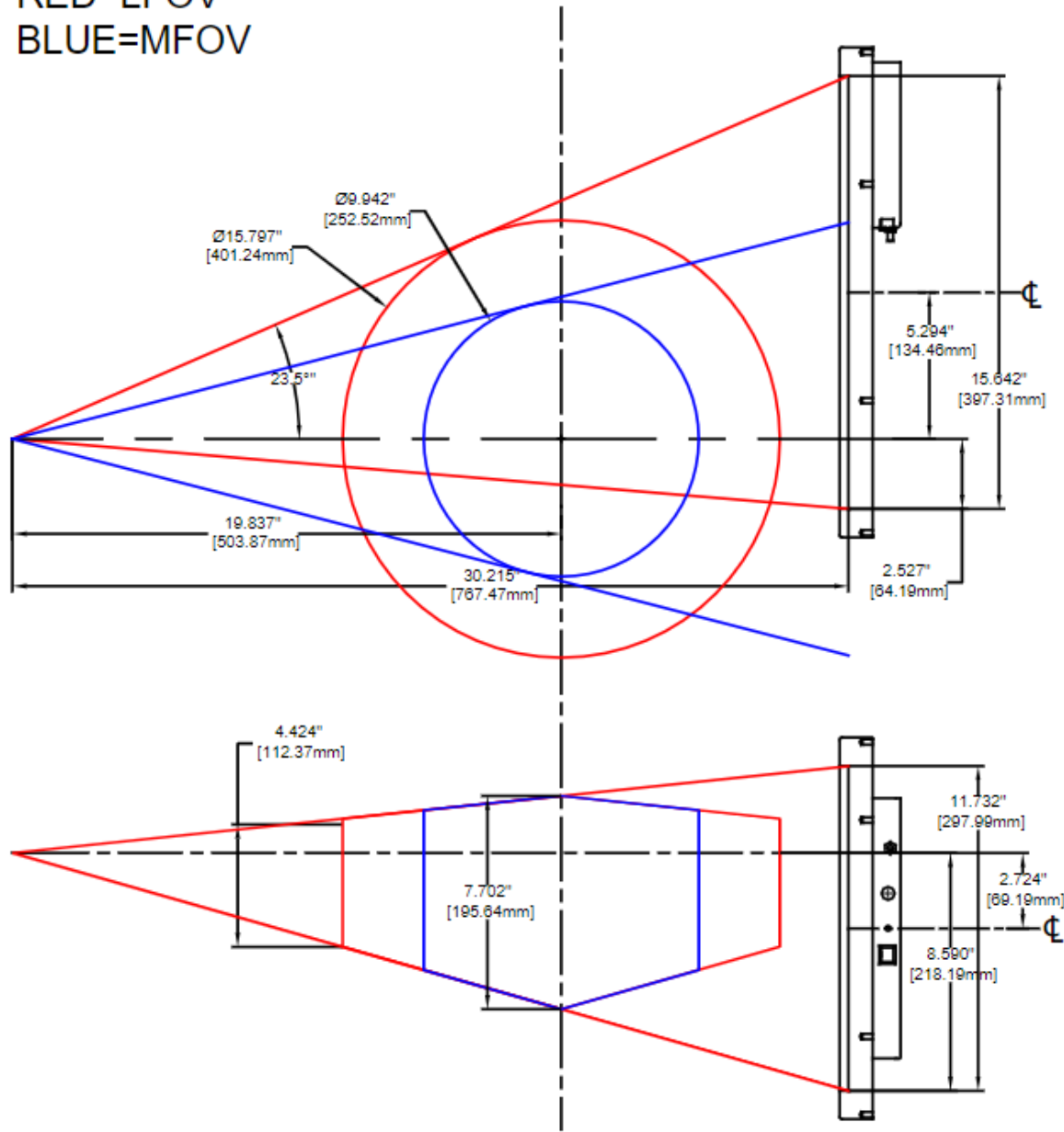

Rev02
2 of 2

Geometric Efficiency

The geometric efficiency was calculated in the Z direction. 100% of the image is being utilized to construct the image in both collimation settings.

Geometric Efficiency Table		
	Total Collimation Width	Z-Axis Geometric efficiency (%)
MFOV	42mm	100
LFOV	42mm	100

CHAPTER 6: Operations - Acquiring a Scan

System Startup

The HiRise system at a minimum includes the Scanning device, the computer server, and an Operator's control Terminal. All must be powered **ON** in order for the system to operate properly.

The Scanning device circuit breaker should always be set to the ON position. This is located on the lower left side of the machine. This is the machine ON/OFF control. The vertical line (|) is the ON position. The circle (0) is the OFF position.

Power ON is indicated on both the Machine Status Indicator panel and the Operators control box Status indicator panel lights. Power ON is lit in **Green**. **The machine must be ON for 30 seconds before the Acquisition Software should be launched. Optimal Scanning results will be achieved with the machine warmed up for 2 hours.**

Start up the Acquisition software by double clicking on the CB-Scanner Shortcut.

When using the Acquisition software, if an error occurs, the software should be closed and restarted. If cycling power on the Acquisition software does not clear the error, please contact CurveBeam Technical support at the number listed on the cover of the manual.

Visually inspect the device before use for any damage to the covers that expose internal components.

HiRise Acquisition Software Interface

The HiRise Acquisition Software, "CB Scanning Device" Interface consists of the below sections, each with its own tab near the top of the screen:

- Patient: Access or Add New patient information and intended procedure.
- Protocol: The user will set up scan parameters, such as scan protocol.
- Scan: Perform the Scan Acquisition.
- Quality: Perform a QA (Quality Assurance) check of the scan acquired.

To view the software version that is being run, click on Help, then About.

PATIENT Tab: Accessing/Entering Patient Information & Selecting Scan Procedure

Patient Demographic Information can be either imported into the system via a Worklist or can be Added as a “New Patient” via the HiRise ACQ software Patient Tab when “Add Patient” is selected. The Patient Screen will appear as shown below:

Patient Name	Patient ID	Accession	Birth Date	Scan Date	Procedure
Jones, Jacob	123-ABC	14	20001209	20180705	CT_KNEE_R
Smith, Sam	987654321	15	19900502	20180705	DX_FOOT_L

To add a procedure to the Worklist, select the “Add Patient” button at the bottom of the screen. If a procedure needs to be removed, highlight the entry in the worklist and select the “Remove Patient” button at the bottom and the procedure will be removed from the list.

When the “Add Patient” button is selected, a pop-up box will appear for patient information to be added.

On the Add Patient Procedure window, the Patient Name, Patient ID, and Procedure must be filled in or selected for a patient to be added to the worklist. Some procedure names may vary from those listed in the screen shot above. The Referring and Requesting Physician fields are drop down lists. Values can be entered in manually or selected from the drop-down lists.

Referring Physician

- Dr Martin
- Referring A
- Referring B
- Referring C

These drop-down lists can be added to with a call into CurveBeam technical support, if not done at installation.

After all of the fields are entered, select the “Add Patient” button to add the patient to the Worklist.

If a patient already exists in the Worklist and an additional Procedure is required, this can be accomplished by just clicking on the “Add Procedure for Patient” button at the bottom of the screen, as shown below:

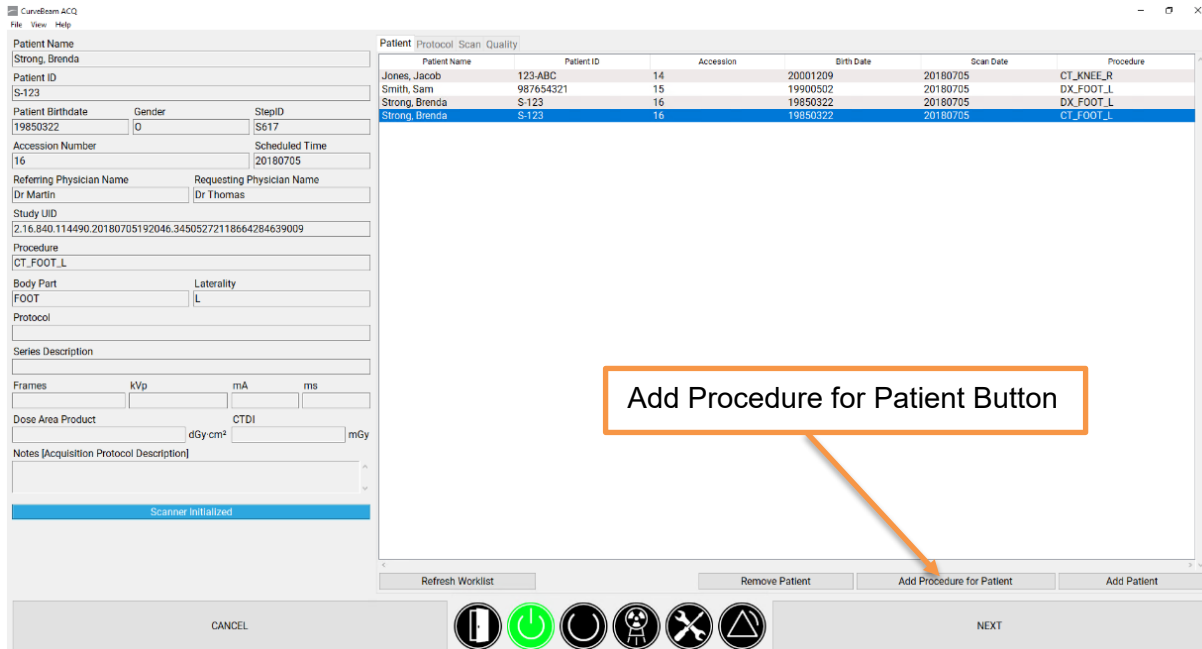

And the Add Procedure for Patient window will open, this is the same as the Add Patient window, except the values already entered for this patient are automatically filled in and grayed out, as shown below:

All that is then required is to select a Procedure for the patient, select “Add Procedure for Patient” and then the additional procedure will appear in the Worklist.

Once back on the Worklist, to select the patient for the scan, highlight the patient’s entry with the desired procedure. The patient’s information that was entered will appear on the left side of the screen.

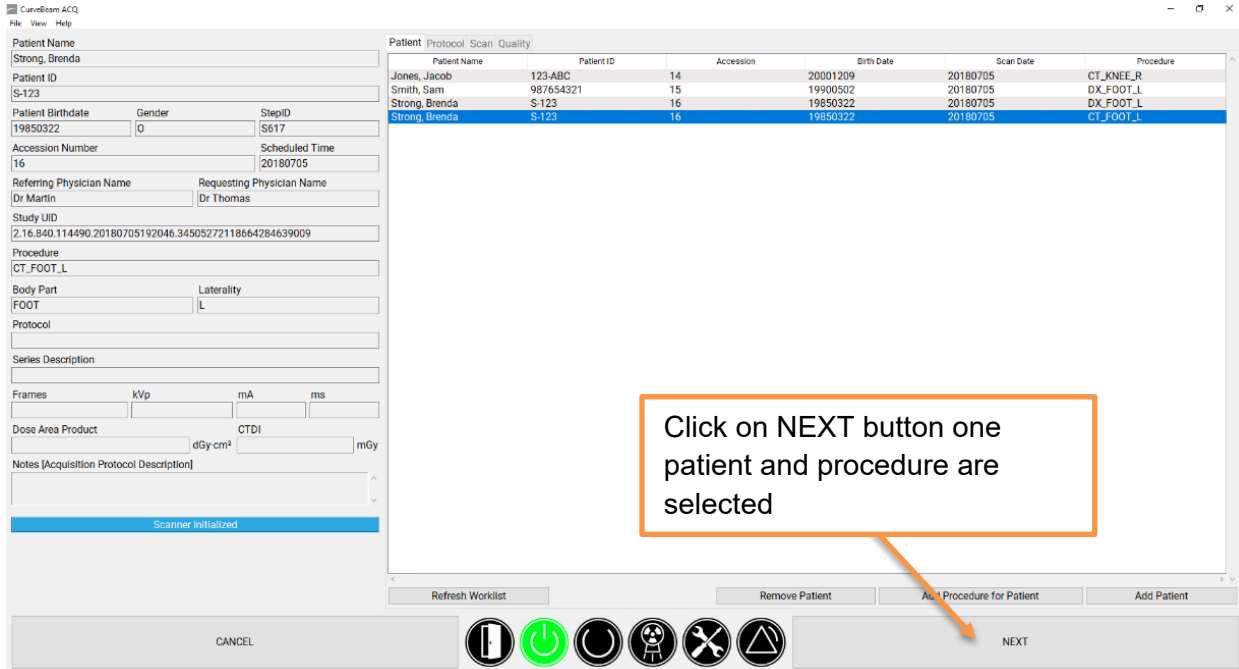

Once the patient has been selected, click on “Next” button to move to the Protocol tab. The “Next” button will remain grayed out until the patient has been selected.

PROTOCOL Tab: Selecting the Protocol

The Protocol desired is selected as well as to enable or disable the use of the Metal Artifact Reduction (MAR) option on the Protocol tab.

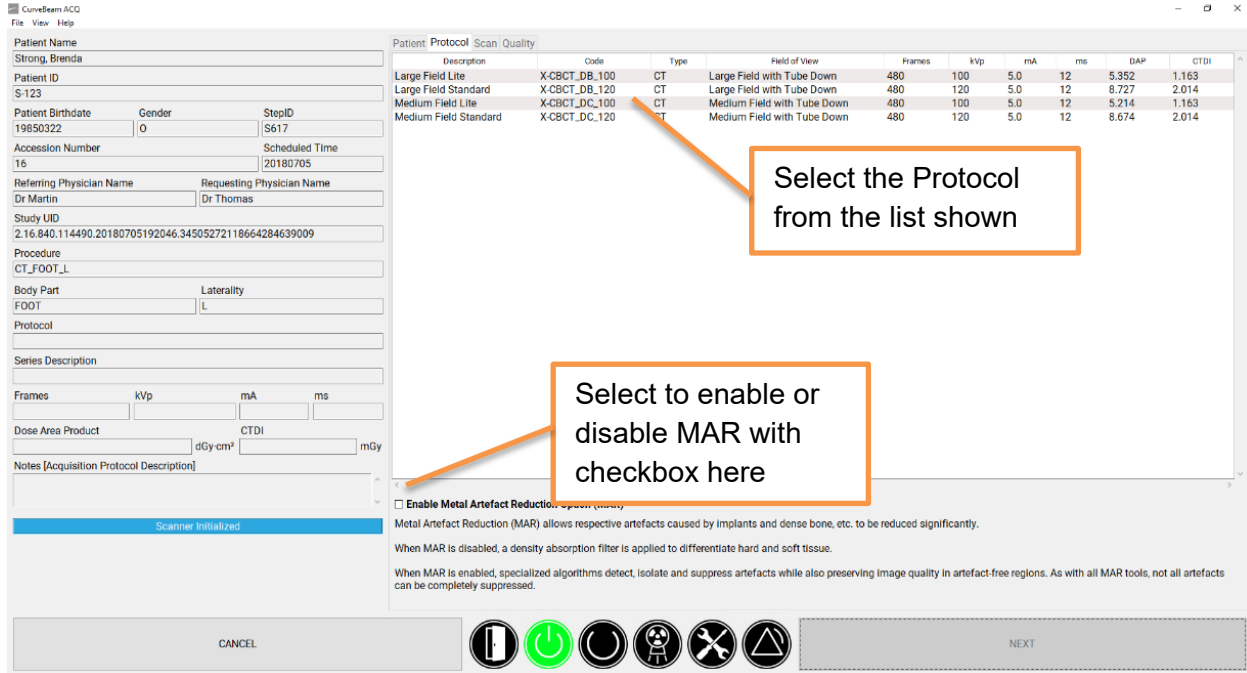

The list of Protocols that can be selected by the user differ based on the anatomy selected and the size of the patient. Once the anatomy is selected from the protocol selection, then select either a Standard dose or a Lite dose. Lite dose should be used if the patient size is small (under 100lbs). A complete list of the Protocol Codes can be found in Appendix II – Scan Protocol Technical Details.

The Protocols are a combination of one of the two tube head positions, field of view size, and the kVp. Tube head position is based on the anatomy being scanned and cannot be altered by the user once the desired anatomy to scan is selected.

RECOMMENDATIONS for Selecting a Protocol: There are 10 CT Protocols from which to select for each of the 3D procedures. Each field of view and energy output combination can be utilized in a tube up or tube down protocol. The options available will vary based on the Procedure selected and will be utilized as a Standard or Lite procedure, depending on the anatomy being imaged. The available protocol attributes are as follows:

Large Field (130kVp): (43 cm diameter x 20 cm height, 0.3 voxel):

Select this option if the patient size is normal-large (100lbs or larger), and if you need to capture the Hip/Pelvis, Femur, or both Knees

The Large Field 130kVp protocol codes are either "X-CBCT_DB_130" or "X-CBCT_UA_130"

Large Field (120kVp): (43 cm diameter x 20 cm height, 0.3 voxel):

Select this option if the patient size is normal-large (100lbs or larger), and if you need to capture the Shin, both Feet, or are utilizing the non-weight bearing chair and imaging feet.

Select this option if the patient is small size (under 100lbs.) and if you need to capture the Hip/Pelvis, Femur, both Knees, or are utilizing the non-weight bearing chair and imaging knees.

The Large Field 120kVp protocol codes are either "X-CBCT_DB_120" or "X-CBCT_UA_120"

Medium Field (120kVp): (26 cm diameter x 20 cm height, 0.25 voxel):

Select this option if the patient size is normal-large (100lbs or larger), and if you need to capture only one Foot, Hand, Wrist, Radius/Ulna, Humerus or Elbow.

The Medium Field 120kVp protocol codes are either "X-CBCT_DC_120" or "X-CBCT_UC_120"

Large Field (100kVp): (43 cm diameter x 20 cm height, 0.3 voxel):

Select this option if the patient size is small (under 100lbs), and if you need to capture both feet, the shins, or are utilizing the non-weightbearing chair and imaging feet.

The Large Field 100kVp protocol codes are either "X-CBCT_DB_100" or "X-CBCT_UA_100"

Medium Field (100kVp): (26 cm diameter x 20 cm height, 0.25 voxel):

Select this option if the patient size is small (under 100lbs), and if you need to capture only one Foot, Hand, Wrist, Radius/Ulna, Humerus or Elbow.

The Medium Field 100kVp protocol codes are either "X-CBCT_DC_100" or "X-CBCT_UC_100"



WARNING The patient must wear a protective full wrap X-ray shielding apron (lead apron) during a scan unless the Hip or Pelvis are to be imaged. Patients less than 21 years old, small size patients (under 100 pounds) and children must also wear a gonad and ovarian front and back protective shield when appropriate for the anatomy being imaged

Also available on this tab is the MAR selection. If there is metal in the anatomy being scanned, the MAR option will help to eliminate some of the metal artifact that can be seen in a scan on a patient with metal in the field of view. **MAR reconstruction is only an estimate and the physician should use care when viewing MAR images. A careful inspection of surrounding slices should be completed for a comprehensive analysis of the resulting volume.* Selecting or deselecting this option is done on a per scan basis. If this same patient requires a second scan, the check box would revert back to the default value. To have the default value changed, please contact CurveBeam Technical Support. MAR volumes can be converted to non MAR volumes with the help of CurveBeam Technical Support without the need for a patient rescan.

Once the Protocol is highlighted, the “Next” button will become non-gray. Click “Next” when the protocol is correct for the patient being scanned to continue with the Acquisition process.

SCAN Tab: Performing the Acquisition

The Acquisition will be performed via the “Scan” Tab. The Scan Tab will display the current selected Patient Name and Procedure, as well as User Instructions and Information as to the status of what the software and scanner are doing. The Scan Tab will appear as follows:

The Series Description can be selected from the pulldown list, or typed in as desired. This field is optional. The Notes field is free form text and is also optional.

The Operator Name is a required field and must be selected. The list of operators can be configured at installation or can be modified by calling into CurveBeam Technical Support.

Instructions for how to proceed can be found in the center of the screen. Once the Operator Name has been selected, at a minimum, the Prepare Scanner for Patient will become active. Once selected, the system will make adjustments based on the selected scan. It is important to keep the scan area clear while the scanner is making these adjustments.

The HiRise uses a motion button to enable any system motion that may put the operator or patient in harm's way. When the system moves from a stationary floor position to upper extremity or non-weight bearing chair position the operator must press the motion button to enable movement. If the motion button is released, motion will stop until the operator presses the button again. **The operator should always verify that the area surrounding the system is clear of people and other items (positioners, chairs, other accessories) before pressing the motion button.**

Once the scanner has been set up, then it is time to position the patient in the scanner. Watch for the instruction to position the patient in the blue box on the left side. When instructed to position the patient, use the instructions shown in Chapter 7.

Once the patient is properly positioned close the Patient Door.

 **WARNING** Closing of the Patient Door creates a pinch point. Keep hands and feet clear when closing the Patient Door.

Next, a message will appear on screen instructing the operator to: "Press and HOLD Scan button".

 **WARNING** The X-ray device may be dangerous to the Patient and Operator if you do not observe and follow operating instructions. Do not operate this system unless you have received training to perform a procedure.

The Scan Button to start the exposure is mounted on the Operator control box.

1. Deliver the Patient Scan Instructions to the patient.

Patient Instructions for a Scan:

Once the patient is properly positioned in the system, the operator should instruct the patient to **hold perfectly still for the duration of the scan**. It is very important for the patient to hold still. If the patient moves during the volume scans, the results may not be optimal. Data is being captured when the alarm is audible (and x-ray light is ON).

2. Now Press & Hold the scan button down. During exposure an audible signal is generated by the machine, and the visual X-ray ON indicator lights will be illuminated in Amber color. The visual X-ray ON indicators are on the machine, the operator control box (above) and in HiRise Acquisition "CB Scanning Device" software. The Operator

should hold the exposure switch for the duration of the exposure as indicated by sound and lights.

3. When the audible buzzer and “X-ray on” light turn off, the x-ray is complete, however the scan button must still be held while the gantry rotates back to the starting position.

NOTE: If the exposure switch is released before the exposure time has completed, the system will STOP exposing, however the gantry and motors will complete their sequence. If the button is released prematurely, the buzzer and indicator lights will turn off and an Error message will display on screen.

Emergency Stop: In the event of an emergency during a procedure (any moving component collides with any parts of the equipment or items in the environment, or that could cause physical injury to the Patient), the Operator or Patient should utilize one of the 2 the designated Emergency Stop buttons to turn off the power to the X-ray and all moving parts in order for the Patient to be safely removed from the machine. There is an Operator E-stop button on the Operator Control Box and there is a Patient E-Stop button on the machine. The Emergency Stop(s) when activated will stop all movement of the machine and halt the x-ray, if it is firing.

4. Once the capture is complete, the Patient Door should be opened. The patient can now safely EXIT the machine.
 - If the patient is Standing, he/she should turn around while still on the platform, using the handlebars for support and step forward out of the machine.
 - If patient is doing an Upper Extremity scan, assist them in removing their upper extremity from the machine.
 - If using the Patient Chair for a non-weight bearing scan, unlock the wheels on the patient chair and remove the chair so that it is free from the machine. Lock the wheels on the patient chair. Then assist the patient out of the chair.
 - *The patient chair is not designed to be used for transporting the patient between rooms.
5. When the Next button becomes visible, click on it.
6. Once on the Quality screen, wait for all of the QA images to be present. Initially the QA screen will appear as in the following image.

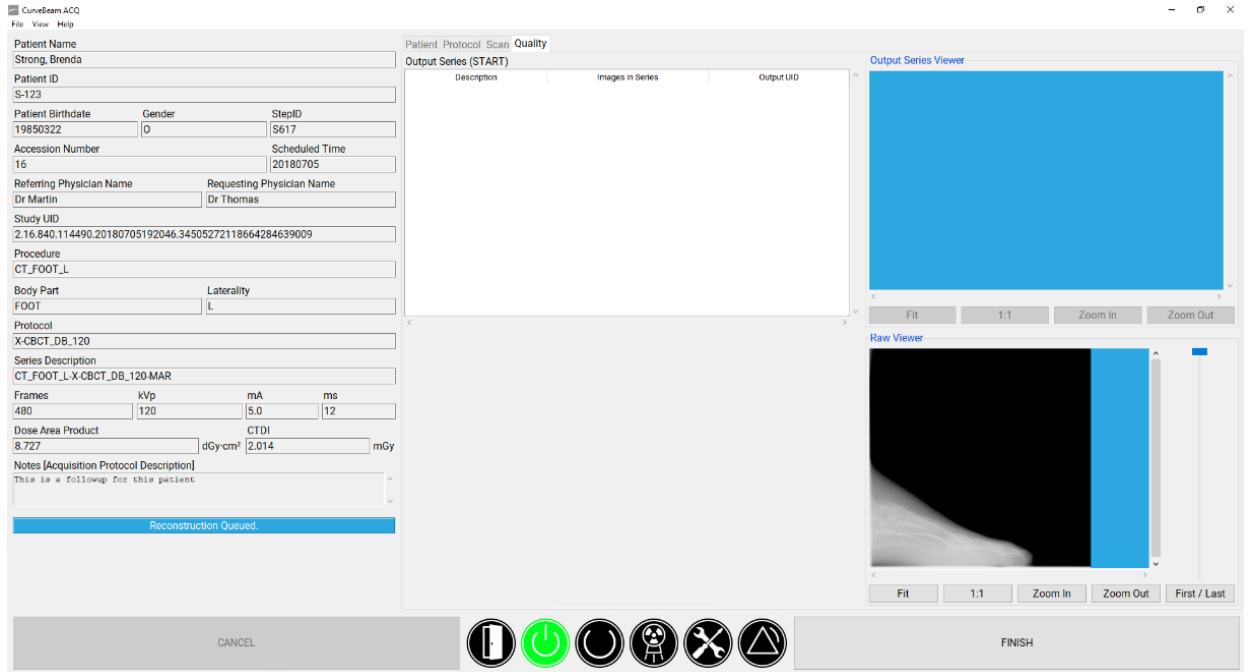

7. While waiting for the image to finish processing, check for movement of the patient during the scan, compare the first and last frames. View all images as they were acquired by using the slider below the raw frames. The Output Series Viewer can also be used to view the images, which may take a bit of time for images to appear.

8. Processing is completed once “DONE” appears next to Output Series as shown below:

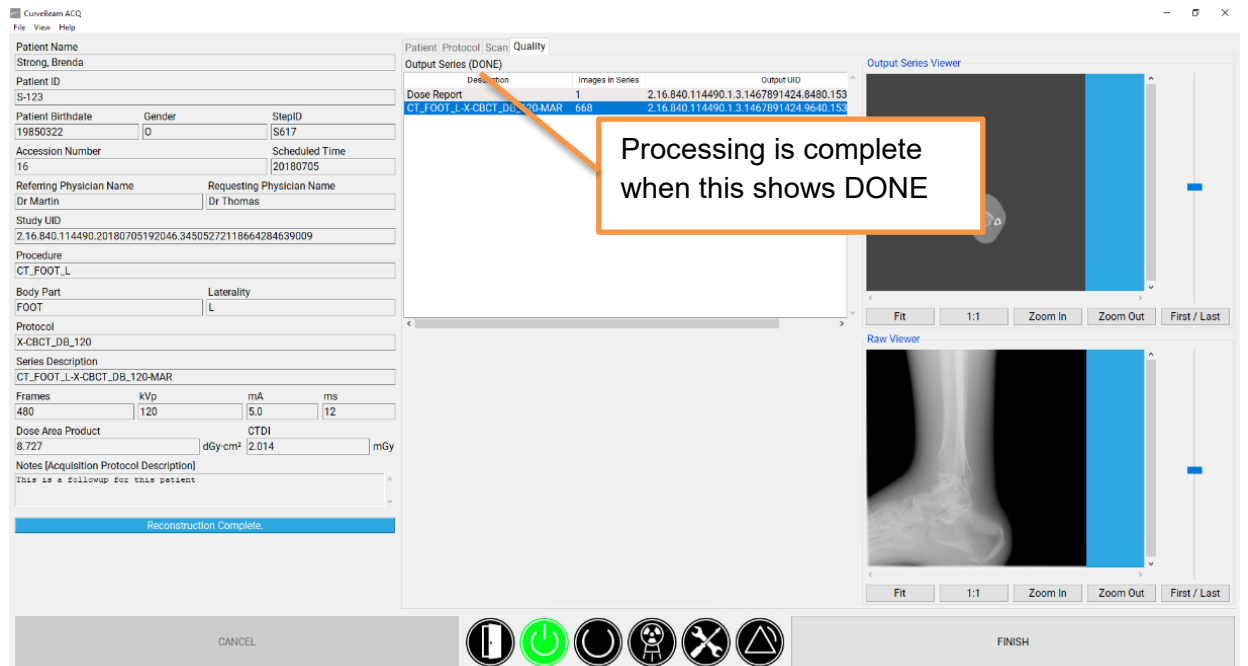

9. Once certain the image looks like the anatomy desired was done so acceptably, click on the Exit button and the software will close.

✔ NOTE: If there is any indication of vibration to the system, or malfunction to the system, or computer crash during a scan, please contact CurveBeam Technical Support for assistance. If there is a failed procedure, turn the machine off by the Emergency Stop button, following the below procedure.

Turning the System Off

To safely turn off the HiRise scanner, first close the Acquisition software. Then turn off the HiRise Scanner by using the power switch that is located on the bottom left side of the machine. This is the machine ON/OFF control. The vertical line is the ON position. The 0 is the OFF position. The HiRise scanner is only disconnected from the mains power when the power cord is disconnected from the outlet or the back of the machine. The operator should take care to keep access to the power outlet or power plug on the back of the machine clear in case the system must be disconnected from main power. Do not store any system accessories where access to the system mains will be blocked.

Viewing the Images

Image processing is done using iterative reconstruction of raw projections. Once the image is processed it is then formatted using the DICOM-3 file format. With this format, the image can then be viewed using a DICOM viewer. Both CT and x-ray images can be obtained from the scanner by setting up standard DICOM protocols for retrieving images from the DICOM storage device using the systems AETitle and Port.

CHAPTER 7: Patient Positioning

Before positioning the patient in the machine, ensure the patient will fit in the bore utilizing the patient hoop. Then, remove his/her shoes/socks for a foot scan. We recommend the patient not step bare foot on the patient platform. Proper foot protection should be provided.

The Patient should remove all loose-fitting clothing and take measures to assure that all longhair is kept out of moving sections of the device.

For a foot scan, if the patient has any jewelry on their toes or ankles, that should be removed. For a hand scan, if the patient has any jewelry on their fingers or wrists, that should be removed.

Have the patient put on medical gloves and foot protection as recommended in Ch. 2, Patient Preparation Recommendations section.

Drape the patient with protective shielding for the procedure as recommended in Ch. 1, Radiation Safety section.

The patient will now need to be positioned in the machine. For lower extremity weight bearing scans, the Patient Door to the machine should now be in the OPEN position in order for the patient to step in.

* Make sure the patient is properly positioned before clicking the “Begin Scan” button.

Weight Bearing Foot/Feet Scan

Assist the patient stepping into the scanner. Use the handles for stability. Refer to the section titled “Positioning the Foot/Feet” below for specific instructions on placing the feet. Once the patient is properly positioned, close the patient door, and place the gantry shields.

 **WARNING** Closing of the Patient Door creates a pinch point. Keep hands and feet clear when closing the Patient Door.

Once the scan is complete and the software instructs the operator to allow the patient to exit the scanner. Have the patient turn around, remove the gantry shields, and open the patient door. Instruct the patient to use the handlebars for stability while assisting them in exiting the scanner.

Weight Bearing Leg or Hip Scan

Position the patient in the AccuMeasure device and place the Knee Pointer (lower pointer) at the center of the Knee and the Hip Pointer (top pointer) at the Hip Joint. Hold down the AccuMeasure storage button until the blinking stops to store the measurements. Adjust the patient stabilizer to correspond to the same number at the knee pointer. Place the stabilizer next to patient platform within the gantry. Select the appropriately sized spacer for your patient and hang from stabilizer. Use Velcro strap around the patient's thighs for added stability.

 **WARNING** Closing of the Patient Door creates a pinch point. Keep hands and feet clear when closing the Patient Door.

Position the gantry shields. Then press the blinking motion button to raise the gantry to the scanning height, ensure that the patient remains in place while the gantry is raised before leaving to go back to the operator station to take the scan.

Once the scan is complete and the software instructs the operator to allow the patient to exit the scanner, remove the gantry shields and open the patient door. Then instruct the patient to use the handlebars for stability while assisting them in exiting the scanner.

Non-Weight Bearing Foot/Feet or Knees Scan – Utilizing Patient Chair

To begin, remove the step from the front of the HiRise. Then place the chair guide rail on the floor, attached to the front of the HiRise, where they step had been. Then move the chair so that it is just in front of the guide rail. Now lock the wheels on the chair, then lower the chair to the lowest height using the foot pedals. Once the chair is fully lowered, ensure that the patient side rail is down, on the side the patient will be sitting down. Assist them to sit in the chair and to bring their legs up on the chair. Then raise the side rail so that the patient has both side rails raised around them. Now raise the chair to the highest position, using the foot pedals. Once the chair is at the highest position, unlock the wheels and then using the chair guide rail, position the chair in the device. Utilize the lasers (the lasers are class M1 laser) to properly position the desired anatomy in the field of view. Lock the wheels on the patient chair once the patient is positioned for the scan.

 **NOTE:** Please review all warnings regarding safe use of the laser for patient positioning.

Once the scan is completed, unlock the wheels on the patient chair and move the chair from the scanner. Lock the wheels, lower the chair to the lowest position and lower the patient safety rails. Assist the patient out of the chair.

Upper Extremity Scan

Place the upper extremity platform and upper extremity shield. Have the patient place their hand or arm on the positioner and adjust the height of the gantry to a comfortable height. Place the two flexible upper extremity shields in place around the patient's anatomy. Make sure that loose fitting clothing has been removed and long hair is kept out of the device.

Positioning the Foot/Feet

Circular Positioning Guides:

These guides on the patient platform are intended to assist the operator in positioning the patient's feet/foot into the field of view.

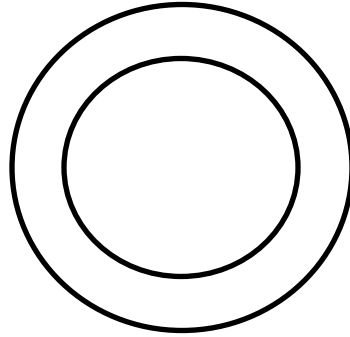

The most outer circle, large field of view (LFOV), is 43cm in diameter and is for single or bilateral foot or ankle procedures.

Positioning Illustrations are intended for Training purposes only.



Sample Results of Full both feet Field of View



The inner circle, the medium field of view (MFOV), is 26cm in diameter. This is for capturing one foot or a partial scan of one foot only. The area of interest for the scan should be positioned within this circle in order to capture it.

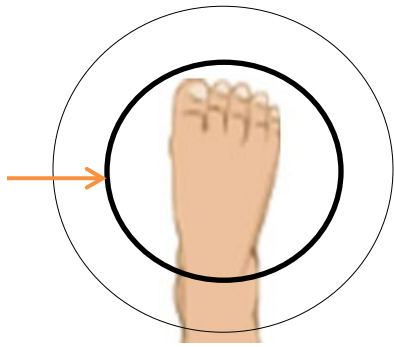

Sample Results of Partial Single Foot Diameter Scan

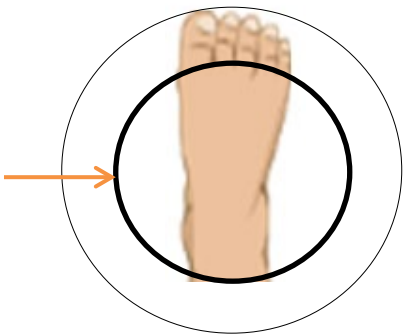
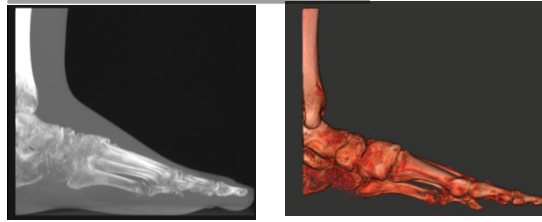

Sample Results of Partial Single Foot Diameter Scan



APPENDIX I: Troubleshooting

Warning Messages

System failures that may result in a scan failure will be accompanied by Warning Messages in the software. The user should follow the instructions to resolve the error, however if the Warning message persists, the user should contact CurveBeam technical support.

If the system fails to operate in any other way or if your problem is not listed, please contact CurveBeam technical support at the number listed on the front cover.

Message: Another instance of this program is already running.

How to Resolve: This message will appear when a second instance of the software is trying to be opened. If this occurs, close all visible instances of the acquisition software and try to open it again. If this still occurs, then open task manager and end the Acquisition Task.

Message: The system is busy.

Closing the application during an operation can lead to unexpected behavior.

Are you sure you want to terminate the application?

How to Resolve: This message will appear when trying to close the software while it is still working on the last task. Such as closing before the Quality Assurance screen has displayed the image from the last scan. If this occurs, allow the software to finish processing the task it is on, then attempt to close the software.

Message: Please assist the patient in exiting from the machine.

If the gantry is raised around the patient, use the Up/Down Controls to lower the gantry and then assist the patient in exiting the scanner PRIOR to clicking the OK button below.

Select OK only after patient is out of the scanner and scanner is clear.

How to Resolve: This message appears when the Cancel button is clicked while in the position patient portion of the scan workflow. If this occurs, it is critical that the operator use the Up/Down controls to lower the gantry down, so that the patient can safely exit the scanner.

Message: Please assist the patient in exiting from the machine.

If the patient is in the patient chair; unlock the wheels, move the chair away from the device, lock the wheels, lower the chair to the lowest position, lower the safety rails and assist the patient from exiting the chair.

Select OK only after patient is out of the scanner and scanner is clear.

How to Resolve: This message appears when the Cancel button is clicked while in the position patient portion of the scan workflow. If this occurs, it is critical that the operator use the Up/Down controls to lower the gantry down, so that the patient can safely exit the scanner.

Message: Temperature (NonCritical)

How to Resolve: This message appears just to inform the user that the system is functioning properly. The temperature is as it should be. No action is required.

Message: System Calibration was last performed: (date)

Please contact CurveBeam customer support to schedule maintenance.

How to Resolve: Calibrations should be performed annually. If it has been over a year since the system was calibrated, please contact CurveBeam to schedule the annual maintenance for the system.

Message: The following error occurred while scanning:

DOOR_INTERLOCK: Safety interlock was disengaged during the scan.

The application will now close.

How to Resolve: This message will appear if the room door is opened during a scan. The x-ray will terminate, and the software will need to close. The patient will need to be rescanned.

Message: The following error occurred while scanning:

SCAN_BUTTON: Scan button was released during the scan.

The application will now close.

How to Resolve: This message appears if the scan button is released while x-ray is firing during a scan. The x-ray will terminate, and the software will need to close. The patient will need to be rescanned.

Message: The following error occurred while scanning:

FILAMENT_TIMER: The filament timer expired before the scan completed.

The application will now close.

How to Resolve: If this message appears, assist the patient out of the scanner. Then both the scanner and the acquisition software need to be restarted. To do this, close the acquisition software first. Then reach around to the back of the scanner and turn power off to the scanner. Allow it to wait in the OFF state for about 30 seconds. Then turn the scanner back ON. Then proceed to start up the acquisition software. If the problem persists, please contact CurveBeam technical support.

Message: The following error occurred while scanning:

STALL_DETECT: A gantry stall was detected during the scan.

The application will now close.

How to Resolve: Ensure there is nothing in the path of the gantry. Assist the patient out of the scanner. Then both the scanner and the acquisition software need to be restarted. To do this, close the acquisition software first. Then reach around to the back of the scanner and turn power off to the scanner. Allow it to wait in the OFF state for about 30 seconds. Then turn the scanner back ON. Then proceed to start up the acquisition software. If the problem persists, please contact CurveBeam technical support.

Message: The following error occurred while scanning:

An unknown error occurred during the scan.

The application will now close.

How to Resolve: If this message appears, assist the patient out of the scanner. Then both the scanner and the acquisition software need to be restarted. To do this, close the acquisition

software first. Then reach around to the back of the scanner and turn power off to the scanner. Allow it to wait in the OFF state for about 30 seconds. Then turn the scanner back ON. Then proceed to start up the acquisition software. If the problem persists, please contact CurveBeam technical support.

Message: The following error occurred while scanning:

The scanner acquired x out of y expected frames.

The application will now close.

How to Resolve: If this message appears, assist the patient out of the scanner. Then both the scanner and the acquisition software need to be restarted. To do this, close the acquisition software first. Then reach around to the back of the scanner and turn power off to the scanner. Allow it to wait in the OFF state for about 30 seconds. Then turn the scanner back ON. Then proceed to start up the acquisition software. If the problem persists, please contact CurveBeam technical support.

If any “Unhandled Exceptions” or “TimeoutError” occurs while using the scanner.

Both the scanner and the acquisition software need to be restarted. To do this, close the acquisition software first. Then reach around to the back of the scanner and turn power off to the scanner. Allow it to wait in the OFF state for about 30 seconds. Then turn the scanner back ON. Then proceed to start up the acquisition software. If the problem persists, please contact CurveBeam technical support.

HiRise Known Issues:

The following table lists out the known issues with the HiRise, along with the solutions to manage them.

Issue Number	Bug ID	Summary	Issue Description	Suggested Work Around
1	1288	Collimator encoder failure doesn't cause software fault.	Unplugging an encoder on the collimator allows the scan to be acquired. The encoder runs continuously when unplugged.	If the collimator is in the Field of view or a motor is heard that does not stop, call technical support.
2	1354	HiRise Radius Ulna - Orientation markers not correct in 3rd party viewer	Radius Ulna Scan does not have correct orientation labels in 3rd party viewer.	Place external marker on patient anatomy for external confirmation.
3	1355	HiRise Hands-Both scan does not display correct orientation markers in third party viewer.	Both Hands Scan does not have the correct orientation labels in 3rd party viewer.	Place external marker on patient anatomy for external confirmation.
4	1376	HiRise - Humerus scan does not display orientation markers correctly in 3rd party viewer.	Humerus Scan does not have the correct orientation labels in 3rd party viewer.	Place external marker on patient anatomy for external confirmation.
5	1404	GEOCSV file appendix for non MAR gets generated - MAR for BOTH MAR scan.	GEOCSV file for MAR and BOTH MAR scans is labeled incorrectly.	GEOCSV file is used by CurveBeam AI personnel only. The file can be ignored by device users.
6	1411	HRCQ: Sometimes the first frame in the raw data appears to be an empty field frame. So first/last GUI does not provide expected motion correction review.	During the QA phase of Acquisition the First/Last section used for detecting movement of the patient does not always show the first frame.	Motion can be detected by scrolling through all the available frames, using the second frame and last frame or the final reconstructed image.
7	1483	The page number in Super Volume Dose Report is superimposed in the results of the scan range field.	The page number is in the incorrect location on the super volume dose report.	The data that is important in the does report is still visible and the dose report is still acceptable to a radiologist.

Issue Number	Bug ID	Summary	Issue Description	Suggested Work Around
8	1488	Collimator calibration : Overall Status field remains as FAILED status, if a protocol first fails then passes.	During a CurveBeam AI calibration a calibrations status is reported incorrectly.	CurveBeam AI personnel are the only users that have access to this calibration. They are trained on what to do if this issue occurs.
9	1496	DynamicCollimatorY error occurs when the machine is in Vertical position and ACQ is restarted.	When starting ACQ while the machine is in the vertical position the collimator may timeout while initializing.	Restart the ACQ software and try initializing the machine again or contact tech support.
10	1497	Cosmetic: Overlap in Dose report with longer Patient Name and ID.	When a patient name is longer than 20 characters there will be some overlap on the name displayed in the dose report.	The data that is important in the dose report is still visible and the dose report is still acceptable to a radiologist.
11	1498	Single-Pass and Multi-Pass Dose Reports do not show the same MAR info under "Filter" tab in CubeVue.	When reviewing Dose reports in CubeVue the filter on the dose report is incorrect.	The filter is not important to the data in the dose report and has no effect on the data in the dose report. Ignore the filter when reviewing dose reports.
12	1499	Reformats Matrix size and slice thickness values are not correct for MFOV and LFOV per site.	When reformat are enabled during installation the default parameters do not match what may be required by the site.	During installation the reformat parameters are configured per the installation checklist and then reviewed by the onsite technician.
13	1529	Update all references of CurveBeam, to CurveBeam AI.	When CurveBeam AI personnel are performing a full calibration, the results are misleading.	CurveBeam AI personnel are the only users that have access to this calibration. They are trained on what to do if this issue occurs.

Issue Number	Bug ID	Summary	Issue Description	Suggested Work Around
14	1530	Toolshed: Aborting an AutoQA3D when LP fails, TS does not fail the protocol, it maintains the previous PASS status and date.	When CurveBeam AI personnel are performing a full calibration, the results are misleading.	CurveBeam AI personnel are the only users that have access to this calibration. They are trained on what to do if this issue occurs.
15	1540	RDRS - Target Region for Bilateral Shin is Unknown.	When performing a SHIN scan the anatomy target region in the RDSR is labeled as unknown.	This has been resolved in the deployment of the software and will occur for the end users of the software.
16	1541	CTDI, DAP wrong values on dose report, RDSR for vendor protocols.	When using specific vendor protocols the reported CTDI and DAP values are incorrect in the dose report.	The vendor protocols are not available to all sites. If you have the specific vendor protocols the protocol guide will have mention of this issue.
17	1546	Toolshed: AutoQA - DB 130_1_35, reads wrong material values on "puck_slice_num".	When CurveBeam AI personnel are performing a full calibration, the results are misleading.	CurveBeam AI personnel are the only users that have access to this calibration. They are trained on what to do if this issue occurs.
18	1548	Toolshed: Upon clean deploy, running all fov collimator (all fov selected), DB will fail.	When CurveBeam AI personnel are performing a full calibration, the results are misleading.	CurveBeam AI personnel are the only users that have access to this calibration. They are trained on what to do if this issue occurs.
19	1549	ACQ VM Tech1 Acc : Toolshed - Review QA Results don't display image results when TS is run as admin under tech1 account.	When CurveBeam AI personnel are performing a full calibration, the results are misleading.	CurveBeam AI personnel are the only users that have access to this calibration. They are trained on what to do if this issue occurs.

Issue Number	Bug ID	Summary	Issue Description	Suggested Work Around
20	1566	ToolShed: Intermittent "Database was disconnected or Phantom may not be placed corr." error during AutoQA.	When running AutoQA in Toolshed the operator may be presented with an error. This error is misleading.	When presented with this error message the operator can rescan the phantom to produce a passing calibration.
21	1567	Recon Manager gets into an endless loop giving Reconstruction Error (code= 0xd)	When CurveBeam AI personnel are performing a full calibration, a looped error will occur in the recon engine.	The technician can stop the loop by opening the recon engine and stopping the job.
22	1570	ACQ: Panel motor timeout error not translated - French - German	If the panel motor times out when moving to position the error message will not be in the German or French language.	The operator can restart the application and the panel motor error will go away. If it continues tech support will need to be notified.
23	1576	ACQ: ACQ application gives "AttributeError" message on scanner initializing when communication to the Embedded is down.	If the machine is turned off while starting the software the error message will be misleading.	Turning on the machine will properly initialize the machine.
24	1580	SYSHR-290 - the total exam DAP isn't displayed in Dose Report	The Total DAP for multipass scans is not listed in the report.	The Operator can open the report and add the multipass values to determine the total DAP for the multipass scan.
25	1559	Recon puts incorrect value into largest pixel value tag when high voxel value in dataset	A reconstructed volume may have the incorrect value for the largest pixel value.	The Window level in the viewing software may need to be adjusted to properly visualize the anatomy.
26	1288	Collimator encoder failure doesn't cause software fault.	Unplugging an encoder on the collimator allows the scan to be acquired. The encoder runs continuously when unplugged.	If the collimator is in the Field of view or a motor is heard that does not stop, call technical support.

Issue Number	Bug ID	Summary	Issue Description	Suggested Work Around
27	1354	HiRise Radius Ulna - Orientation markers are not correct in third party viewer.	Radius Ulna Scan does not have correct orientation labels in 3rd party viewer.	Place external marker on patient anatomy for external confirmation.
28	1355	HiRise Hands-Both scan does not display correct orientation markers in third party viewer.	Both Hands Scan does not have the correct orientation labels in 3rd party viewer.	Place external marker on patient anatomy for external confirmation.
29	1376	HiRise - Humerus scan does not display orientation markers correctly in 3rd party viewer.	Humerus Scan does not have the correct orientation labels in 3rd party viewer.	Place external marker on patient anatomy for external confirmation.

APPENDIX II: Scan Protocol Technical Details

HiRise Study Type:	Cone Beam CT for Foot, Feet, Knees, Hips, Hand, and Elbow
Scan Positions/Orientations:	Weight Bearing (standing), Non-Weight Bearing (Non-Weight Bearing Chair)
CT Scanner make and model:	CurveBeam HiRise
Maximum # of Slices per acquisition:	N/A: System is Volume Cone Beam CT

HiRise has 10 CT Scan Protocol options. The tables below depict the five sets of Field of view and kVp combinations. Each combination includes two protocols, one for tube up and one for tube down position (regardless of tube position, the technical specifications are the same). The description of the Protocols is as follows:

Acquisition series (include all) (i.e., axial, helical)	Medium Field 100 kVp (lite patient)	Medium Field 120 kVp
Protocol Codes	X-CBCT_DC_100 X-CBCT_UC_100	X-CBCT_DC_120 X-CBCT_UC_120
kVp/mA and rotation time or kVp/mAs	kVp = 100 mA = 5.5 mAs = 47.52/31.68 Rotation time = 26 sec	kVp = 120 mA = 5.5 mAs = 47.52/31.68 Rotation time = 26 sec
CTDI (vol) required (if on system)	2.167 mGy/1.47 mGy	3.732 mGy/2.48 mGy
Dose length product (DLP) required if on system	-	-
Total dose per acquisition and/or total dose per study if available in units given	Dose Area Product = 11.58/8.088 dGy*cm ²	Dose Area Product = 20.3/14.03dGy*cm ²
Tube current modulation or dose reduction technique (is used)	12 millisecond pulses, 720 pulses/scan	12 millisecond pulses, 720 pulses/scan
Anatomical Scan range (i.e., dome of liver thru pubic symphysis)	L or R midfoot L or R midfoot & forefoot L or R hand, wrist, or elbow L or R Radius/Ulna or Humerus	L or R midfoot L or R midfoot & forefoot L or R hand, wrist, or elbow L or R Radius/Ulna or Humerus
Increment (space between slices)	0 mm	0 mm
Detector collimation (mm)	Fixed 5% of detector, factory calibrated	Fixed 5% of detector, factory calibrated
Slice thickness (mm)	0.31mm +/-0.5mm	0.31mm +/-0.5mm
Slice spacing (mm)	0.3mm	0.3mm

Pitch or table feed	0	0
Scan FOV (cm)	26.0 cm diameter x 20.0 cm height	26.0cm diameter x 20.0 cm height
Kernel/filter	-	-
Reformat technique (i.e., 3D, plane/views)	Automatic	Automatic
Contrast type/rate (if applicable)	Not Used	Not Used
Time from contrast injection to image acquisition, if applicable (sec)	Not Used	Not Used

Acquisition series (include all) (i.e., axial, helical)	Large Field 100 kVp	Large Field 120 kVp
Protocol Codes	X-CBCT_DB_100 X-CBCT_UA_100	X-CBCT_DB_120 X-CBCT_UA_120
kVp/mA and rotation time or kVp/mAs	kVp = 100 mA = 5.5 mAs = 47.52 Rotation time = 26 sec	kVp = 120 mA = 5.5 mAs = 47.52 Rotation time = 26 sec
CTDI (vol) required (if on system)	1.056 mGy/1.27 mGy	1.950 mGy/2.23 mGy
Dose length product (DLP) required if on system	-	-
Total dose per acquisition and/or total dose per study if available in units given	Dose Area Product = 11.1/12.12 dGy*cm ²	Dose Area Product = 19.64/21.34 dGy*cm ²
Tube current modulation or dose reduction technique (is used)	12 millisecond pulses, 720 pulses/scan	12 millisecond pulses, 720 pulses/scan
Anatomical Scan range (i.e., dome of liver thru pubic symphysis)	- L or R entire foot - Bilateral feet, knees - Non-Weight Bearing Feet	- Bilateral Hip/Pelvis, femur, knees, shin, feet - Non-Weight Bearing feet and knees
Increment (space between slices)	0 mm	0 mm
Detector collimation (mm)	Fixed 5% of detector, factory calibrated	Fixed 5% of detector, factory calibrated
Slice thickness (mm)	0.31mm +/-0.5mm	0.31mm +/-0.5mm
Slice spacing (mm)	0.3mm	0.3mm
Pitch or table feed	0	0

Scan FOV (cm)	43.0 cm diameter x 20.0 cm height	43.0 cm diameter x 20.0 cm height
Kernel/filter	-	-
Reformat technique (i.e., 3D, plane/views)	Automatic	Automatic
Contrast type/rate (if applicable)	Not Used	Not Used
Time from contrast injection to image acquisition, if applicable (sec)	Not Used	Not Used

Acquisition series (include all) (i.e., axial, helical)	Large Field 130 kVp (Standard patient)
Protocol Codes	X-CBCT_DB_130 X-CBCT_UA_130
kVp/mA and rotation time or kVp/mAs	kVp = 130 mA = 6.5 mAs = 163.8 Rotation time = 55 sec
CTDI (vol) required (if on system)	7.276 mGy/6.411 mGy
Dose length product (DLP) required if on system	-
Total dose per acquisition and/or total dose per study if available in units given	Dose Area Product = 78.51/72.016 dGy*cm ²
Tube current modulation or dose reduction technique (is used)	35 millisecond pulses, 720 pulses/scan
Anatomical Scan range (i.e., dome of liver thru pubic symphysis)	- Bilateral Hip/Pelvis, femur, knees
Increment (space between slices)	0 mm
Detector collimation (mm)	Fixed 5% of detector, factory calibrated
Slice thickness (mm)	0.31mm +/-0.5mm
Slice spacing (mm)	0.3mm
Pitch or table feed	0
Scan FOV (cm)	43.0 cm diameter x 20.0 cm height

Kernel/filter	-
Reformat technique (i.e., 3D, plane/views)	Automatic
Contrast type/rate (if applicable)	Not Used
Time from contrast injection to image acquisition, if applicable (sec)	Not Used

APPENDIX III: Pediatric Use Summary

The HiRise is intended to be used on patients ranging from 40 to 450 pounds (18.1 to 204 kg). Pediatric use is only intended for CT imaging.

Introduction: Special care should be exercised when imaging patients outside the typical adult size range, especially smaller pediatric patients whose size does not overlap the adult size range (e.g., patients less than 50 kg (110 lb) in weight and 150 cm (59 in) in height, measurements, which approximately correspond to that of an average 12 year old or a 5th percentile U.S. adult female).

Exposure to ionizing radiation is of particular concern in pediatric patients because: 1) for certain organs and tumor types, younger patients are more radiosensitive than adults (i.e., the cancer risk per unit dose of ionizing radiation is higher for younger patients); 2) use of equipment and exposure settings designed for adults of average size can result in excessive and unnecessary radiation exposure of smaller patients; and 3) younger patients have a longer expected lifetime over which the effects of radiation exposure may manifest as cancer.

To help reduce the risk of excessive radiation exposure, you should follow the ALARA (As Low As Reasonably Achievable) principle and seek to reduce radiation dose to only the amount necessary to obtain images that are adequate clinically.

The HiRise Provides the following specific design features and instructions that enable safer use of our device with pediatric patients:

- a. Page 90 provides recommendations for selecting a protocol appropriate for the patient size
- b. Page 6 advises Patients less than 21 years old and small size patients (under 100 pounds) must also wear a gonad and ovarian front and back protective shield.
- c. Page 10 advises that Patient must wear protective X-ray shielding items (lead apron, etc.) to protect anatomical areas. The patient must wear a protective full wrap X-ray shielding apron (lead apron) during a scan unless the Hip or Pelvis are to be imaged. Patients less than 21 years old, small size patients (under 100 pounds) and children must also wear a gonad and ovarian front and back protective shield when appropriate for the anatomy being imaged
- d. Testing information
 - i. Estimated dose for all protocols provided in APPENDIX II: Scan Protocol Technical Details
 - ii. Cone Beam CT Performance Testing starting on page 64 has tests for normal size patient (120 kVp) protocols and small patient (100 kVp) protocols
 - iii. Quality Assurance Check Instructions are provided in Chapter 4 and are the same for normal and small patient protocols