

Operator's Manual

LineUP

Computed Tomography Imaging X-ray System



2800 Bronze Drive, Suite 110

Hatfield, PA 19440

Ph: 267-483-8081

Fax: 267-483-8086

info@curvebeam.com

www.curvebeam.com

CurveBeam Technical Support: 267-483-8081

Table of Contents

CHAPTER 1: Introduction	6
Warnings, Cautions, Advice, and Notes	6
Safety Precautions	7
Electrical Hazards	8
Explosion Hazard	8
Mechanical Hazards	9
Radiation Safety	9
System Safety Devices	10
Cabling Requirements	10
System Description	10
Major Device Components	11
Intended Use of the Device	14
Major System Items	14
Intended User Profile	14
Contraindications	14
About the Operators' Manual	15
Conventions Used in the User Manual	15
Warranty	15
CHAPTER 2: Product Information	16
Technical Specifications	16
Power Requirements	19
Apparent Resistance of Supply Mains	20
Environmental Specifications	20
Electromagnetic or other Interference (Emissions and Immunity)	22
Equipment Standards	23
Equipment Class	24
Regulatory Class	24
Cleaning	25
Patient Preparation Recommendations	25

Preventive Maintenance Schedule - for Owner / User	26
Planned Maintenance – Monthly Schedule	26
Planned Maintenance - Annual Schedule	27
UPS (Uninterruptible Power Supply) Maintenance.....	27
Cyber Security Recommendations	27
Replacement Parts	28
Accessories.....	28
System Dimensions	29
CHAPTER 3: Safety Items.....	32
System Safety Devices	32
Emergency Removal of a Patient	33
Recommended Coverings	35
System Labels.....	36
System Controls and Indicators	48
CHAPTER 4: Calibration and Quality Assurance (QA) Procedures	50
Calibration Procedures	50
Quality Assurance Procedures	51
Radiation Output Test.....	57
CHAPTER 5: Radiation Environment Survey.....	58
Scatter Measurements.....	58
CTDI Measurements.....	59
Dose Profile	60
Modulation Transfer Function (MTF).....	61
Uniformity	63
CT Number Accuracy.....	64
Tomographic Slice Accuracy	64
2-D Imaging Mode	65
Reproducibility	65
Half value layer	65
Exposure-mAs Linearity	66
Timer Accuracy.....	67
Z-axis point spread function	70

Recommended Operating Requirements	70
Site Survey.....	71
X-ray Tube Assembly.....	72
Beam Path and Angulation	74
CHAPTER 6: Operations - Acquiring a Scan	75
System Startup.....	75
PATIENT Tab: Accessing/Entering Patient Information & Selecting Scan Procedure	76
PROTOCOL Tab: Selecting the Protocol	80
RECOMMENDATIONS for Selecting a Protocol	81
SCAN Tab: Performing the Acquisition	82
Turning the System Off	86
Viewing the Images.....	86
CHAPTER 7: Patient Positioning	87
3D Positioning	87
Weight Bearing Foot/Feet Scan	88
Non-Weight Bearing Foot/Feet Scan – Utilizing Multi-Extremity Chair.....	89
Non Weight Bearing Foot/Feet Scan – Utilizing Multi-Extremity Chair (only for LineUP Serial Numbers LU30001 and LU30002)	91
Non-Weight Bearing Foot/Feet Scan – Utilizing Patient Bench.....	92
Non-Weight Bearing Foot/Feet Scan – Utilizing Multi-Extremity Stowaway Bench	94
Positioning the Foot/Feet	99
3D Knees	101
3D Hand and Elbow – Utilizing Multi-Extremity Chair	103
3D Hand and Elbow – Utilizing Multi-Extremity Stowaway Chair.....	110
2D Positioning	121
Weight-bearing Lateral Foot	121
Weight-bearing AP/PA Feet	121
Weight-bearing Lateral Knee	122
Weight-bearing AP/PA Knees.....	122
2D Hand.....	123
2D Elbow	123
APPENDIX I: Troubleshooting.....	124

Warning Messages..... 124
APPENDIX II: Scan Protocol Technical Details..... 127
APPENDIX III: Pediatric Use Summary..... 131

LineUP User's Manual

CHAPTER 1: Introduction

In order to maintain the safety of patient's and operators of this device, it is important to operate and maintain the system correctly, following all instructions, warnings, cautions in this manual and labeling on the system itself. Installation Instructions are detailed in Appendix I.

The LineUP has been evaluated against European MDD requirements and carries the  0413 mark.

This manual covers all functions and protocols that are available on the LineUP, some of which are optional. Hence, some options listed here may not be available with your current device configuration. Please contact CurveBeam if you wish to add optional functionality shown here.

For technical support or questions contact CurveBeam at 267-483-8081

Warnings, Cautions, Advice, and Notes

Before attempting to operate the equipment, it is recommended that you read this manual thoroughly including all cautions and warnings. This guide uses the following conventions to describe situations that are potential hazards to the Patient or Operator, potential loss of data, or potential damage to the equipment.

WARNING

Warnings are intended to alert the user that failure to follow the procedure could cause fatal or serious injury to the user, Patient, or any other person, or result in a misdiagnosis.

CAUTION

Cautions are intended to alert the user that failure to follow the procedure could cause damage to the equipment or cause loss of data.

NOTE

Notes are used to highlight important or unusual points to be brought to the attention of the operator.

Advice

Refer to user manual.

Safety Precautions

 **WARNING:** The X-ray device is intended to be used for patients 50 lbs (23 kg) to 400 lbs (181 kg) and groin area at least 22" (56 cm) above the floor. DO NOT use this device for any patient less than 50 lbs (23 kg) OR groin area less than 22" (56 cm) above the floor, whichever is more restrictive.

 **WARNING:** The patient must wear a protective full wrap X-ray shielding apron (lead apron) during a scan. Patients less than 21 years old, small size patients (under 100 pounds) and children must also wear a gonad and ovarian front and back protective shield.

 **WARNING:** The X-ray device may be dangerous to the Patient and Operator if you do not observe and follow operating instructions. Do not operate this system unless you have received training to perform a procedure.

 **WARNING:** Do not remove covers or cables on system. High voltage is present in the system. To avoid personal injury from electrical shock, do not operate the system with any covers open or cables removed.

 **WARNING:** This device may cause detrimental interaction with active implantable medical devices and body worn active medical devices. Consult the manufacturer of such devices for more information.

 **WARNING:** Closing of the Gate door creates a pinch point. Keep hands and feet clear when closing Gate.

 **WARNING:** Reclining and un-reclining of the Multi-Extremity Chair creates a pinch point. Keep hands clear when adjusting the back of the Multi-Extremity Chair.

 **WARNING:** The Gantry should not be raised with the Multi-Extremity Chair engaged for a scan or patient positioning.

 **WARNING:** The back of the Multi-Extremity Chair shall not be used as a seat.

 **WARNING:** No modification of this equipment is allowed.

 **WARNING:** Service and maintenance can only be performed by CurveBeam authorized service personnel. ONLY CurveBeam authorized replacement parts can be used in the equipment. These requirements must be followed in order to avoid a hazard to the equipment, operator and/or patient.

 **WARNING:** This device connects to the customer IT-Network in order for the customer to access scan data for diagnostics. Failure of the customer IT-Network may interrupt or delay access to scan data. Updates or changes to the customer's IT-Network could introduce new risks that may require additional analysis. The customer is responsible for identifying, analyzing, evaluating, and controlling these risks associated with any IT-Network change.

 **WARNING:** Only CurveBeam supplied platforms, chairs, and accessories can be used when operating the scanner and scanning patients.

 **WARNING:** The Operator should always watch patient while raising or lowering any part of the Multi-Extremity Chair.

 **CAUTION:** When initiating an exposure, the external Warning Light is activated a few seconds before the X-ray ON alarm (buzzer) and X-ray ON lights are activated.

 **CAUTION:** Federal law restricts this device to sale by or on the order of a physician (Rx only).

 **CAUTION:** No auxiliary software should be installed on the system server and thin client terminals.

Electrical Hazards

Installation and system wiring must meet all requirements of local governing authorities. Please check your local authorities and local codes to determine best practices for a safe installation. Do not place any liquid or food on any part of the consoles or other modules of the system. Observe all fire regulations. Fire extinguishers should be provided for both electrical and non-electrical fires. All operators should be fully trained in the use of fire extinguishers and other fire-fighting equipment and in local fire procedures.

 **WARNING:** In the event of an electrical fire, only use extinguishers that are labelled for that purpose. Using water or other liquids on an electrical fire can lead to fatal or other serious personal injury.

 **WARNING:** In the event of an electrical fire, to reduce the risk of electrical shock, try to isolate the equipment from the electric source before attempting to extinguish the fire.

 **WARNING:** To avoid risk of electric shock, this equipment must only be connected to a supply main with protective earth.

Explosion Hazard

Do not use the System in the presence of explosive gases or vapors, including anesthetic gases. Use of this system in an environment for which it is not designed can lead to fire or explosion.

 **WARNING:** This unit is not suitable for use in a flammable air mixture environment. If hazardous substances are detected while the system is turned on, do not attempt to turn off the system. Evacuate the area and then remove the hazards before turning off the system.

Mechanical Hazards

 **WARNING:** Do not operate the system with any covers open or removed. Operating the system with open or removed covers could expose mechanical operating systems that could cause serious or fatal personal injury to you or the Patient. Only qualified and authorized service personnel should remove covers from the system.

The system is designed to detect that the patient door is closed before a scan can initiate. If the patient door is not closed, then the Operator will be prompted to close the patient door and retry or cancel the scan.

Radiation Safety

X-rays are dangerous to both operator and others in the vicinity unless established safe exposure procedures are strictly observed. Use the following safety measures to ensure safety to the Patient and Operator. The useful and scattered beams can produce serious or fatal bodily injuries to Patients and persons in the surrounding area if used by an unskilled operator. Adequate precautions must always be taken to avoid or reduce exposure to the useful beam or to scattered radiation. Operators are strongly urged to comply with the current recommendations of the International Commission on Radiological Protection and, in the United States, the US National Council for Radiological Protection.

Use the following measures to protect yourself and the patient from unintended exposure to radiation. Anyone who is near the patient during test procedures must observe the following precautions:

- Maintain distance from exposed radiation source in accordance with the facility survey or site plan and shielding designs, provided by a medical physicist. The plan/survey will be created based off of Scatter Measurements provided in this manual. Refer to “typical LineUP Layout” towards the end of Chapter 5 of this manual for additional details.
- Keep exposure times to a minimum.
- The patient must wear a protective full wrap X-ray shielding apron (lead apron) during a scan. Patients less than 21 years old, small size patients (under 100 pounds) and children must also wear a gonad and ovarian front and back protective shield. Sample shielding products, or similar:
Supplier: Marshield, Full Wrap Apron, #MS-SP1
Supplier: Universal Medical Inc, Diaper 14" x 20", #800
- Wear a PEN dosimeter and/or film badge.
- If you are required in the exam room during a procedure, stay as far from the scanner as possible or behind a protective wall.
- The physician is responsible for protecting the patient from unnecessary radiation.

System Safety Devices

The system safety devices include an Emergency Stop, Warning System, and Interlock System. These are explained fully in Chapter 3 – Safety Items.

Cabling Requirements

System cabling connections must be installed away from walkways and doorways. It is recommended to run cabling along wall perimeters. If there is a chance of mechanical damage due to the cable location, then the use of conduit or other means of protection should be considered.

System Description

The LineUP is a Computed Tomography X-ray system or Cone Beam Volumetric Tomography x-ray system for 3D reconstruction Imaging device for the foot, knee, hand, and elbow. The system is designed for an in-office setting with components consisting of the Scanner, Operating Computer (External Server), and Operator's Console. The system provides for patient's to be imaged in weight bearing (standing) position as well as seated position for one or both feet.

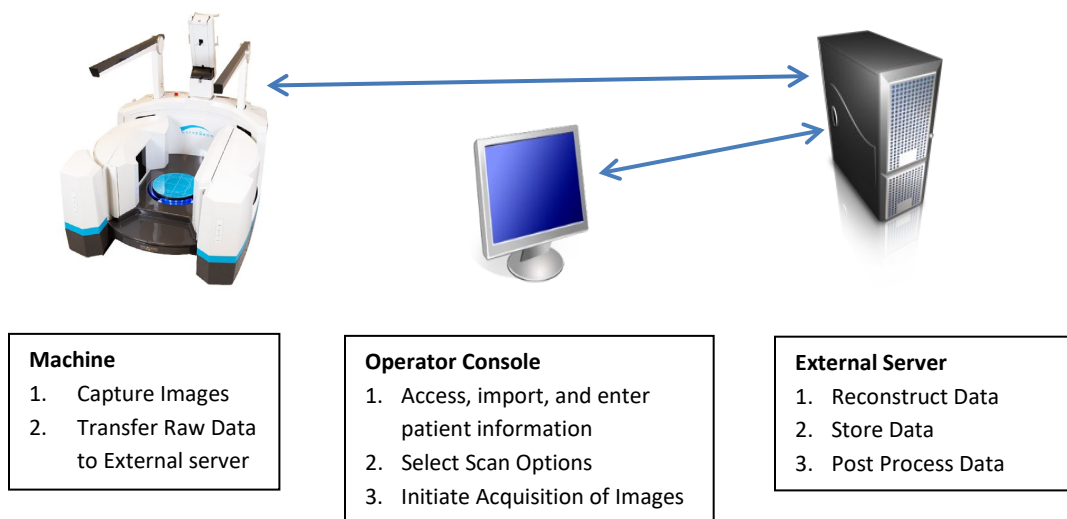

The External Server consists of 3 Virtual Machines:

ACQ VM: accessed via the Main Desktop icon on the ACQ thin client terminal

RECON VM: accessed via Remote Desktop Connection icon on the ACQ thin client terminal.

Database VM: accessed via Remote Desktop Connection icon on the ACQ thin client terminal.

Major Device Components

Scanner

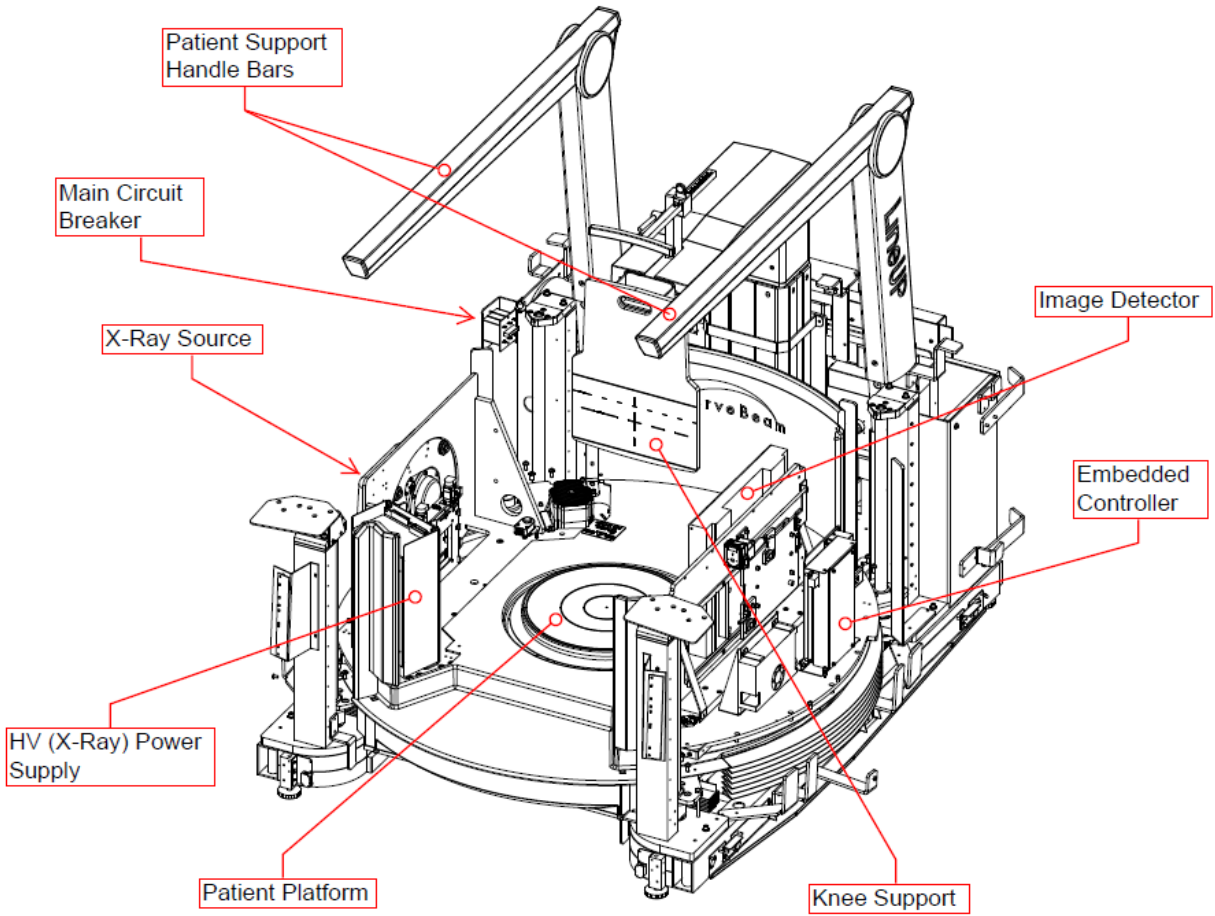

Multi-Extremity Chair

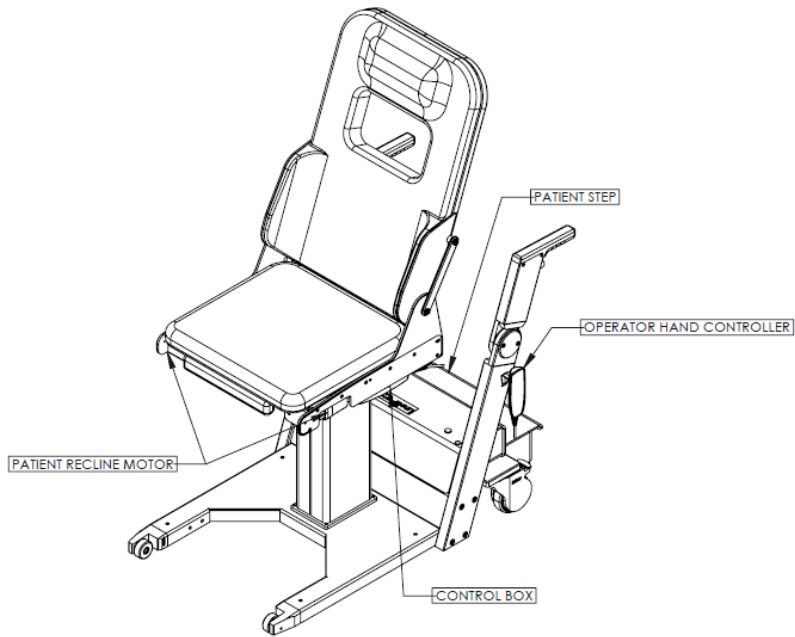

Patient Bench

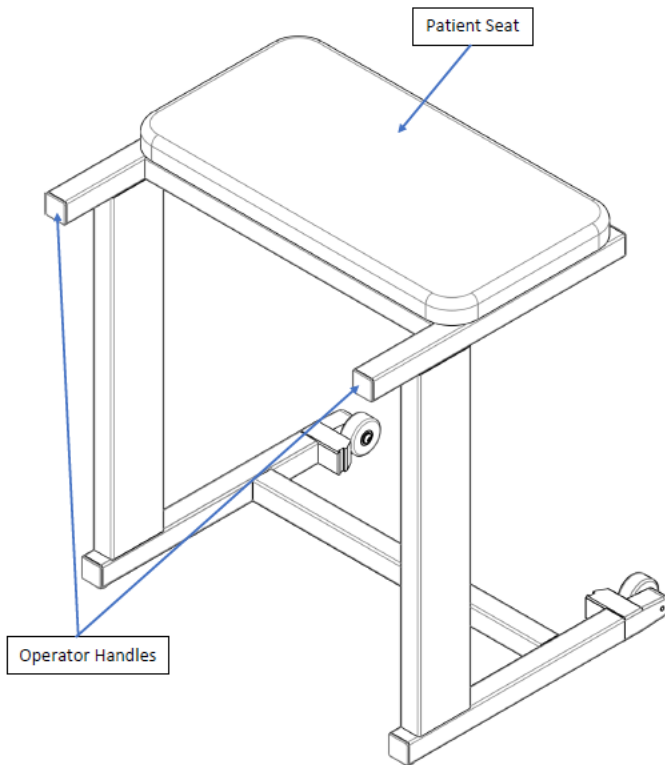

Stowaway Chair and Stowaway Bench

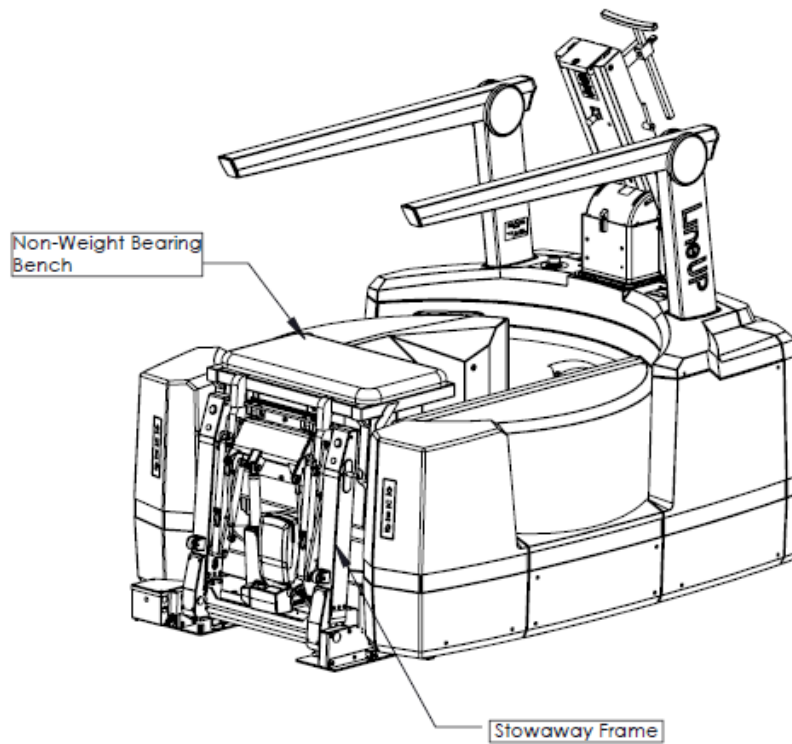
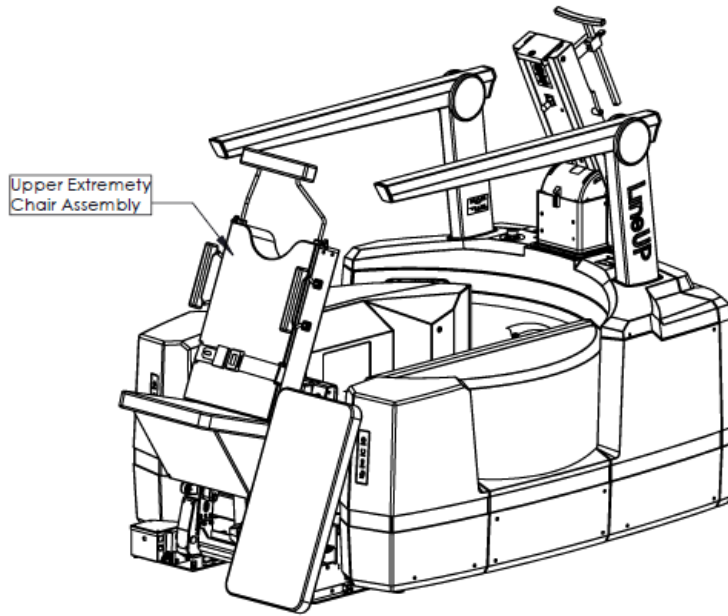

Intended Use of the Device

The LineUP is intended to be used for 3-D imaging of the foot, knee, hand, and elbow regions to visualize and assess the osseous and certain soft tissue structures, including joint spaces, bone angles and fractures.

It is also intended to capture 2-D images (standard plain x-ray projections) of the foot, knee, hand, and elbow regions.

This modality is anticipated to be applicable to pediatric* cases as well as adults, when appropriate diagnosis of a given condition is considered necessary. Patient parameters: 50 lbs to 400 lbs

*2D Imaging not intended for pediatric use

Major System Items

- Scanner
- Multi-Extremity Chair
- Patient Bench
- Dell server with hard drives, network cards, DVD drive, etc and Uninterrupted Power Supply (UPS)
- External Cable Kit
 - Door Interlock, 50' (15.24 m)
 - Warning System, 50' (15.24 m)
 - Door interlock, shorting plug
 - Operator Control Box Assembly, 50' (15.24 m)
- Ethernet Cable, CAT6, gray, 50' (15.24 m) (QTY 2)
- Ethernet cable, CAT 6, green, 50' (15.24 m)
- Ethernet cable, CAT6, red, 50' (15.24 m)
- Power cord, 10' (3.05 m)
- MX Imaging CMOS flat panel, CFP3131
- X-Ray tube assembly
- X-Ray power supply

Intended User Profile

The LineUP is intended to be used by an operator that meets all local, state, federal or international regulations and that has been trained by CurveBeam personnel using the LineUP On Site Training Checklist.

Contraindications

This device emits ionizing radiation. Exposure to ionizing radiation may cause damage to cells and may increase the risk of cancer later in life. Populations sensitive to exposure include pediatric and those that are pregnant.

About the Operators' Manual

This documentation describes the safe and effective operation of the system. The information is intended to provide trained Technologists and Physicians the necessary guidance to operate the system in a safe and effective manner.

CurveBeam assumes no liability for the use of this document if any unauthorized changes to the content or format have been made.

Conventions Used in the User Manual

Main Menu items and Tabs are in quotes (“ ”). Software Programs are in quotes (“ ”)

Interface buttons are capitalized” (BUTTON).

Warranty

CurveBeam Standard Warranty is available by request. Please contact CurveBeam Technical support to receive a copy of the Warranty.

CHAPTER 2: Product Information

Technical Specifications

Description	Specification
Tube voltage	60 kVp, 100 kVp, 120 kVp (+/-10%)
Tube current	5 mA (+/-10%)
CBCT Scan time*	21 sec MFOV, 25 sec LFOV
X-Ray Scan time*	0.15 – 1.3 sec
CBCT Procedure time**	Foot, hand, and elbow (Gantry at bottom position): 44 sec Knees (Gantry at an elevated position): 112 sec
X-Ray Procedure time**	5 sec
CT Max exposure time (based on typical pulse width)	8.7 sec
X-Ray max exposure time	1.3 sec
Image detector	CMOS Flat Panel
Gray scale	14 bit
CBCT Imaging Volume	7.9" (20 cm) height x 13.8" (35 cm) diameter, 7.9" (20 cm) height x 7.9" (20 cm) diameter
Typical slice thickness	0.3mm (+/-0.5mm); Slice Spacing 0.3 mm
Typical voxel size	0.3 mm
Measurement accuracy	± 2 voxel
X-Ray pixel size / x-ray resolution	0.099 mm
Body parts scanned	Foot, knee, hand, and elbow
Size of system: h x d x w	50"x63"x49" (127 cm x 159 cm x 125 cm)
Weight	Scanner 750 lb (340 kg), Multi-Extremity Chair 250 lb (113 kg), Patient Bench 24 lb (11 kg)
Power Requirements	1150VA

*Scan time is defined as the duration in which the exposure alarm (buzzer) is ON and X-ray ON light is illuminated.

**Procedure time is from time the exposure button is pressed to when the gate can be opened or Multi-Extremity Chair can be wheeled out of scanner after the scan.

X-ray Source:

Tube Voltage: 60 kVp(eff), 100 kVp(eff), 120 kVp(eff), +/- 10%

Tube Current: 5 mA, +/- 10%

Voltage Wave Shape: Constant Potential

Focal Spot: 0.0197 inches (0.5 mm)

Duty Cycle: 3%

Source to Sensor distance: 29.956" (76.11 cm)

Source to Patient distance: 20.802" (52.84 cm***)

***The patient must be properly positioned for each patient for all applications in order to have the focal spot to skin distance as large as possible.

Minimum Filtration (at 120 kVp(eff)) (mm of aluminum equivalent): 10 mm or greater

Maximum Rated Continuous Tube Operation: 130 kVp @ 0.5 mA

Maximum Rated Pulsed Tube Operation: 130 kVp @ 5mA

 **NOTE:** Leakage technique factors are measured at the maximum specified energy.

Timer: \pm 0.1 seconds or 5%, whichever is greater

X-ray Beam Size: 12.2" (30.96 cm) wide x 12.2" (30.96 cm) high

Image Detector: CMOS Flat Panel (readable area): 12.2" (30.96 cm) height x 12.2" (30.96 cm) width.

Sensor Front Panel Attenuation Value: Less than 1mm of aluminum equivalent (information for reference only)

Gray Scale: 14 bit

Voxel Size: 0.3

X-Ray Pixel Size: 0.099mm x 0.099mm

CBCT Image Acquisition: 1 orbit, 360-degree rotation (maximum)

CBCT Field of View: 7.9" (20 cm) diameter x 7.9" (20 cm) height (1/2 or 1 orbit)

X-Ray FOV: 12" (30 cm) x 12" (30 cm)

CBCT Extended Field of View: (offset scan): 13.8" (35 cm) diameter x 7.9" (20 cm) height

CBCT Procedure Times: 44 sec for Gantry down (foot, hand, and elbow) 112 sec for Gantry Lift (knees)

X-Ray Procedure Times: 5 sec

CBCT Patient options available for scanning:

Patient Parameters	Exposure Factors	Type
<i>Small Size:</i> Weight: 50 to 100 lbs (23-45 kg)	100 kVp, 5mA	Medium Field (100kVp)
<i>Small Size:</i> Weight: 50 to 100 lbs (23-45kg)	100 kVp, 5mA	Large Field (100kVp)
Weight: 101 to 400 lbs (46-181 kg)	120 kVp, 5mA	Medium Field (120kVp)
Weight: 101 to 400 lbs (46-181 kg)	120 kVp, 5mA	Large Field (120kVp)

X-Ray Patient Protocol options available for scanning:

Protocol (patient size is included with protocol names)	Exposure Factors	Time	Anatomy
Hand PA Standard	60 kVp, 5mA	300ms	Hand
Hand Lateral Standard	60 kVp, 5mA	600ms	Hand
Hand PA Lite	60 kVp, 5mA	150ms	Hand
Hand Lateral Lite	60 kVp, 5mA	400ms	Hand
Elbow AP Standard	60 kVp, 5mA	600ms	Elbow
Elbow Lateral Standard	60 kVp, 5mA	600ms	Elbow
Elbow AP Lite	60 kVp, 5mA	400ms	Elbow
Elbow Lateral Lite	60 kVp, 5mA	400ms	Elbow
Two Feet AP Standard	60 kVp, 5mA	800ms	Feet
One Foot Lateral Standard	60 kVp, 5mA	800ms	Foot
Two Feet AP Lite	60 kVp, 5mA	500ms	Feet
One Foot Lateral Lite	60 kVp, 5mA	400ms	Foot
Two Knees AP Standard	60 kVp, 5mA	1300ms	Knees
Two Knees PA Standard	60 kVp, 5mA	1300ms	Knees
One Knee Lateral Standard	60 kVp, 5mA	1200ms	Knee
Two Knees AP Lite	60 kVp, 5mA	1000ms	Knees
Two Knees PA Lite	60 kVp, 5mA	1000ms	Knees
One Knee Lateral Lite	60 kVp, 5mA	750ms	Knee

CBCT Primary Reconstruction:

- **Medium Field of View options:** Maximum 2 minutes
- **Large Field of View options:** Maximum 3 minutes

CBCT Secondary Reconstruction: Real Time

Gantry Stopping Distance and Angle: Total rotation from Home position to limit is 424 degrees (Home being 0 degrees). “Load” position (gantry aligned for patient to walk in) is 25 degrees from home position.

Essential Performance:

- X-Ray Specifications – Technique Factors (kV, mA, Time)
- Power Supply Regulation
- Imaging Chain (digital image receptor and 3D reconstruction engine)
- X-Ray Filtration / Half Value Layer
 - Not affected by any electromagnetic phenomenon

Unless otherwise stated above, in the event an electromagnetic phenomenon degrades any of the essential performance items, an operator can expect possible lost or missed images, need for patient re-scan, or the possibility of degradation in image quality.

Power Requirements

The Scanner requires a Dedicated Line and/or Filtered Line. A Surge Protector is recommended. The Scanner is suitable for continuous connection to a power supply in stand-by mode.

Line Voltage: 115VAC \pm 10% (Factory Set)

230VAC \pm 10% (which covers 220, 230 and 240 VAC power supplies)
(Factory Set)

Line Current: 10 Amps (115V) or 5 Amps (230V)

Line Frequency: 50 Hz / 60 Hz

Phase: Single

Main Circuit Breaker: 10 Amps (115V) or 5 Amps (230V)

Nominal Electrical Input Power to Supply: CT Volume Scan = 300W (120kV, 5mA);
2D X-Ray Scan 150W (60kV, 5mA); Scan Time has no effect on electrical power output.

Apparent Resistance of Supply Mains

For the purpose of obtaining the apparent resistance of supply mains, resistance is determined according to the following formula:

$$R = \frac{U_0 - U_1}{I_1}$$

Where:

U₀ is the no-load Mains Voltage

U₁ is the Mains Voltage under load.

I₁ is the Mains Current under load.

Circuit Breaker Assembly	U₀	U₁	I₁	Apparent Resistance
115VAC	115.4VAC	114.2VAC	2.1A	0.57ohms
230VAC	230.8VAC	228.0VAC	1.2A	2.33ohms

Environmental Specifications

Operating:

- The operational temperature range shall be 59°F to 86°F (+15°C to +30°C).
- The operational humidity range shall be 25 to 60% relative humidity, non-condensing.
- The minimum time period that the room environmental operating conditions must be maintained prior to powering the system is 1 hour.
- The operational atmospheric pressure range shall be 94 kPa to 102 kPa.

Transportation and Storage:

- The storage and transport temperature range shall be -4°F to 122°F (-20°C to +50°C).
- The storage & transport humidity range shall be 10% to 95% relative humidity, non-condensing.

Scanner and Acquisition Computer (server):

- Requires a Dedicated Line and a Surge Protector is recommended.

Patient Platform:

- Maximum patient weight capacity: 400 lbs. (181 kg)

Handle Bars:

- Maximum weight capacity: 100 lbs. (45 kg)

Multi-Extremity Chair:

- Maximum patient weight capacity: 400 lbs. (181 kg)

Patient Bench:

- Maximum patient weight capacity: 300 lbs. (136 kg)

Environmental Impact:

The LineUP display monitors can be powered off when not in use, to minimize power consumption and environmental impact.

The LineUP scanner can be powered off when not in use, refer to the power up requirements listed in Chapter 6 before deciding to turn the scanner off, to minimize power consumption and environmental impact.

! **CAUTION:** Before powering off the LineUP scanner, be aware of the time requirement needed when powering up the LineUP scanner.

There are no options or adjustments the user can perform to minimize environmental impact during normal operation.

Disposal:

Follow local regulations on disposal of waste parts. The *X-ray source assembly, image sensor and all electronic circuits* should be regarded as non-environmentally friendly waste product. The system does not generate, or require the use of, any materials that require special disposal instructions as part of regular operation.

Extension Cords:

Do not use any extension cords which are not provided with the system. Be aware that multiple portable socket outlets or extension cords are not to be connected to the system.

External Items: Do not connect any items or equipment to this system which are not part of the system.

Instruction for maintaining BASIC Safety and Essential performance for the expected Service life

NOTE: Do not change the once installed final application due to EMC, view Immunity test levels (IEC 60601-1-2:2014)

Electromagnetic or other Interference (Emissions and Immunity)

The system was tested and it was determined to meet the class A (non-residential) limits. The system pass testing with a reduced level of compliance with the criteria contained in IEC 60601-1-2 Edition 3 Issued 03/2007 and IEC 60601-1-2 Edition 4 issued 02/2014.

Test Name	Test Level/ Equipment Class Edition 4	Test Level/ Equipment Class Edition 3	Results/Notes	Immunity Performance Criteria Met
Emissions Testing				
Radiated Emissions	Class A: Group 1	Class A: Group 1	Compliant	-
Conducted Voltage Emissions	Class A: Group 1	Class A: Group 1	Compliant	-
IEC61000-3-2 Harmonic Current Emissions	Class A	Class A	Compliant	-
IEC61000-3-3 Voltage Changes, Voltage Fluctuations and Flicker	Dmax = 4 %	Dmax = 4 %	Compliant	-
Immunity Testing				
61000-4-2 Electrostatic Discharge	±8 kV Contact, ±15 kV Air	±6 kV Contact, ±8 kV Air	Compliant	A
61000-4-3 Radiated Immunity	80 MHz – 2.7 GHz, 3 V/M, 80% AM with 1kHz	80 MHz – 2.5 GHz, 3 V/M, 80% AM with 1kHz	Compliant	A
61000-4-4 Electrical Fast Transients	100kHz repetition ±2 kV Power Supply Lines, ±1 kV Input/Output Lines	5kHz repetition ±2 kV Power Supply Lines, ±2 kV Input/Output Lines	Compliant	A
61000-4-5 Surge Immunity	±1 kV Line to Line, ±2 kV Line to Earth	±1 kV Line to Line, ±2 kV Line to Earth	Compliant	A
61000-4-6 Conducted Immunity	150 kHz – 80MHz, 3 Vrms 6 Vrms in ISM band between 0.15 MHz and 80 MHz 80 % AM at 1 kHz	150 kHz – 80MHz, 3 Vrms	Compliant	A
61000-4-8 Power Frequency Magnetic Field	30 A/M	3 A/M	Compliant	A
61000-4-11 Voltage Dips and Short Interruptions	135°, 180°, 225°, 270° and 315° % UT; 1 cycle 70 % UT; 25/30 cycles for 50 Hz and 60Hz, % UT; 250/300 cycle for 50 Hz and 60 Hz,	>95% dip for 0.5 periods	Compliant	A
		60% dip for 5 periods	Compliant	A
		30% dip for 230periods	Compliant	A
		>95% dip for 5 seconds	Compliant	C

 **WARNING** This system is intended for use by healthcare professionals only. This system may cause radio interference or may disrupt the operation of nearby equipment. Follow the following recommendations below.

Recommended separation distances between portable and mobile RF communications equipment and the LineUP

The LineUP is intended for use in an electromagnetic environment in which radiated RF disturbances are controlled. The customer or the user of the LineUP can help prevent electromagnetic interference by maintaining a minimum distance of 10 feet (3 m) between portable and mobile RF communications equipment (transmitters) and the LineUP. Refer to the portable and mobile RF communications equipment user's manual for recommended clearance distances to other equipment based on the maximum output power of the communications equipment. Maintain a minimum distance of 10 feet (3m) between the LineUP and portable and mobile RF communication equipment, otherwise, degradation of the performance of this equipment could result. Other cables and accessories may affect EMI performance. Use of this equipment adjacent to or stacked with other equipment should be avoided because it could result in improper operation. If such use is necessary, this equipment and the other equipment should be observed to verify that they are operating normally. Use of accessories, transducers and cables other than those specified or provided by the manufacturer of this equipment could result in increased electromagnetic emissions or decreased electromagnetic immunity of this equipment and result in improper operation. This equipment is designed to be used in industrial areas and hospitals (CISPR 11 class A) only. Therefore, the emissions characteristics have not been tested to comply with CISPR 11 group 2 Class B. This equipment is not suitable for use If it is used in a residential environment (for which CISPR 11 class B is normally required) this equipment might not offer adequate protection to radio-frequency communication services. The user might need to take mitigation measures, such as relocating or re-orienting the equipment.

Equipment Standards

The LineUP has been designed and evaluated to meet the requirements of the following standards. The device has passed all applicable sections of these standards.

ANSI/AAMI ES60601-1, third edition, 01/2005
BS EN 1041:2008
BS EN ISO 14971:2009
CSA C22.2 NO. 60601-1:08-CAN/CSA, third edition, 07/2008
EN ISO 15223-1:2012
IEC 60601-1, third edition, 12/2005
IEC 60601-1, second edition, 12/1995
IEC 60601-1-2, third edition, 03/2007
IEC 60601-1-3, first edition, 01/1994
IEC 60601-1-3, second edition, 01/2008
IEC 60601-2-54, first edition, 06/2009

IEC 60601-1-6, first edition, 01/2006
 IEC 60601-1-6, third edition, 01/2010
 IEC 60601-1-8, first edition, 1/2003
 IEC 60601-2-7, second edition, 02/1998
 IEC 60601-2-44, second edition, 01/2002
 IEC 60601-2-44, third edition, 02/2009
 IEC 62304, first edition, 05/2006
 ISO 15223-1:2012

The LineUP conforms to the provisions of MDD 93/42/EEC (as transposed into national law in the United Kingdom through Statutory instrument SI 618 2002 Medical Device Regulations 2002 and as amended by SI 2008 No. 2936).and Australian Medical Device Directives, TGA, v1.1, May, 2011

Equipment Class

- Protection against electric shock: Class I
- Applied part has degree of protection against electric shock: Class B
- Class of equipment against ingress of liquids: Ordinary Equipment: IPX0
- Radiated emissions: Class A

Regulatory Class

Governing Body	Classification
FDA	2
Health Canada	3
Medical Device Directive(93/42/EEC)	IIb

Cleaning

⚠ WARNING Prior to performing any cleaning, ensure the machine is not in use, and patient is not in the scanner.

Routinely and after each patient scan, clean and disinfect all items which could come in contact with the patient. As stated in patient preparation recommendations below, barriers should be used so that the patient does not come into direct contact with the device. By avoiding direct contact with the device, minimal soiling should occur during normal use.

Cleaning the equipment frequently, especially if corroding chemicals are present is a function of the Operator. Unless otherwise instructed, use a cloth moistened with warm water and mild soap. Do not use strong cleaners and solvents as these may damage the finish. Be careful when cleaning to avoid liquid leaking underneath the Platform Area and into the Gantry.

For disinfecting, use CaviWipes™ surface disinfectant wipes by Metrex™. Use on all surfaces that contact the patient as directed by the CaviWipes™ label. Do not spray any disinfectant directly onto the equipment.

Patient Preparation Recommendations

The patient must wear FDA cleared medical gloves for gripping the hand rails, with sanitation and convenience in mind.

The patient should not step bare foot on the patient platform. Proper foot protection should be provided.

The Multi-Extremity Chair should be lined with Exam Table Paper before the patient is seated on it.

The Patient Bench should be lined with Exam Table Paper before the patient is seated on it.

Line the knee positioner or hand platform (if using) with Medical Barrier Film.
CurveBeam tested brand: Clear Barrier Film – Low tack-adhesive (Palmero #1866C).

After each patient scan, clean and disinfect all items which come in contact with the patient.

Preventive Maintenance Schedule - for Owner / User

 **WARNING** Prior to performing any maintenance, ensure the machine is not in use, and patient is not in the scanner.

- *Daily:*

Routine Dusting - all surfaces.

Clean and Disinfect all items which come in contact with the patient after each patient scan.

- *Monthly:*

Clean/Disinfect all surfaces, check for failed/faulty indicator lights.

- *Annually:*

Panel Calibration.

Quality Assurance Procedure to check for satisfactory image quality.

Periodic system testing by factory trained Service Technician.

IT IS THE RESPONSIBILITY OF THE USER TO ENSURE THAT THE EQUIPMENT IS MAINTAINED IN COMPLIANCE WITH THE MANUFACTURER'S RECOMMENDED MAINTENANCE SCHEDULE. THE MANUFACTURER AND THE ASSEMBLER / INSTALLER ARE RELIEVED FROM RESPONSIBILITY IN THOSE CASES WHERE NON-COMPLIANCE WITH THE STANDARD RESULTS FROM THE USER'S FAILURE TO HAVE THE MANUFACTURER'S RECOMMENDED MAINTENANCE PERFORMED.

The actual maintenance inspection and consequent service must be accomplished either by an authorized factory trained technician or by a competent serviceman of the user's choice who has adequate training in those aspects of the Performance Standards of the Radiation Control for Health and Safety Act of 1968 that are applicable to this equipment. Neither the inspection nor service is part of the equipment warranty. (To be arranged for by the Owner or User with the Dealer's Service Department).

Planned Maintenance – Monthly Schedule

The system requires monthly maintenance check for failed or faulty indicators/lights. Check for failed or faulty indicators/lights. Contact CurveBeam Technical Support at the number on the front cover of this manual to assist with exercising the indicators/lights.

Planned Maintenance - Annual Schedule

The system requires normal periodic inspection and maintenance. Scheduled periodic inspections are necessary to detect problems which can result from excessive wear, loose items, chafing wires, and mis-adjusted parts from continual system use. Scheduled panel calibrations are necessary to determine if the image quality is suboptimal. The scan results may have symptoms of artifacts commonly referred to as “circle or ring artifacts”. Below are samples of circle artifacts in scan results. If these are observed then a panel calibration should be performed.

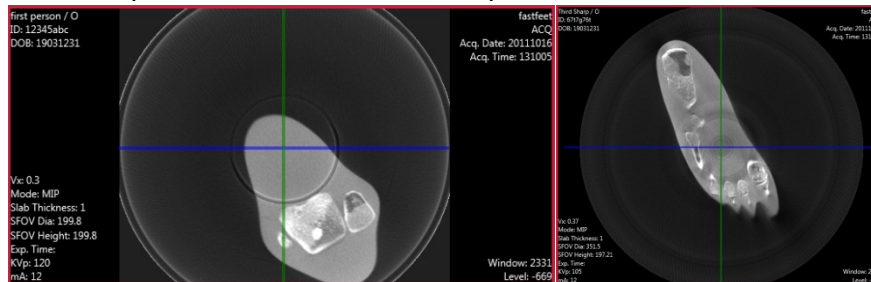

In addition to mechanical inspection and panel calibration, a series of image performance tests, including Quality Assurance Procedure, are to be conducted. Door interlock, LED status lights, emergency stop, and x-ray alarm are also tested as part of this maintenance. Planned maintenance is to be performed annually by a factory trained Service Technician. If there are any questions regarding the annual maintenance, please contact CurveBeam Technical Support.

UPS (Uninterruptible Power Supply) Maintenance

Please refer to the Tripp Lite UPS (SMART1500LCDT 120v 1500va 900w and SMX1500LCDT 230V 1.5kVA 900W) User’s Guide for UPS maintenance recommendations.

Cyber Security Recommendations

CurveBeam uses commercially available software in the device that may be susceptible to unintended installation of malware or other malicious software that could compromise the full functionality of the device. Therefore, it is highly recommended that steps be taken to protect against possible vectors of infection. An industry standard, commercially available, active monitoring program such as anti-malware and antivirus program should be installed to protect the device against such attacks. Other protections such as strong security policies, access control policies, and strong network protection including the use of hardware and software firewalls are recommended in addition to active monitoring, in order to avoid infection or otherwise unintended consequences related to infection. It is important to protect the equipment from unauthorized access, unauthorized software, and insecure network access. Failure to sufficiently protect the equipment from possible attacks may result in unintended consequences including failure of the device.

Replacement Parts

Part Description	Part Number
Gantry Belt	200145-3
Lift Belt 1	200194
Lift Belt 2	200193
Lift Motor	100109-2
Rotation Motor	100109
Beam Limiter Motor	100112
Receptor Motor	100110
Knee Positioner Lift Column	2155-5
Breaker Switch Assembly 115VAC	4026-115-0
Breaker Switch Assembly 230VAC	4026-230-0
X-Ray Power Supply Assembly	4016-0
Embedded Board Assembly	4014-0
Can Bus Breakout Assembly	4006-0
120VAC Breakout Assembly	4017-0
LED Distribution Assembly	4008-0
X-Ray Tube head	2027-0
Image Receptor (Panel)	MX-CFP3131
Ethernet Cable CAT 6 GREEN, 50'	100105
Ethernet Cable CAT 6 RED, 50'	100106
Operator's Control Box	5006-0
Scan (Exposure) Switch	5007-0
Geometric Phantom	2803
QA Phantom	2802
Gantry Lift Controller	5221-0
Multi-Extremity Chair Motor Control Box	CO61
Multi-Extremity Chair Lift Column	DB-13
Multi-Extremity Chair Recline Motor	LA23
Multi-Extremity Chair Operator Controller	5222-0
Flat Platform Assembly	2100-72-0
Single Foot Platform	210-75-0
Knee Plate Assembly	2100-73-0
Hand Plate Assembly	2100-70-0
Hand Plate Assembly, Angled	2100-77-0
Ten Degree Foot Plate Assembly	2100-71-0
Knee Up/Down Control Assembly	5221-0

Accessories

Multi-Extremity Chair
 Patient Bench
 Stowaway Chair
 Hand and Elbow Positioner

System Dimensions

Scanner:

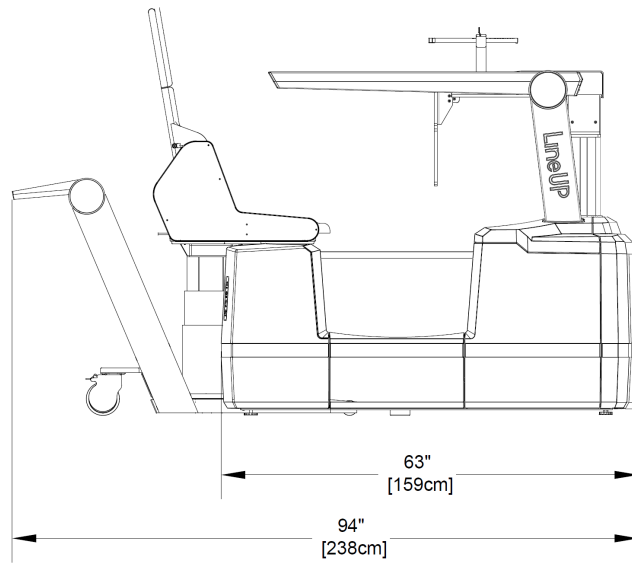
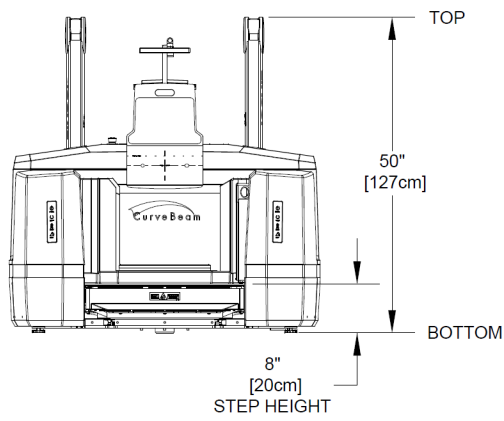
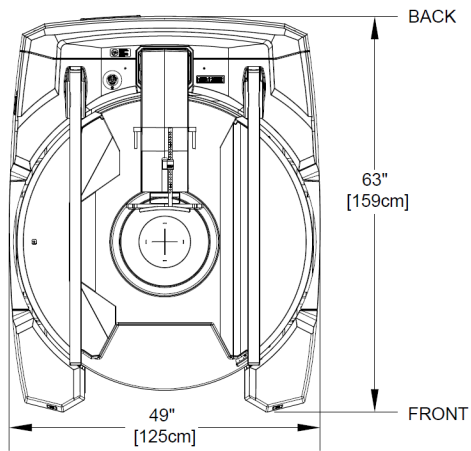

Multi-Extremity Chair:

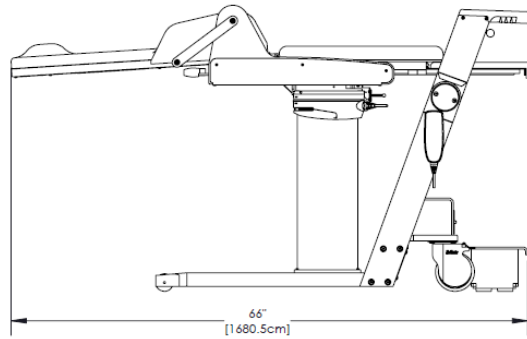
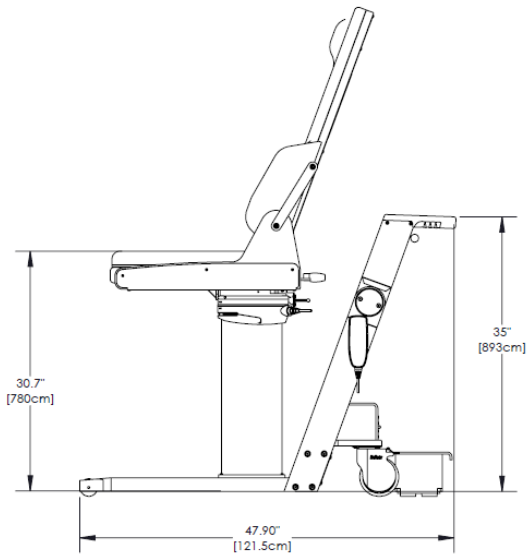
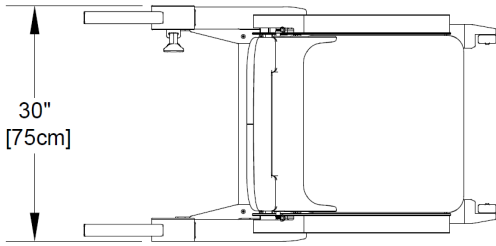

Patient Bench:

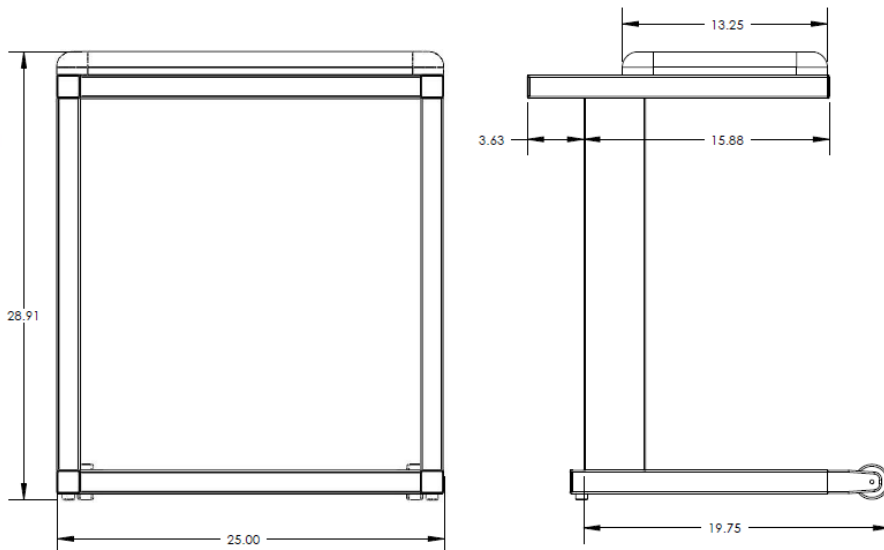

Stowaway Chair and Stowaway Bench:

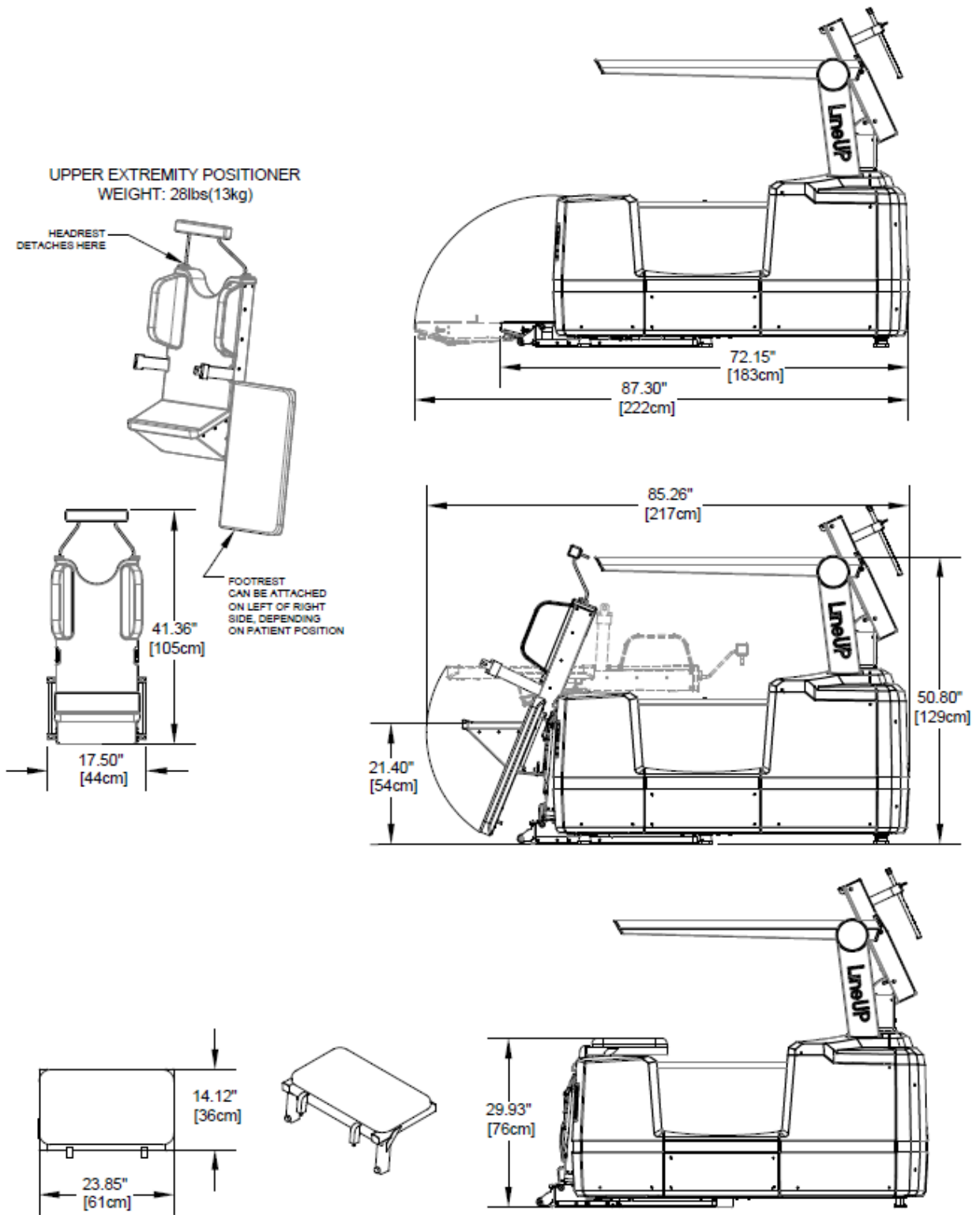

CHAPTER 3: Safety Items

In order to maintain the safety of patients and operators of this device, it is important to operate and maintain the system correctly, following all instructions, warnings, cautions in this manual and labeling on the system itself.

System Safety Devices

Emergency Stop: In the event of an emergency (any moving component collides with any parts of the equipment or items in the environment, or that could cause physical injury to the Patient), the Operator or Patient should utilize one of the 2 designated Emergency Stop (E-Stop) buttons to turn off the power to the X-ray and all moving parts in order for the Patient to be safely removed from the machine. There is an Operator E-stop button on the Operator Control Box and there is a Patient E-Stop button on the machine. The Emergency Stop (s) when activated will remove ALL power from the machine. If an E-Stop is activated, with a patient in the scanner, refer to the Emergency Removal of a Patient Section later in this chapter.

Moving Parts(over-travel): In the event of the use of either of the 2 designated Emergency Stop buttons or in any case where mains power is unintentionally interrupted, and the gantry is in motion, gantry shall stop within the limits defined below:

Gantry Rotational Movement	1 degree or less
Gantry Vertical Movement.	1cm or less

Warning System: The System is equipped with provisions for warning lights and/or audible alarms when X-ray power is energized. An externally powered Warning System can be connected to the cable provided which is capable of 250 volts, 50/60 hertz, and 1 amp. When X-ray power is energized the warning system is also energized.

Interlock System: This System is equipped with provisions for an Interlock Circuit which, when opened, will turn off X-ray power. This is a low voltage circuit, 5 volts DC. To use the Interlock Circuit, disconnect the factory installed Shorting Plug. Connect the supplied Interlock Cable to the scanner. Connect door switches (NO/COM terminals) and/or emergency stop switches (NC/COM terminals) in series between the other end of the Interlock Cable wires. Multiple door switches and/or emergency stop switches can be connected as long as the devices are connected in series. The entire circuit must be a closed loop when all of the doors are closed and/or emergency stop switches are in their normally closed state.

Whenever the door switch or switches are opened or emergency stop button(s) pressed the X-ray power will be turned off. X-ray power cannot be turned on when the interlock circuit is open.

Interlock and Warning System Schematic:

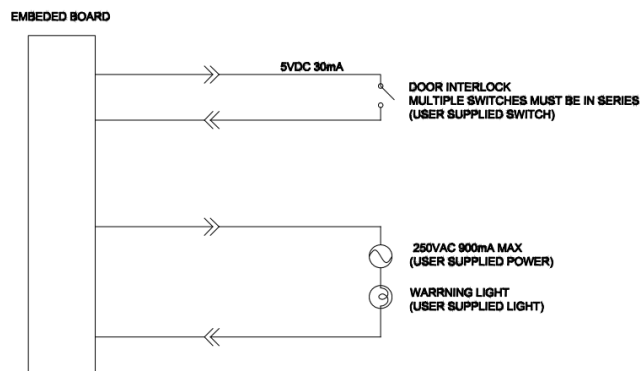

Emergency Removal of a Patient

The system has undergone extensive testing of the mechanical, electrical, and software performance, but if an unexpected occurrence is observed and/or the software locks up during a scan or an emergency arises where it becomes necessary to interrupt a scan and/or remove a patient from the system before a scan is completed, please follow these steps:

1. Press the EMERGENCY STOP button. This will halt the X-ray as well as the motors to the machine functions and all power to the machine. An error message will appear in the Acquisition software.
2. If the path into the machine is blocked by the gantry, manually rotate the gantry so that the patient entrance (side with the small step down) is at the front of the scanner.

If Multi-Extremity Chair and Patient Bench are NOT being used:

3. If the Gantry is raised, allow it to slowly lower, or assist the gantry down. If needed, press down on the small step the patient uses to enter and exit the machine.
4. Once the gantry is fully back to the starting position (gantry is down, step is at the front of the machine), carefully assist the patient to step out of the platform area.

If Patient Bench IS being used:

3. Instruct the patient to stand up and turn around to face the Patient Bench, then pull the Patient Bench out of the machine.
4. Carefully assist the patient to step out of the platform area.

If Multi-Extremity Stowaway Bench IS being used:

3. Instruct the patient to stand up and turn around to face the Patient Bench, then pull the Patient Bench out of the machine and store the Stowaway Frame under the scanner.

4. Assist the patient to step out of the platform area.

If Multi-Extremity Chair IS being used:

3. Instruct the patient to place their hands in their lap, unlock the wheel locks, and pull the Multi-Extremity Chair back out of the machine.
4. Assist the patient out of the Multi-Extremity Chair.

If Multi-Extremity Stowaway Chair IS being used:

3. Instruct the patient to place their hands in their lap, return the chair back to its initial position.
4. Assist the patient with the seatbelt and help them out of the Multi-Extremity Stowaway Chair.
5. Reset the machine: Close the Acquisition software (if not already). Release the E-stop by turning the knob to the right until it pops up. Then turn the machine power back ON at the Main Circuit Breaker. Re-launch the Acquisition software. Now the system can be operated again as expected.

In the case of loss of power to the scanner, perform Steps 1-4 above. Once power is restored, Step 5 can be performed.

Recommended Coverings

The follow table provides a reference to the recommended coverings.

Item	Manufacturer	Part number	Description	Certificates
Gloves - Clear Vinyl Powder Free Exam Gloves	AMMEX	VPF6X100 <i>The above "X" is dependent upon the size required.</i>	"dependable barrier protection against blood-borne pathogens and environmental contaminants " "Ambidextrous, FDA approved for all non-sterile medical procedures"	K891850
Barrier Film – Clear Film	Palmero Medical	1866C	"Polyethylene film with a low-tack adhesive that adheres to most operatory surfaces, leaves no residue, latex-free"	Safety Data Sheet provides Toxicology Information.
Exam Paper – Standard Crepe Exam Table Paper	MEDLINE	NON23325	"Strong, absorbent table paper helps protect exam tables from dirt and moisture while offering comfort and protection for patients."	Latex Free

Throughout the course of the manual, images of the device may be shown without the recommended coverings to provide a better visual for explanation purposes. It is recommended that these coverings be used at all times when using the LineUP device.

System Labels

Operator Control Box: E-Stop, Power ON light, X-ray Ready light, X-ray ON light, Fault light, Scan/Exposure Switch.

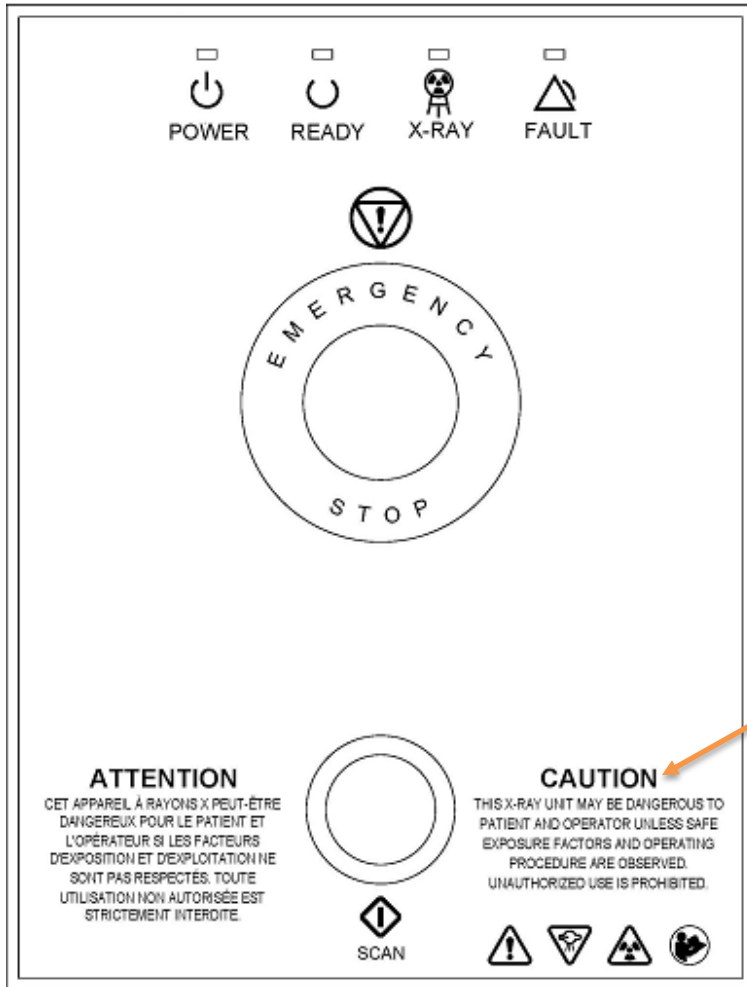

Zoomed in on the Verbiage:
CAUTION
THIS X-RAY UNIT MAY BE DANGEROUS TO PATIENT AND OPERATOR UNLESS SAFE EXPOSURE FACTORS AND OPERATING PROCEDURE ARE OBSERVED. UNAUTHORIZED USE IS PROHIBITED.

Rear Cover:

System Label location Voltage Nameplate location

CurveBeam
2800 BRONZE DRIVE
SUITE 110
HATFIELD, PA 19440
267-483-8081

Conforms To
AAMI STD ES60601-1
IEC STD 60601-1
IEC STD 60601-1-3
IEC STD 60601-1-6
IEC STD 62304
IEC STD 60601-2-44
IEC STD 60601-2-54
Certified To CSA STD C22.2 # 60601-1

CE 0413

ETL
C LISTED US
Intertek
4005156

Rx INTERMITTENT MODE OF OPERATION

MADE IN U.S.A.

5204_(REV)

Rear Connector Panel:

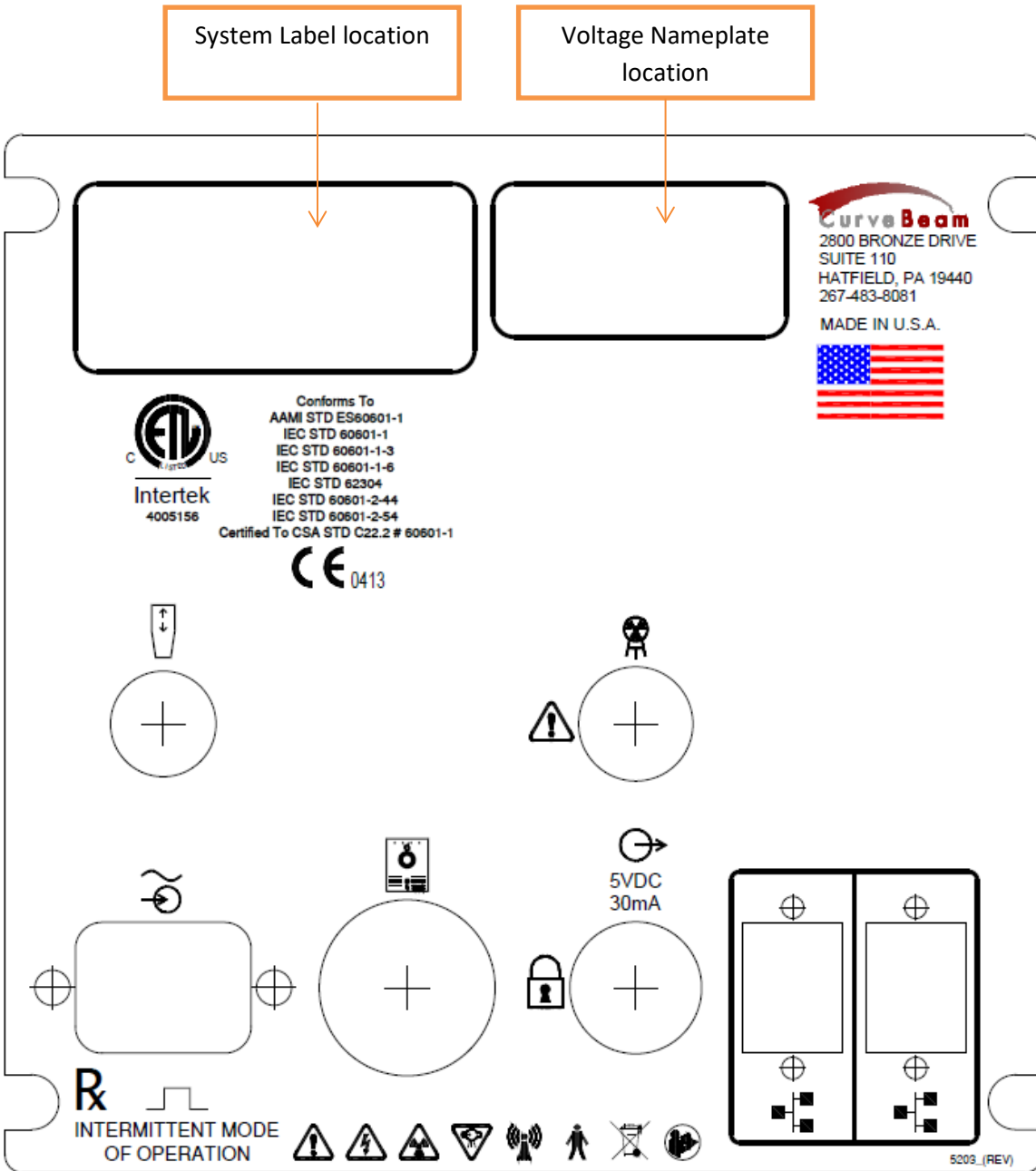

Voltage Nameplate for opening in Rear Connector Panel and Rear Panel:

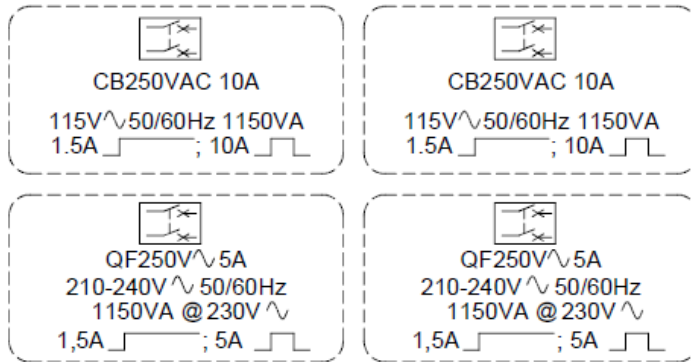

Fuse Label:

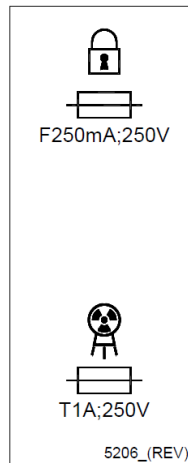

Patient Bench Label (for units equipped with Patient Bench):

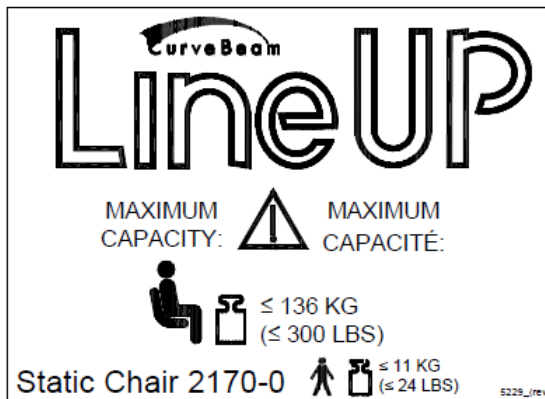

Indicator Panel (on machine):

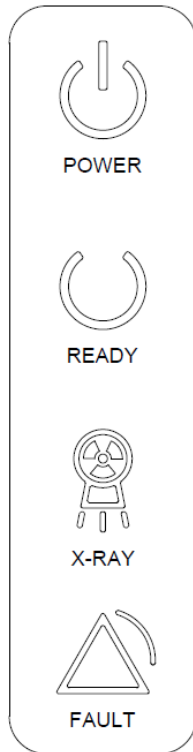

Multi-Extremity Chair label (for units equipped with the Multi-Extremity Chair):

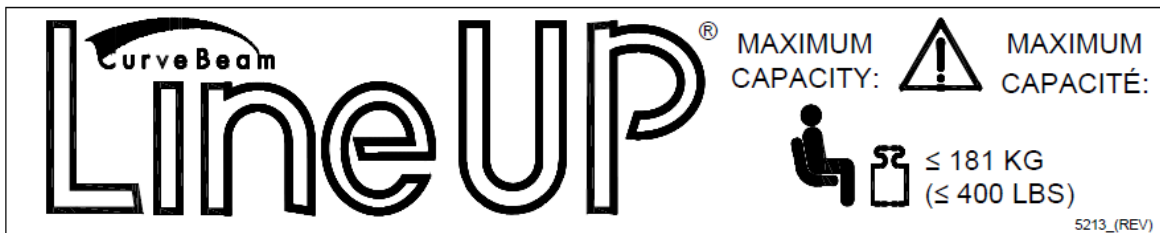

Handle Bar Label:

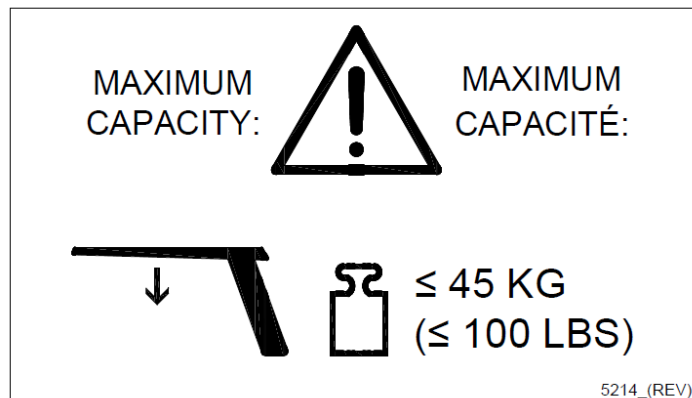

Knee Positioner / Gantry Height Adjustment:

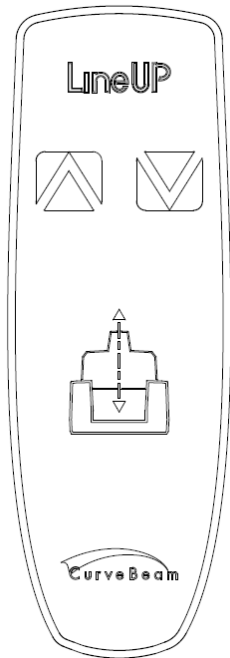

Multi-Extremity Chair Adjustment (for units equipped with the Multi-Extremity Chair):

For LineUP Serial Numbers
LU30001 and LU30002

For all other LineUP machines

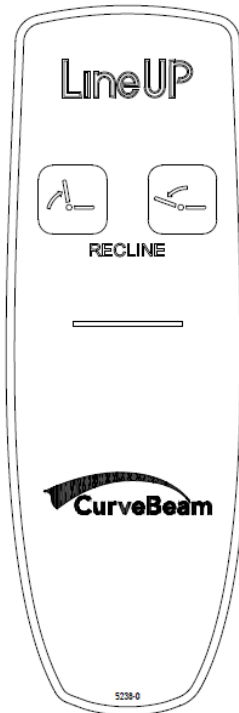
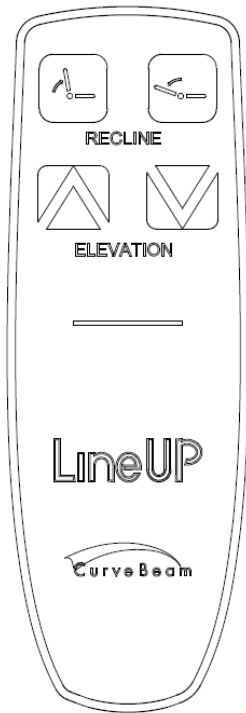

Multi-Extremity Stowaway Chair Adjustment (for units equipped with the Multi-Extremity Stowaway Chair):

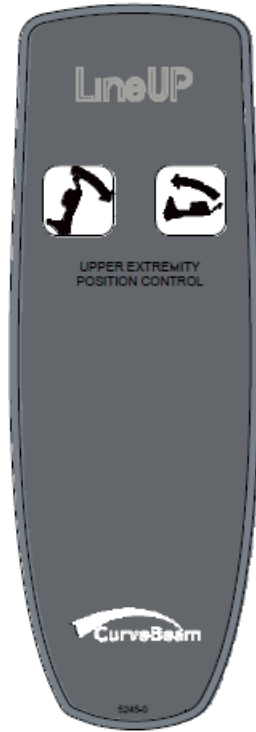

Lift Interrupt and Lift Enable Label (for units equipped with the Multi-Extremity Stowaway Chair):

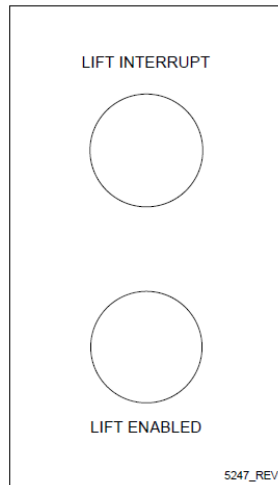

Multi-Extremity Stowaway Frame Label (for units equipped with the Multi-Extremity Stowaway Chair):



Multi-Extremity Stowaway Bench Label (for units equipped with the Multi-Extremity Stowaway Chair):

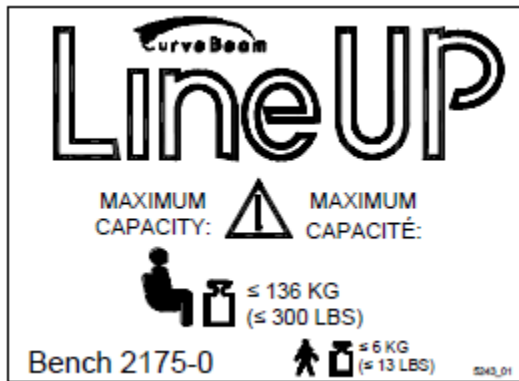

Multi-Extremity Stowaway Chair Label (for units equipped with the Multi-Extremity Stowaway Chair):

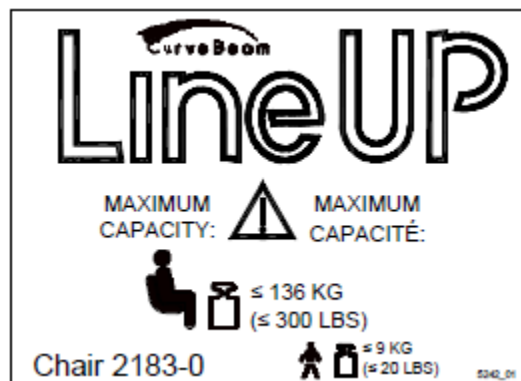

Cleaning Instructions Label on Scanner, Multi-Extremity Chair, and Multi-Extremity Stowaway Chair:

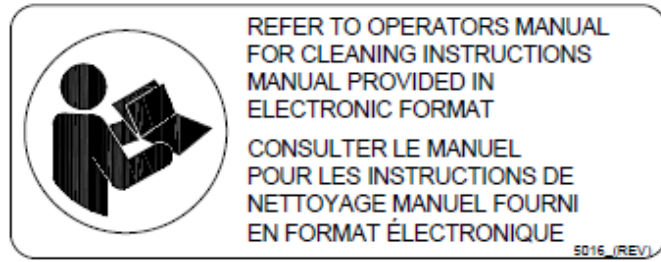

Pinch Point Label on Multi-Extremity Chair:

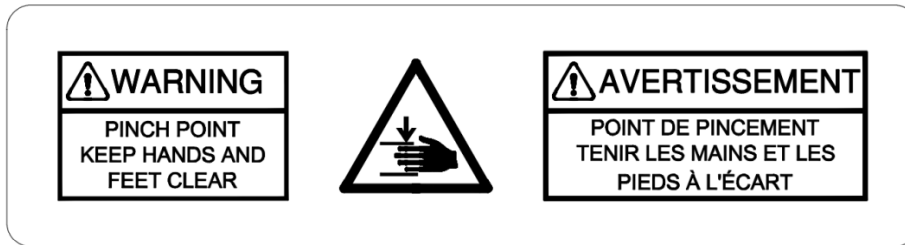

Pinch Point Label on Scanner:

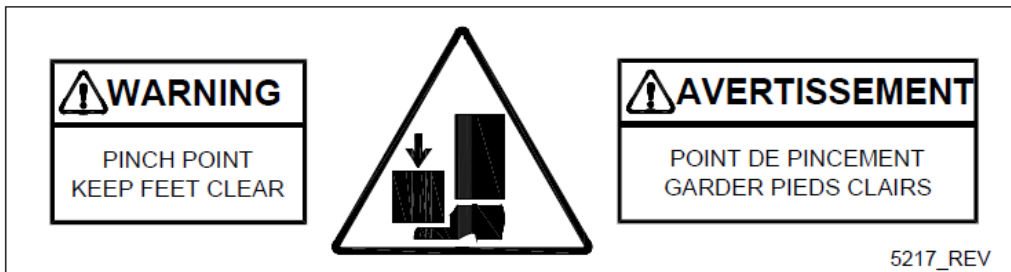

Multi-Extremity Chair Power (for units equipped with the Multi-Extremity Chair):

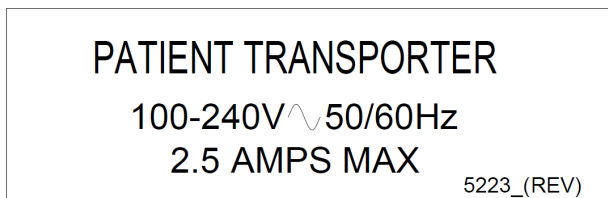

Power Switch:



Tubehead Focal Spot Label:

Focal Spot



5027_(REV)

Single Foot Platform:

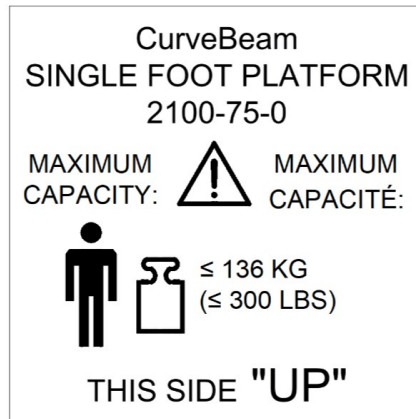

SINGLE FOOT PLATFORM LABEL
5232

System Label:



Depending on description, the following may be in this field:

- LineUP
- X-Ray Power Supply
- Beam Limiter
- Control Box

CurveBeam LLC.

This product complies with DHHS standards under the Radiation Control Act of 1968 applicable at date of manufacture. This product complies with 21 CFR 1020.30 – 1020.31

(see description on left)

 (YYYY-MM)		(01)XXXXXXXXXX
 (Model No)	<div style="border: 1px solid black; width: 80px; height: 50px; margin: 0 auto;"></div>	(21)XXXXXX
 (Serial No)		







Manufactured by CurveBeam LLC.
2800 Bronze Dr. Hatfield, PA 19440 USA

5008_(REV)

Tube Head Label:

CurveBeam LLC.



























This product complies with DHHS standards under the Radiation Control Act of 1968 applicable at date of manufacture. This product complies with 21 CFR 1020.30 – 1020.31

 Tube Head Assembly (YYYY-MM)  20XX-0  (Serial No)	 X-Ray Tube Superior x-Ray  SXR-130-20-0.5  (Serial No)
---	--

120kVp, 5mA  10.5mm Al, fs 0.5mm

Manufactured by CurveBeam LLC.
2800 Bronze Dr. Hatfield, PA 19440 USA

5008_(REV)

SYMBOLS:			
 General Warning	 Ionizing Radiation	 Electrical Hazard	 AC In
 Emergency Stop	 X-Ray Radiation	 Non-Ionizing Radiation	 Network Cable
 Power	 Follow Operating Instructions for use.	 Type B (body) applied part complies with IEC 60601-1	 Control Box
 Ready	 Scan	 Recycle	 Pinch Point
 X-Ray On	 Interlock	 Output for Interlock 5VDC 30mA	 Maximum weight capacity for sitting.
 Fault	 Pinch Point - Feet	 Maximum Weight capacity for standing.	 Maximum weight capacity for handle bars.
 Fuse T1A250V, T=time delay, 1amp, 250volt fuse F250mA250V, F=fast acting, 250mA, 250volt fuse	I Power/Circuit ON O Power/Circuit OFF	<p>CE Mark</p>  class IIb	
		<p>This product carries the CE Mark. The CE Declaration (CE Conformity) becomes invalid if the product is changed without explicit consent of the manufacturer! This applies to all parts, not only to safety elements.</p>	

European Authorized Representative:	CurveBeam Europe Limited Devonshire House 1 Devonshire Street London W1W 5DR
--	---

System Controls and Indicators

Operator Control Box:

The Operator Control Box contains the status indicator lights as well as the Emergency Stop button and the Exposure Control Switch. This can sit on a table or be mounted on a wall. It is equipped with a 50-foot cable.

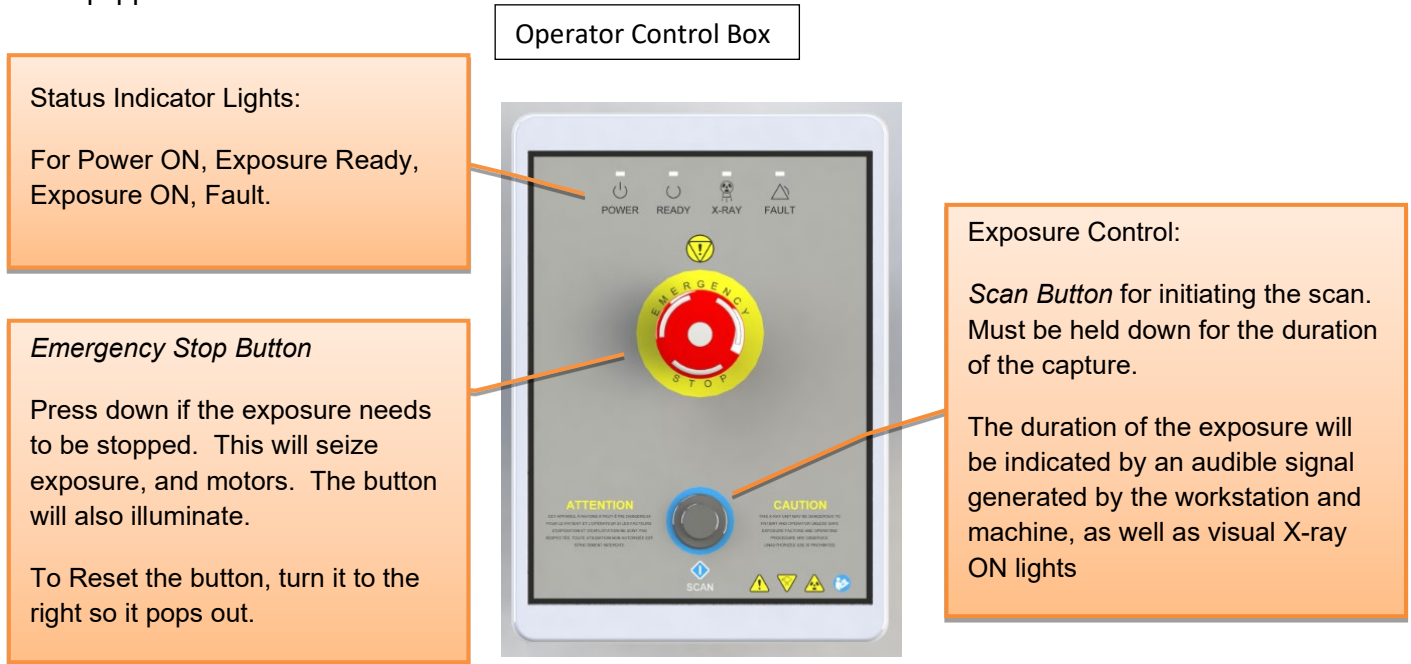





Patient Emergency Stop Button:

This Emergency stop button is intended for the patient to stop exposure during a scan. This will seize exposure and all motors. It is located on the machine itself. To Reset the button, turn it to the right so it pops out.

System Status Indicators

There are 4 indicator lights. These indicator lights are on the Operator's control box and on the machine itself on the upper right cover. There are also similar indicators within the Acquisition software program.

The lights are as follows:

-  **Power ON:** This is solid **Green** when the machine is ON.
-  **Ready:** This is the Exposure Ready light and is **Green** when the machine is in Ready state for exposing. This would indicate that it is time to press the exposure button.
-  **X-Ray ON:** This is an **Amber** color when the system is exposing, emitting X-ray.
-  **Fault:** This would be **Red** in color if there was a failure in the system.

Status Indicator panel on machine: *front right and left cover*

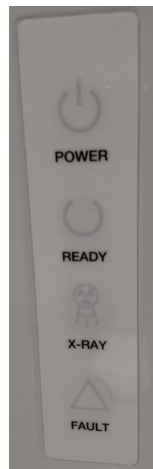

CHAPTER 4: Calibration and Quality Assurance (QA) Procedures

Calibration Procedures

Calibrations are necessary for proper performance of the LineUP. A Panel Calibration needs to be performed by a CurveBeam Technical Support specialist annually. The user can request a calibration at the scheduled interval by contacting CurveBeam Technical Support to assist with the calibration.

 **WARNING** Prior to performing any calibrations, ensure the machine is not in use, and patient is not in the scanner.

Quality Assurance Procedures

The Quality Assurance (QA) procedures are designed to check for Image Quality, Accuracy of Distance Measurements, Consistency, and Uniformity. These procedures can be performed by a LineUP owner/operator, or any service technician or radiation physicists. It is recommended that this QA procedure be performed quarterly or if there are any indications of image quality or accuracy issues.

The Quality Assurance Procedures are comprised of the following:

- Image Quality Assessment, which includes:
 - High Contrast Spatial Resolution (Line Pair measurement)
 - Hounsfield Units accuracy of 5 density chambers
- Distance Measurement Accuracy
- Consistency and Uniformity, which includes:
 - Noise Level Test
 - Uniformity Test

The QA Procedures will be performed by scanning the Unified QA phantom provided by CurveBeam. This Unified QA Phantom is comprised of QA Line Pair/Materials section and a simulated water section. Image Data will be captured and assessed for acceptable values.

The Unified QA Phantom is shown, positioned in the scanner, here:

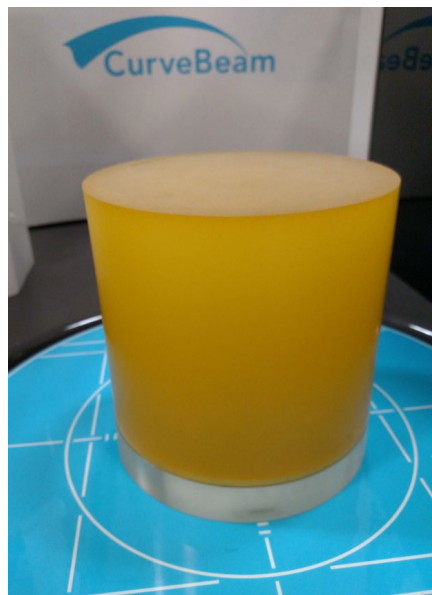

⚠ WARNING Prior to performing any quality assurance procedures, ensure the machine is not in use, and patient is not in the scanner.

To perform the Quality Assurance Procedures, the following steps will need to be performed twice. The first time on a Medium Field of View (MFOV) scan and the second on a Large Field of View (LFOV) scan. The scans to be performed are specified in the instructions which follow. All steps are identical for MFOV and LFOV scans, except for the High Contrast Spatial Resolution (Line Pairs) expected from MFOV and LFOV scans. The difference is noted in the instructions as the appropriate step.

1. Place the Unified QA Phantom on the patient platform in the center of the device, using the circular positioning guides to center it on the platform. The line pair section should form a long horizontal line that goes from left to right. The simulated water should go on top of the line pair section. Simulated water is removed in the image below to show alignment and positioning.

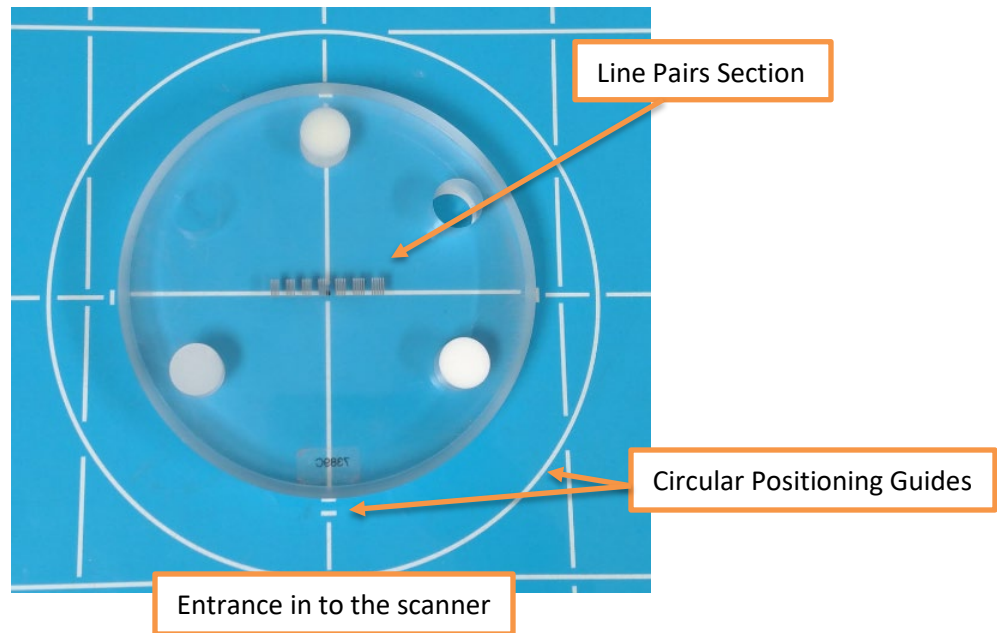

Ensure that the entire Unified QA Phantom, both the QA Line Pair/Materials section and a simulated water section, is placed on the patient platform as show below:

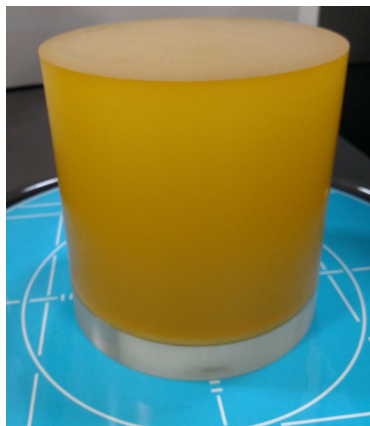

2. Acquire a CBCT scan of the phantom using a **Medium Field (120 kVp) Foot scan**.



Advice: Please refer to the Acquiring a Scan section of the manual, Chapter 6, for Acquiring the scan).



WARNING The X-ray device may be dangerous to the Patient and Operator if you do not observe and follow operating instructions. Do not operate this system unless you have received training to perform a procedure

3. Open the newly captured scan in CubeVue, or another DICOM Viewing software, and load the acquired scan to perform all of the QA Procedures.
4. Apply the Sharp Filter on the image in the DICOM viewing software– keep this set for all of the remaining QA procedures.
5. Change the slab thickness to the smallest thickness in the axial window – keep this set for all of the remaining QA procedures.
6. *Evaluate High Contrast Spatial Resolution (Line Pairs):*
 - a. Center the Line Pairs in the axial window. This can be done by using the coronal and sagittal views to approximate the center of the line pairs (height), then view in the axial window.
 - b. Observing the line pairs in the DICOM Viewer's axial view, determine how many line pairs can be seen accurately, where lines can be distinguished as lines. The line pairs start at 10 line pairs (easiest to distinguish these line pairs), the second set of line pairs is 11 line pairs per cm, third set is 12 line pairs per cm, and so forth. The expected result should be 12 line pairs per cm or better.
 - c. Visually verify that there is definition present for each of the lines in line pair 12, or higher, for a MFOV scan. For a LFOV scan, 10 line pairs per cm, or higher, should be visible.

7. Evaluate Hounsfield (HU) Accuracy of Density Chambers (HU of 5 Materials & Background Material):

- a. Remain on the same Axial slice as in the last step where the Line Pairs are visible. If using CubeVue, in the Measurement section, select HU and then “QA unified” to provide six small HU circles. The positioning of the HU circles may not be exact and they may require slight adjustment to align them over the 5 materials, plus the background material. If using another DICOM viewer, select HU circles that are within the materials, with an approximate area of 141mm². The image below shows the QA unified circles from CubeVue placed over the 5 materials and the background material.

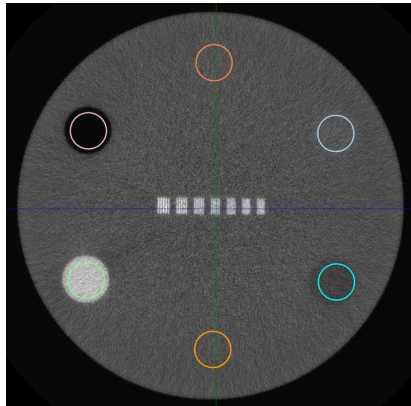

- b. Measure the Hounsfield Units value of each density chamber.



Advice: *Keep the HU circle off the borders of the chambers.*

The results should fall within the below ranges.



Advice: Nylon can be difficult to see, it is positioned between the Acrylic and Air chambers. The values in the table do go in order (either clockwise or counter clockwise) around the materials. If the value is not in range, check to ensure the correct material is selected.

Density Material	Expected HU value Ranges
AIR (black chamber):	-1100 to -900
TEFLON (white chamber):	700 to 1200
Background Material:	-50 to 150
LDPE (dark gray chamber):	-250 to -50
ACRYLIC (light gray chamber):	-50 to 200
NYLON (lightest gray chamber):	0 to 200

8. Evaluate Distance Measurement Accuracy (diameter measure of phantom):

- a. Remain on the same Axial slice as in the last step where the Line Pairs are visible. Make a distance measurement of the diameter of the Unified QA Phantom, using the Distance Tool, from one edge of the phantom to the other edge. It is best to go through the center of the line pair, to ensure a true diameter measure. The diameter of the Unified QA Phantom should be between 149.9 – 151.1 mm.

9. Noise Level Test (HU water, center):

- a. In the currently open Unified QA Phantom scan, navigate to the center of simulated water in either the Coronal or Sagittal View. Then view the center slice in the Axial View.
- b. If using CubeVue, in the Measurement section, select HU and then “QA set large” to provide large HU circles, which can be moved to the desired location. CubeVue will provide 5 HU circles, the center circle is used for this test, the other circles will be used in the next QA procedure. If using another DICOM viewer, select HU circles that create an area of about 600mm² to measure the HU value. And place the HU circle in the center of the simulated water.
- c. The mean measurement value, at the center of the simulated water, should be in the range of:

Water: -150HU to 150HU

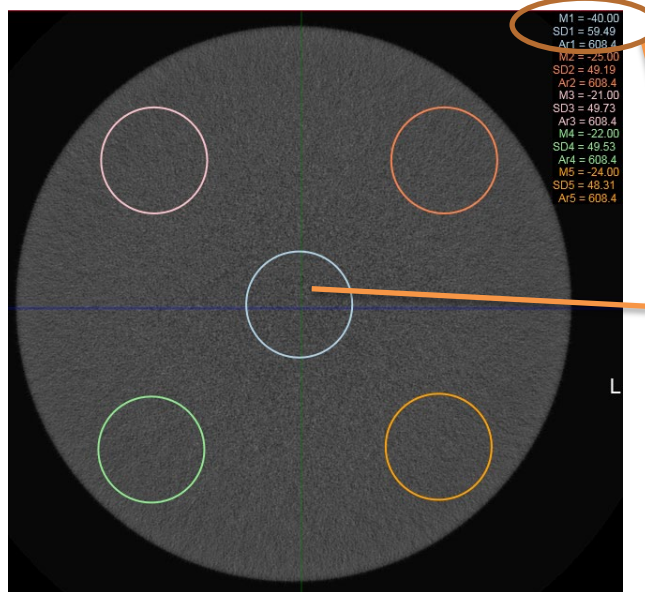

In CubeVue HU QA set large selected. Note the blue center circle and corresponding blue mean value (M1 in this example)

10. Uniformity Test (HU water 4 quadrants):

- a. Still on the same Axial slice, in the center of the simulated water, if not using CubeVue, make 4 additional HU circles of similar size to the one made for the center circle (approximate area of 600mm²). If using CubeVue, all circles are already available.
- b. Ensure that the center HU circle is still in the center, and then move the other 4 HU circles so that one is in each quadrant, near the edge, but not too close, as shown below:

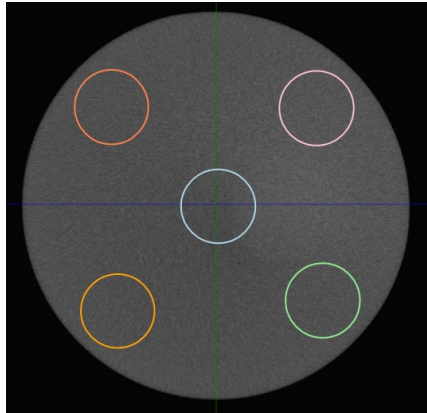

- c. Compare the mean HU value (provided by HU tool) of each of the 4 quadrants with the center mean HU value. The mean HU of each of the 4 circles should be within 250HU of the mean HU value measured from the center circle.

11. Repeat Steps 1-10 using a **Large Field (120kVp) Foot Scan**.

Radiation Output Test

It is recommended that a check of the kVp(eff) and Radiation Output of the X-ray source be performed annually by a qualified Physicist. The incident Absorbed Dose at the detector may be measured using a dosimeter. Tests are performed to assess output value and to check for tube output consistency and timer accuracy.

 **WARNING** Prior to performing any radiation output testing, ensure the machine is not in use, and patient is not in the scanner.

1. Attach a dosimeter to the detector such that the sensor is positioned where the vertical and lower horizontal laser lights intersect.
2. Perform a Standard scan of 20 cm diameter x 20 cm height, 0.3 voxel (Procedure Name: Medium Field (120kVp)) and record the time and dose from the meter.

 **WARNING** The X-ray device may be dangerous to the Patient and Operator if you do not observe and follow operating instructions. Do not operate this system unless you have received training to perform a procedure

3. Perform a Standard scan of 20 cm diameter x 20 cm height, 0.3 voxel (Procedure Name: Medium Field (100kVp)) and record the time and dose from the meter.

 **WARNING** The X-ray device may be dangerous to the Patient and Operator if you do not observe and follow operating instructions. Do not operate this system unless you have received training to perform a procedure

CHAPTER 5: Radiation Environment Survey

Scatter Measurements

Methodology

The Scatter measurements were taken using a RadCal 10X60-180 Leakage and low measurements Ion Chamber (serial: 08-0455) last calibrated 08/16/2019. Each measurement was made using a single rotation scan in the foot position at 120 kVp\5 ma. This type of scan is considered the highest output the scanner can produce.

The Ion Chamber was placed at different heights along the Z axis and different positions along the X and Y axis while the scan was run. Each measurement is made at an increment of .5 meters from the iso center. A CTDI PMMA 32 cm phantom was placed in the FOV during each scan. The measurements were recorded on the table below.

		120 kvp, 5ma						
Y axis = 0.0 m		Left to right (x direction) uR						
		-1.5m	-1.0m	-0.5m	0.0m(uR)	0.5m	1.0m	1.5m
Z-Axis	1.5m	Same as Right Side (uniform shielding)	368.9	387.3	342.50	360.53	360.08	256.20
	1.0m		671	566.45	1087.53	665.65	710.57	314.35
	0.5m		709.2	2196.03	3884.50	2698.85	843.52	123.03
	0.0m		109.4	N/A (inside machine)			117.66864	50.431046
	-0.5m	Measurements at this distance not possible with this device						
-1.0m								
-1.5m								
X-Axis = 0.0m		front to back(y direction)						
		-1.5m	-1.0m	-0.5m	0.0m(uR)	0.5m	1.0m	1.5m
Z-Axis	1.5m	125.76	201.82	264.64	342.50	174.22	378.77	265.21
	1.0m	81.41	671.00	575.57	1184.67	897.91	757.89	333.85
	0.5m	34.72	80.44	2237.07	3962.20	2079.72	251.30	135.91
	0.0m	19.14	25.10	N/A(inside machine)			100.82	55.07
	-0.5m	Measurements at this distance not possible with this device						
-1.0m								
-1.5m								

		Left to right (x direction) uGy/mAs						
Y axis = 0.0 m		-1.5m	-1.0m	-0.5m	0.0m	0.5m	1.0m	1.5m
Z-Axis	1.5m	Same as Right Side (uniform shielding)	368.9	387.3	342.50	367.83	382.31	290.07
	1.0m		671	495.53	1087.53	708.06	737.82	342.17
	0.5m		709.2	2158.40	3884.50	2363.63	987.87	283.45
	0.0m		109.4	N/A (inside machine)			103.393336	37.91165
	-0.5m	Measurements at this distance not possible with this device						
-1.0m								
-1.5m								
X-Axis = 0.0m		front to back(y direction)						
		-1.5m	-1.0m	-0.5m	0.0m	0.5m	1.0m	1.5m
Z-Axis	1.5m	166.70	227.58	334.53	342.50	449.47	396.90	296.34
	1.0m	112.08	671.00	552.43	1278.16	907.60	683.55	381.51
	0.5m	56.18	130.10	2200.59	4046.57	2218.83	823.79	295.88
	0.0m	19.39	29.47	N/A(inside machine)			89.55	47.95
	-0.5m	Measurements at this distance not possible with this device						
-1.0m								
-1.5m								

Cone Beam CT Performance Testing for FDA Submission – CurveBeam LineUP 12/18/17 (Rev. 2/23/18)

The following protocol were tested for dose measurements and several image quality tests:

kVp	mA	Pulse Duration (seconds)	Number of Pulses per Scan	mAS	Slice Thickness (mm)	Number of Slices	Scan Diameter (cm)
100	5	0.012	480	43.2	0.3	690	36.143
120	5	0.012	480	43.2	0.3	690	36.143

This was done for two tube positions, the x-ray tube head up position and the x-ray tube head down position.

CTDI Measurements

Please refer to Appendix II for CTDI values for all protocols.

CTDIVol Methodology

CTDIVol measurements were made using the Rad Cal 10x6-3ct CTDI 100 mm pencil ion chamber (serial: 05-1454) last calibrated 03/24/2020. Measurements were taken using the CTDI PMMA 16cm or 32 cm Phantom depending on the intended use of the scan type. Scans were completing using a single rotation of the device. Separate measurements were taken with the pencil ion chamber in the center of the phantom and the 4 outside positions while keeping the phantom in the center of the scanners FOV. The CTDIVol was then calculated using the formula ($1/3 * \text{center measurement} + 2/3 * \text{average of four quadrants}$), results are displayed in the table below.

Phantom	DB 100	DB 120	DC 100	DC 120	UA 100	UA 120	UC 100	UC120
16 cm 0°			2.15	3.613			1.436	2.446
16 cm 90°			2.125	3.552			1.417	2.407
16 cm 180°			2.108	3.52			1.418	2.39
16 cm 270°			2.137	3.584			1.433	2.44
16 cm Center			1.847	3.161			1.237	2.122
32 cm 0°	1.18	2.027			1.082	1.844		
32 cm 90°	1.156	1.98			1.089	1.829		
32 cm 180°	1.144	1.939			1.064	1.784		
32 cm 270°	1.162	1.978			1.089	1.862		
32 cm Center	0.5045	0.9242			0.4872	0.8715		
CTDI Vol	0.941833333	1.628733333	2.035666667	3.431833333	0.883066667	1.510333333	1.363	2.321166667
Average Peripheral	1.1605	1.981	2.13	3.56725	1.081	1.82975	1.426	2.42075
Peripheral Normalized	0.585815245	1	1.075214538	1.800731954	0.545683998	0.923649672	0.719838465	1.221983847
Centere Normalized	0.545877516	1	1.998485176	3.420255356	0.527158624	0.94297771	1.33845488	2.296039818

Phantom Details:

- This CTDI phantom meets the provisions of 21 CFR 1020.33 and has passed a comprehensive quality assurance test by a qualified medical physicist.
- Diameter 16cm
- Height(L) 14.11cm
- Density 1.18g/cm³

Dose Profile

Methodology

The dose profile was measured by exposing strips of GAF chromic film, which was aligned at the isocenter of the scanner. The film was then digitized and the profile was measured. This was done for two tube positions, the x-ray tube head up position and the x-ray tube head down position. A nominal beam width of 21.521 is used for the x-ray tube head up position, and 21.342 cm is used for the x-ray tube head down position. The full width at half maximum was determined.

Results – X-ray tube head up

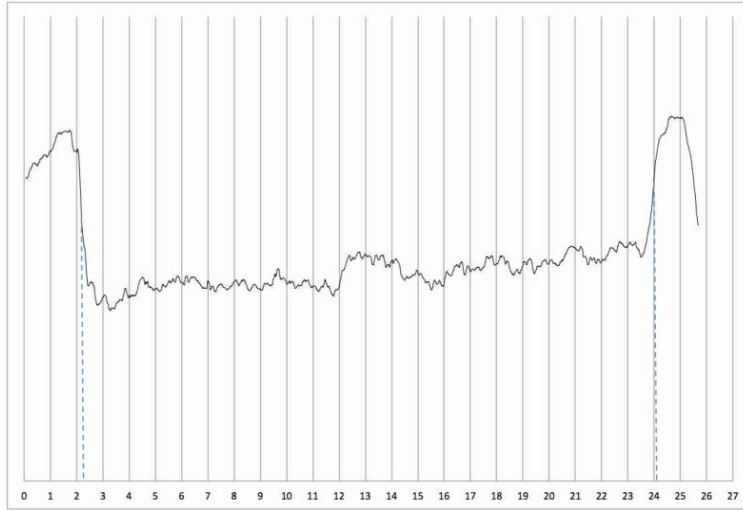

Dose Profile (FWHM) (cm)	21.9
-------------------------------------	-------------

Results – X-ray tube head down

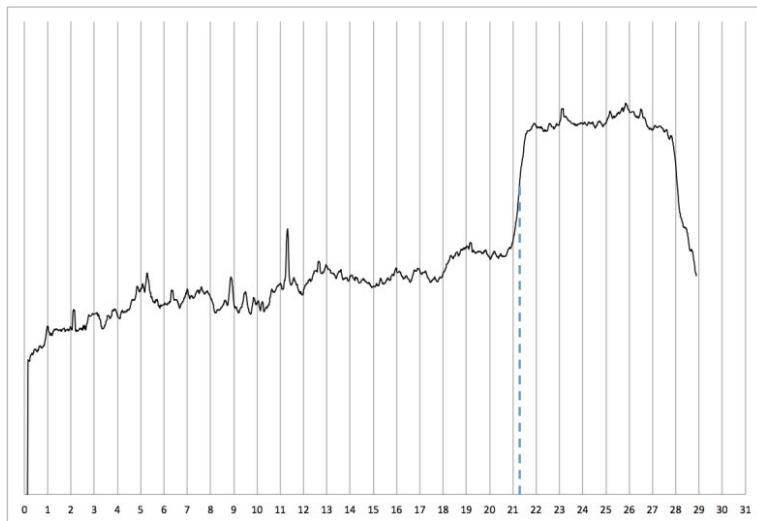

Dose Profile (FWHM) (cm)	21.2
-------------------------------------	-------------

Modulation Transfer Function (MTF)

Methodology

Using the manufacturer's Quality Control Phantom, a series of high contrast line pairs were scanned. The profile of each line pair group was plotted, the average peak pixel value and the average low pixel value were compared to the pixel value of the bar material and the background. As the spatial frequency increases the amplitude of the signal (peak to trough pixel values) drops, relative to the bar material and background, yielding the MTF. The MTFs for each scan type are plotted and shown with the 0.10 MTF being reported in the table in Mm. This approach is in alignment with the approach proposed in GJB 5312-2004. The 120 kVp technique was used in the x-ray tube head up position and 100 kVp was used in the x-ray tube head down positions.

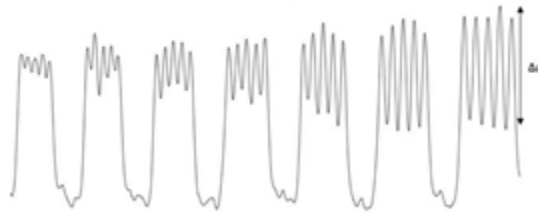

$$pMTF \text{ line pair } (i) = \frac{\Delta\mu(i)}{\Delta\mu}$$

Results

X-ray tube head down:

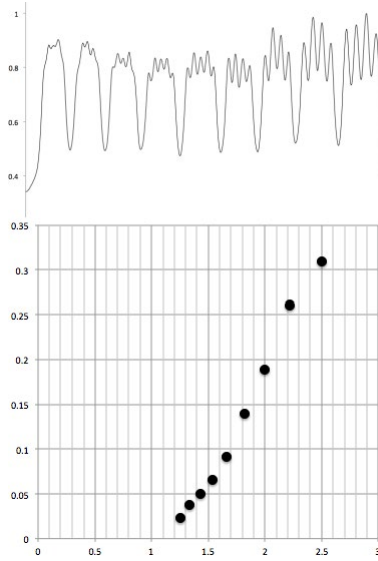

Limiting Resolution (MTF < 0.1)	
Line Pair per mm (lp/cm)	12
mm	1.67

X-ray tube head up:

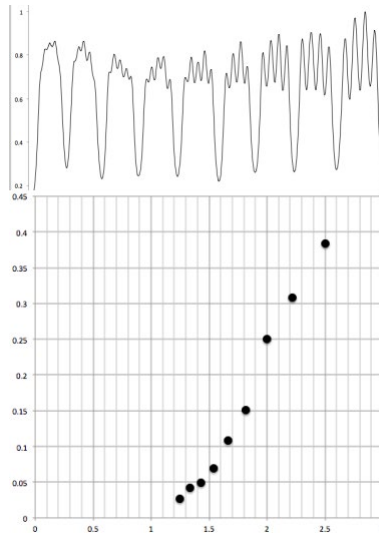

Limiting Resolution (MTF < 0.1)	
Line Pair per mm (lp/cm)	13
mm	1.54

Uniformity

Methodology

Uniformity was determined in the water-equivalent phantom. One center region of interest (ROI) is compared to 4 peripheral ROIs. Limits are determined by the manufacturer.

Results

X-ray tube head down

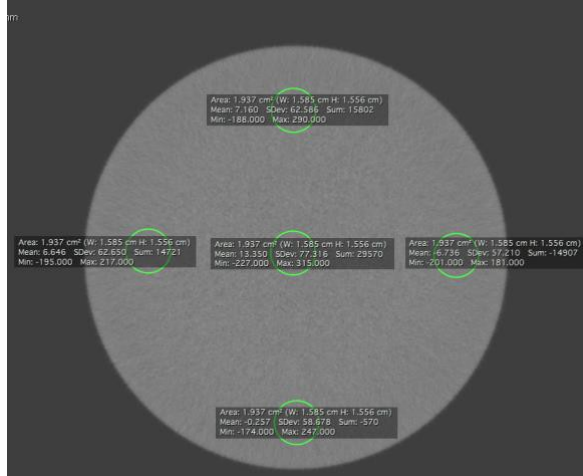

X-ray tube head up

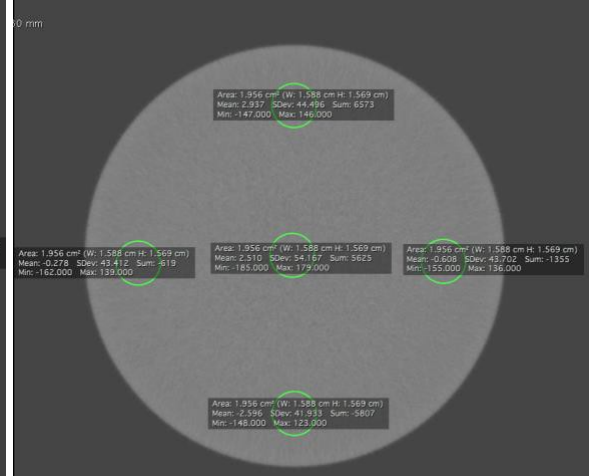

Protocol	Maximum Center-Peripheral Deviation	Limit (set by manufacturer)
X-ray tube head down	13.612	<100
X-ray tube head up	5.106	<100

CT Number Accuracy

Methodology

CT number accuracy was tested for this unit using the manufacturer’s quality control phantom, which includes cylinders of 4 different materials – Teflon, acrylic, air, and low density polyethylene. LDPE. Small ROIs were used to measure the CT numbers in these test materials. These values were then compared to the expected values.

Results

Protocol	Material	Measured CT Number	Expected Value
X-ray tube head down	Teflon	1091.86	850 ±250
	Acrylic	130.847	75 ±125
	Water	13.355	0 ±150
	LDPE	-108.815	-150 ±100
	Air	-1016.376	-1000 ±200
X-ray tube head up	Teflon	848.106	850 ±250
	Acrylic	100.636	75 ±125
	Water	2.510	0 ±150
	LDPE	-99.087	-150 ±100
	Air	-898.855	-1000 ±200

Tomographic Slice Accuracy

Methodology

Slice thickness accuracy was tested using the resolution test pattern in the QC phantom. The thickness of this test pattern is 0.08” (2.032 mm) according to the phantom’s manufacturer. The CT number of the test pattern was evaluated at a number of slices, and the full-width at half maximum (FWHM) was evaluated. The expected slice thickness is 0.3 mm.

Results

As shown in the plot below, the FWHM was determined to be 6.507 pixels. 6.507 pixels would need to be 0.31 mm thick to result in the correct pattern thickness. This is well within the range of 0.2 – 0.4 mm.

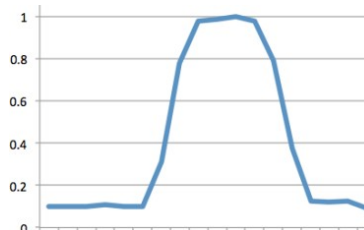

2-D Imaging Mode

This scanner also has a 2-D imaging mode for single shot radiographic images. This mode operates only at 60 kVp through a range of mAs. The tube current is always set at 5 mA.

Reproducibility

Methodology

Ten shots were taken at 60 kVp and 5 mAs (5 mA, 1000 msec) to determine the reproducibility of the kVp, exposure, and exposure time. A source to detector distance of 76.11 cm was used.

Results

	Energy (kVp)	Exposure (mR)	Time (msec)
	60.07	1.8	999.0
	60.37	1.8	998.7
	60.64	1.8	999.1
	61.53	1.9	998.4
	60.07	1.8	999.2
	61.30	1.9	999.4
	61.11	1.8	999.3
	60.41	1.8	999.3
	62.26	1.9	999.1
	61.36	1.9	999.0
Mean Value	60.91	1.8	999.1
Standard Deviation	0.72	0.01	0.30
COV	0.0118	0.0048	0.0003

Half value layer

Methodology

The half value layer measurement determines a parameter known as "beam quality", which is an indication of the energy spectrum of the X-ray beam and will generally affect both image quality and patient dose. Improper filtration of the X-ray beam can lead to a failure of this test as can inaccurate voltage calibration.

Results

Nominal (Selected) kVp	Minimum Half Value Layer (mm Al)	Measured HVL
60	2.2	5.28 mm Al

Exposure-mAs Linearity

Methodology

The mA/mAs linearity test assesses the unit's linearity over the range of these parameters available on the generator and using all available focal spot sizes. Measurements are performed at a fixed kVp setting and an mR/mAs value is calculated for each exposure. No two adjacent mR/mAs values may differ by more than 0.1 times their sum. The estimated coefficient of variation of the measured output should be no greater than 0.05. This system was tested at 60 kVp.

Results

mAs	Focal Spot Size	Nominal mAs	Displayed Exposure Time (msec)	Measured Exposure Time (msec)	Measured Exposure (mR)	mR/mAs
6.5	Large	6.5	1300.0	1299	2.379	0.37
6	Large	6.0	1200.0	1199	2.204	0.37
5	Large	5.0	1000.0	999.0	1.853	0.37
4	Large	4.0	800.0	799.2	1.398	0.35
3.75	Large	3.8	750.0	749.3	1.375	0.37
3	Large	3.0	600.0	599.0	1.103	0.37
2.5	Large	2.5	500.0	499.2	0.875	0.35
2	Large	2.0	400.0	399.1	0.741	0.37
1.5	Large	1.5	300.0	299.3	0.548	0.37
0.75	Large	0.8	150.0	149.6	0.271	0.36

Coefficient of Variation	0.021
---------------------------------	--------------

Timer Accuracy

Methodology

The accuracy of the unit's timer circuit is determined by taking a number of exposures at different timer settings and comparing actual versus indicated exposure lengths. In general, specifications for timer accuracy are set by the equipment manufacturer, but in no case should the percent difference between indicated and actual time be greater than 10% (or 1 pulse for single-phase units, whichever is greater).

Results

Indicated Time (msec)	Measured Time (msec)	Difference (msec)	Percent Difference
1300.0	1299.0	1.0	0.1%
1200.0	1199.0	1.0	0.1%
1000.0	999.0	1.0	0.1%
800.0	799.2	0.8	0.1%
750.0	749.3	0.7	0.1%
600.0	599.0	1.0	0.2%
500.0	499.2	0.8	0.2%
400.0	399.1	0.9	0.2%
300.0	299.3	0.7	0.2%
150.0	149.6	0.4	0.3%

Modulation Transfer Function (MTF)

Methodology

Using a Type 18 Test Phantom, a series of high contrast line pairs were scanned. The profile of each line pair group was plotted, the average peak pixel value and the average low pixel value were compared to the pixel value of the bar material and the background. As the spatial frequency increases the amplitude of the signal (peak to trough pixel values) drops, relative to the bar material and background, yielding the MTF. The MTFs for each scan type are plotted and shown with the 0.10 MTF being reported in the table in Mm. This approach is in alignment with the approach proposed in GJB 5312-2004. The 60 kVp, 6.5 mAs technique was used in the x-ray tube-up position. The 60 kVp 4.0 mAs technique was used for the x-ray tube down position. The tube down position was tested on a later date, February 9, 2018.

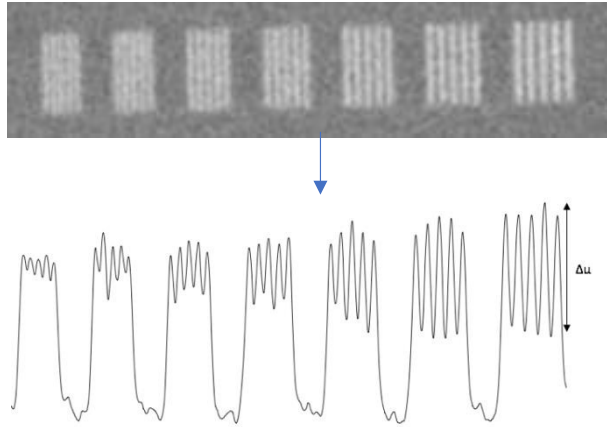

$$pMTF \text{ line pair } (i) = \frac{\Delta\mu(i)}{\Delta\mu}$$

Results

X-ray tube head down:

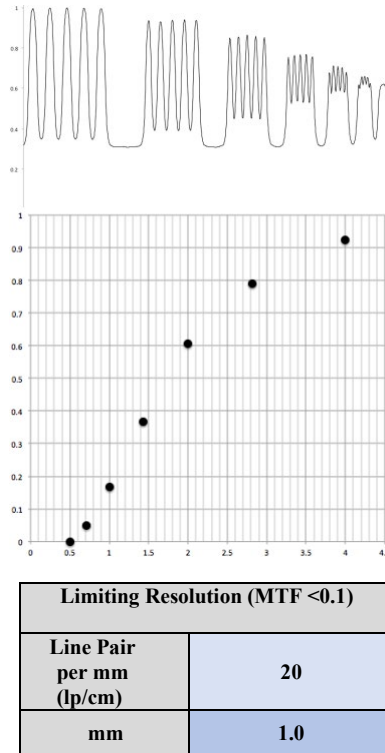

X-ray tube head up:

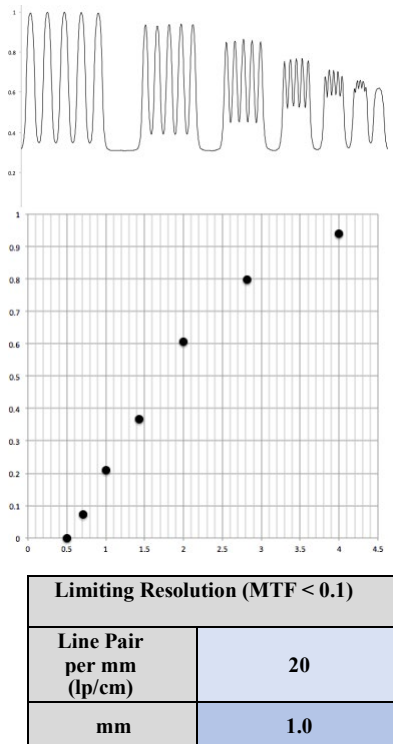

Z-axis point spread function

The LineUP has a fixed and rigid patient positioning platform that does not incorporate any table motion or indexing (no “table pitch”). The detector panel has a square shape, while the pixels on the panels are square shaped as well. The raw projections are acquired in a single 360 degree orbit, thus covering the entire Field of View (FOV) height in one rotation. This results in isotropic voxels in the reconstructed volume, hence the same spatial resolution in the z-axis as in the x-y plane. Due to this projection geometry, calculation of a separate z-axis point spread function should not be applicable.

Recommended Operating Requirements

Local agencies or government bodies or international standards may dictate requirements for installation of the system in order to protect personnel and the public from exposure from the radiological output of the device. Consult your local agencies, government bodies, or international standards for actual requirements which apply.

It is recommended that a qualified Physicist or Radiologist determine where appropriate, the applicable lead shielding to be installed in the area around the system equipment. Below are some other common requirements that may apply to your location:

- The Operations computer (server) and X-ray Operator should be located behind a properly shielded permanent barrier. A viewing window should be present to enable the X-ray Operator to view the Patient and operate the computer while the exposure is present.
- Operators should consider the use of a lead apron to protect the anatomical areas of the medical personnel working in the areas exposed to radiation.
- The Operator Control Box and Acquisition Computer shall be located within 1 meter [3.28 ft] from a door. If not, an interlocked door may be required.
- A room door may be required.
- Radiation warning signs may be required next to the entrance to the room.
- A Warning light may be required by the entrance to the room.
- A shielding plan should be performed where the system is being installed. Some local agencies or government bodies require that a shielding plan be conducted by a qualified Physicist or Radiologist and a copy of the shielding plan be submitted and approved prior to installation of the system.
- An area radiation survey by a qualified physicist or Radiologist may then be required within 30 days of initial clinical use of the system. This survey may be required to be submitted to the local agency or government body

Site Survey

Site Survey TYPICAL LineUP LAYOUT

Location of all "red box" items must be defined before installation

Operator to maintain at least 3 meters from unit during scan. Control box to be mounted outside of room. If mounting inside room lead shield must be used. When using lead shield it must be between the operator and unit. A smaller room can be used as long as a shielding plan is developed and recommended by a Physicist.

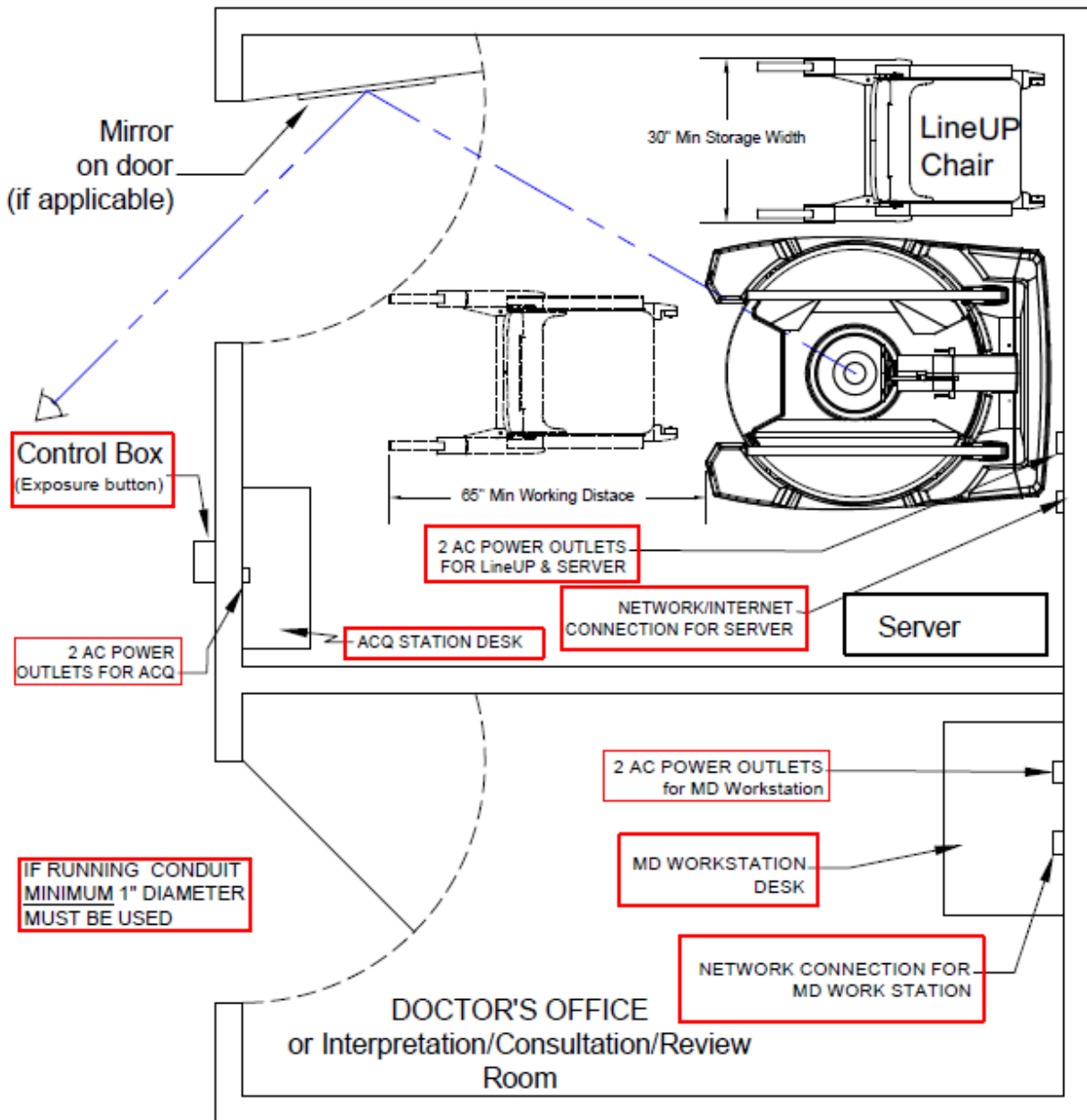

1030-SiteSurvey REV_A

X-ray Tube Assembly

CurveBeam utilizes an X-ray Tube, model SXR 130-20-0.5, from Superior X-ray Tube Co, 1220 Claussen Drive, Woodstock, IL 60098. Below are the X-ray Tube Specifications:

Superior X-ray Data for the SXR 130-20-0.5:

SXR 130-20-0.5

The SXR 130-20-0.5 insert is a stationary anode, glass envelope x-ray tube. The SXR 130-20-0.5 is an x-ray tube originally designed for use in dental CBCT* applications. The insert should be housed in a unit that allows for insulating media such as high dielectric mineral oil (Diala-AX) or high dielectric pressurized gas such as SF₆ (Sulfur Hexafluoride).

* Cone Beam Computerized Tomography

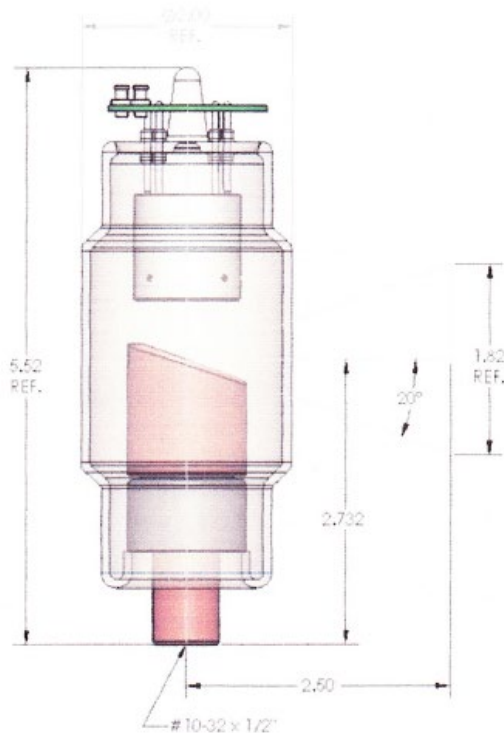

SXR 130-20-0.5 Outline Drawing

Physical Characteristics:

Glass Frame:	Borosilicate 0.085 thick:
Inherent Filtration:	1.1 mm Al equivalent at 80 kV
Focal spot:	0.5 mm Nominal
Target Angle:	20°
Target Material:	Tungsten
Filament Material:	Tungsten
Focus Cup Material:	Nickel
Anode Body:	Copper

Thermal Characteristics:

Anode Heat Storage Capacity:	30 KHU's (21KJ)
Max Anode Heat Dissipation Rate:	17.9 KHU's/min.
Duty Cycle:	1:20

Electrical Characteristics:

Max. Tube Potential:	130 kV
Filament V-A Curve:	See Chart
Max. Power:	See Chart
Max Single exposure:	See Chart
Max. Continuous Exp.	1.8 mA

NOTE: * Please contact Superior Engineering Department for cathode terminations options.

Half Value Layer (HVL): 10.5mm Al equivalent
 No Selectable Filters.
 No Shaped Filters.

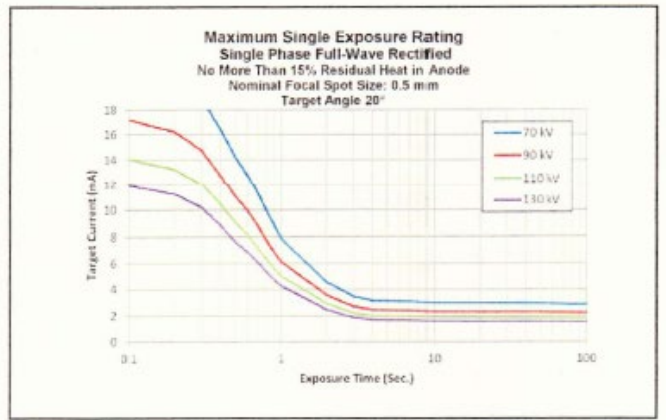
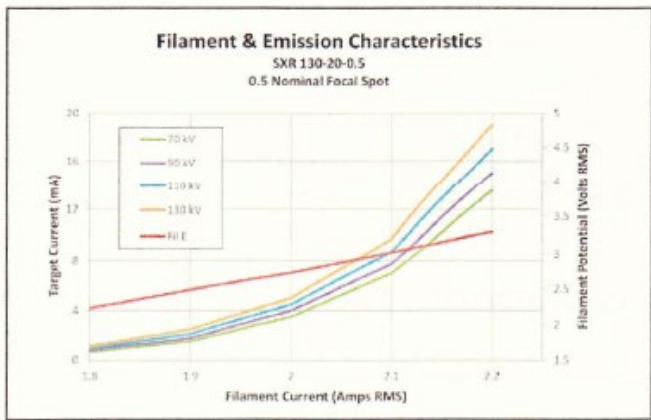
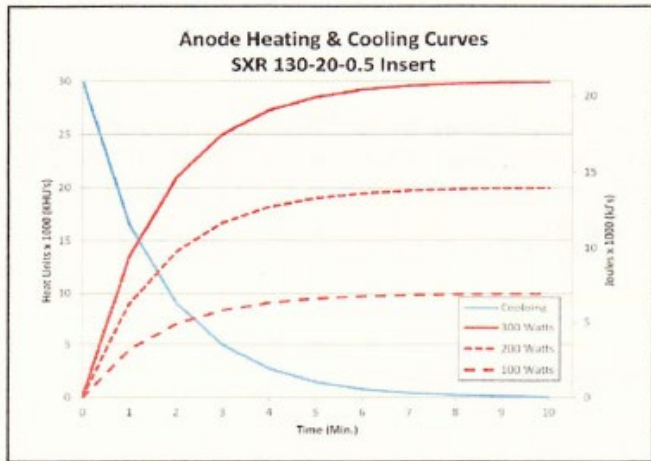

Beam Path and Angulation

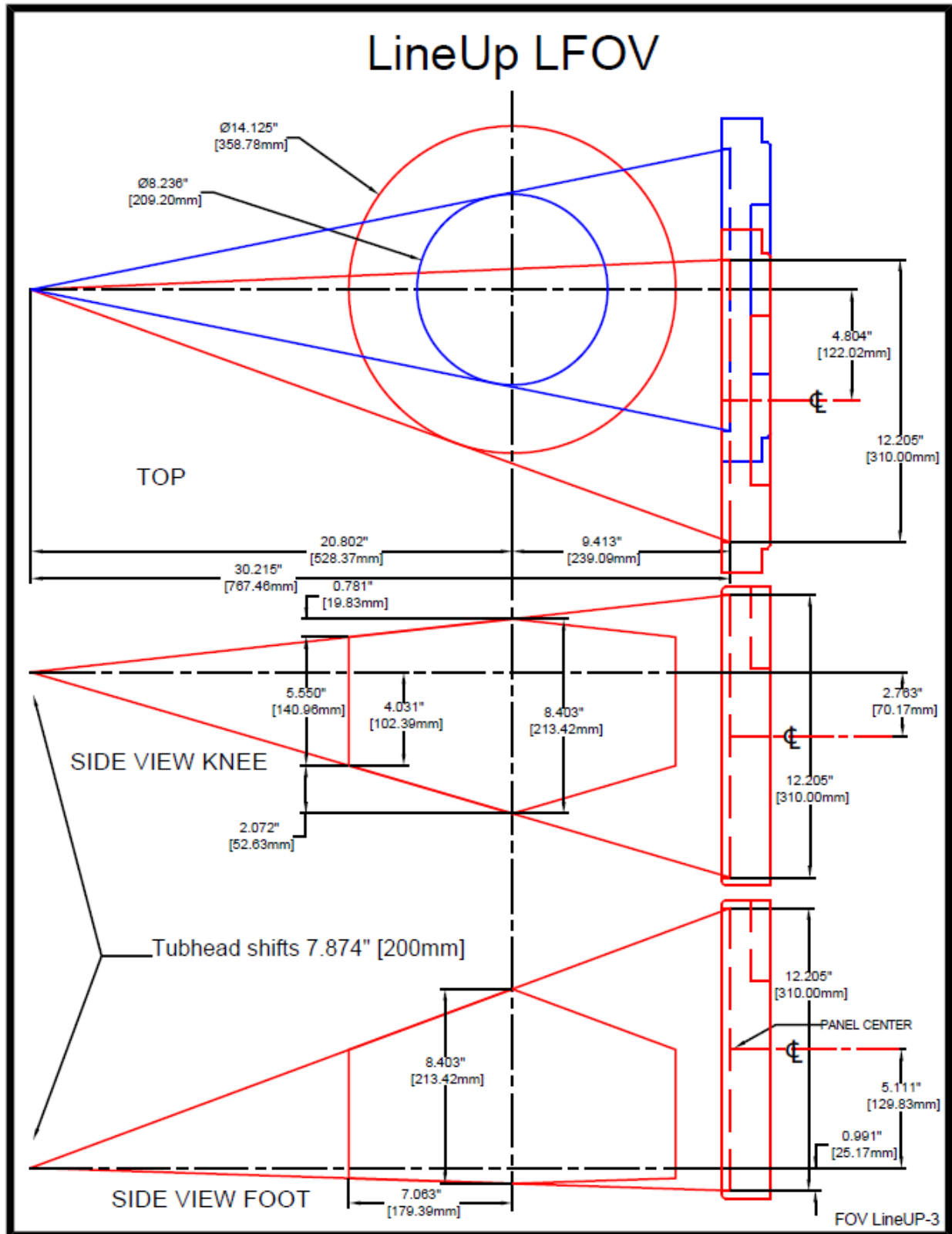

CHAPTER 6: Operations - Acquiring a Scan

System Startup

The LineUP system at a minimum includes the Scanning device, the computer server, and an Operator's control Terminal. All must be powered **ON** in order for the system to operate properly.

The Scanning device circuit breaker should always be set to the ON position. This is located in the back left side of the machine. This is the machine ON/OFF control. The vertical line (|) is the ON position. The circle (0) is the OFF position.

Power ON is indicated on both the Machine Status Indicator panel and the Operators control box Status indicator panel lights. Power ON is lit in **Green**. **The machine must be ON for 30 seconds before the Acquisition Software should be launched. Optimal Scanning results will be achieved with the machine warmed up for 2 hours.**

Start up the Acquisition software by double clicking on the CB-Scanner Shortcut.

When using the Acquisition software, if an error occurs, the software should be closed and restarted.

If cycling power on the Acquisition software does not clear the error, please contact CurveBeam Technical support at the number listed on the cover of the manual.

Visually inspect the device before use for any damage to the covers that exposes internal components.

LineUP Acquisition Software Interface

The LineUP Acquisition Software, "CB Scanning Device" Interface consists of the below sections, each with its own tab near the top of the screen:

- Patient: Access or Add New patient information and intended procedure.
- Protocol: The user will set up scan parameters, such as scan protocol.
- Scan: Perform the Scan Acquisition.
- Quality: Perform a QA (Quality Assurance) check of the scan acquired.

To view the software version that is being run, click on Help, then About.

PATIENT Tab: Accessing/Entering Patient Information & Selecting Scan Procedure

Patient Demographic Information can be either imported into the system via a Worklist or can be Added as a “New Patient” via the LineUP ACQ software Patient Tab when “Add Patient” is selected. The Patient Screen will appear as shown below:

The screenshot shows the CurvBeam ACQ software interface. On the left, there is a sidebar with various input fields for patient information, including Patient Name, Patient ID, Birthdate, Gender, StepID, Accession Number, Scheduled Time, Referring Physician Name, Requesting Physician Name, Study UID, Procedure, Body Part, Laterality, Protocol, Series Description, Frames, kVp, mA, ms, Dose Area Product, CTDI, and Notes. The main area displays a table with patient information:

Patient Name	Protocol	Scan	Quality
Jones, Jacob	123-ABC	14	20001209
Smith, Sam	987654321	15	19900502

Below the table, there are buttons for 'Refresh Worklist', 'Remove Patient', 'Add Procedure for Patient', and 'Add Patient'. The 'Add Patient' button is highlighted with an orange box and labeled 'Add Patient Button'.

To add a patient’s scan to the Worklist, select the “Add Patient” button at the bottom of the screen. If a procedure needs to be removed or is added by mistake or needs to be removed, highlight the entry in the worklist and select the “Remove Patient” button at the bottom and the patients scan will be removed from the list.

When the “Add Patient” button is selected, the following pop up box will appear for patient information to be added:

Procedure	
CT	X-ray
Description	Code
CT	CT
CT Left Elbow	CT_ELBOW_L
CT Right Elbow	CT_ELBOW_R
CT Single Foot	CT_FOOT
CT Both Feet	CT_FOOT_B
CT Left Foot	CT_FOOT_L
CT Right Foot	CT_FOOT_R
CT Left Hand	CT_HAND_L
CT Right Hand	CT_HAND_R
CT Both Knees	CT_KNEE_B
CT Left Knee	CT_KNEE_L
CT Right Knee	CT_KNEE_R

On the Add Patient Procedure window, at a minimum, the Patient Name, Patient ID, and Procedure must be filled in or selected for a patient to be added to the worklist. Some procedure names may vary from those listed in the screen shot above. The Referring and Requesting Physician fields are drop down lists. Values can be entered in manually or selected from the drop-down lists.

These drop-down lists can be added to with a call into CurveBeam technical support, if not done at installation.

Please note, 2D X-ray procedure is not to be used for pediatric cases.

After all of the fields are entered, select the “Add Patient” button to add the patient to the Worklist.

If a patient already exists in the Worklist and an additional Procedure is required, this can be accomplished by just clicking on the “Add Procedure for Patient” button at the bottom of the screen, as shown below:

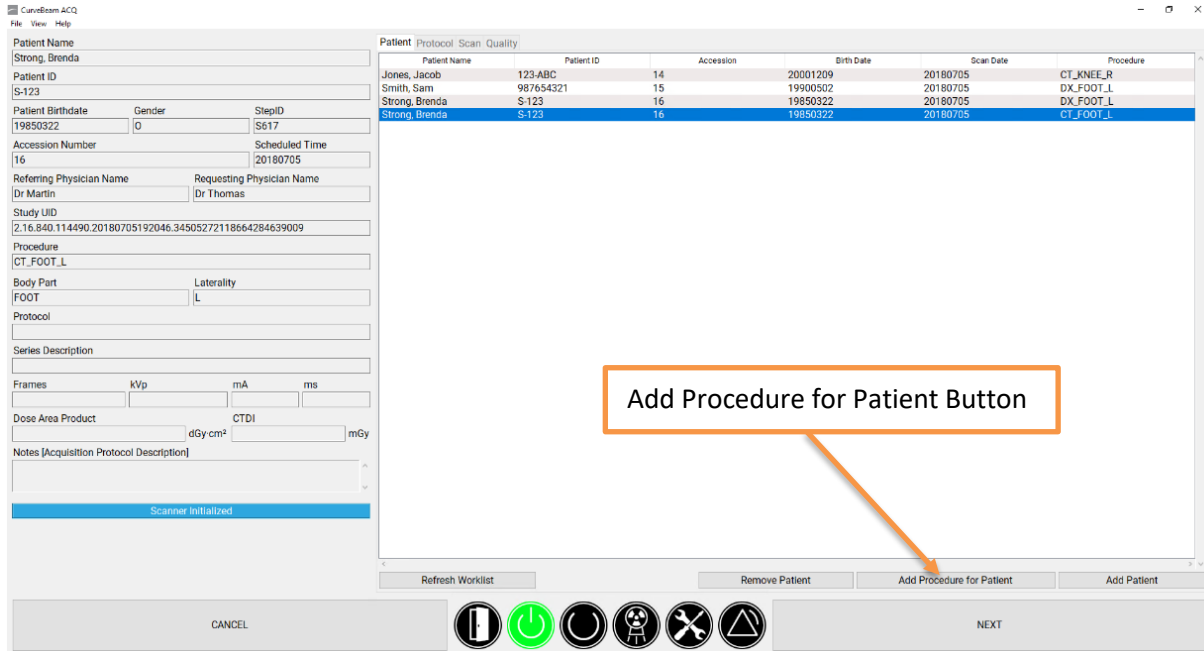

And the Add Procedure for Patient window will open, this is the same as the Add Patient window, except the values already entered for this patient are automatically filled in and grayed out, as shown below:

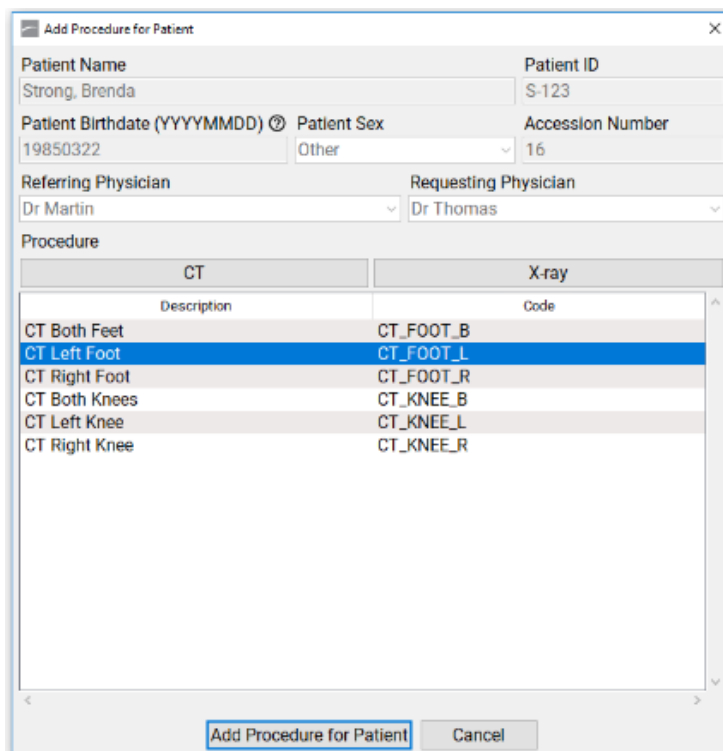

All that is then required is to select a Procedure for the patient, select "Add Procedure for Patient" and then the additional procedure will appear in the Worklist.

Once back on the Worklist, to select the patient for the scan, highlight the patient's entry with the desired procedure. The patient's information that was entered will appear on the left side of the screen.

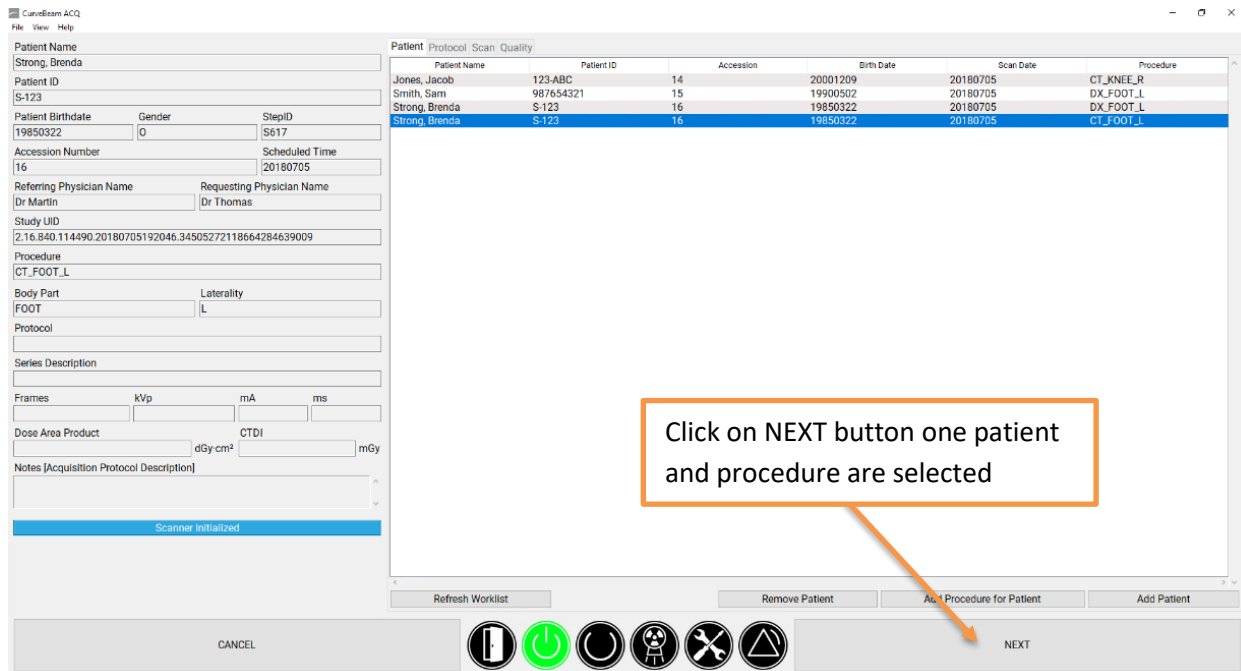

Once the patient has been selected, click on “Next” button to move to the Protocol tab. The “Next” button will remain grayed out until the patient has been selected.

PROTOCOL Tab: Selecting the Protocol

The Protocol desired is selected as well as to enable or disable the use of the Metal Artifact Reduction (MAR) option on the Protocol tab.

The screenshot shows the 'Protocol' tab in the CuveBeam ACQ software. On the left is a patient information form with fields for Patient Name (Strong, Brenda), Patient ID (S:123), Patient Birthdate (19850322), Gender (O), StepID (S617), Accession Number (16), Scheduled Time (20180705), Referring Physician Name (Dr Martin), and Requesting Physician Name (Dr Thomas). The main area displays a table of protocols:

Description	Code	Type	Field of View	Frames	kVp	mA	ms	DAP	CTDI
Large Field Lite	X-CBCT_DB_100	CT	Large Field with Tube Down	480	100	5.0	12	5,352	1,163
Large Field Standard	X-CBCT_DB_120	CT	Large Field with Tube Down	480	120	5.0	12	8,727	2,014
Medium Field Lite	X-CBCT_DC_100	CT	Medium Field with Tube Down	480	100	5.0	12	5,214	1,163
Medium Field Standard	X-CBCT_DC_120	CT	Medium Field with Tube Down	480	120	5.0	12	8,674	2,014

Below the table, there is a checkbox labeled 'Enable Metal Artefact Reduction Option (MAR)'. Below this checkbox is explanatory text: 'Metal Artefact Reduction (MAR) allows respective artefacts caused by implants and dense bone, etc. to be reduced significantly. When MAR is disabled, a density absorption filter is applied to differentiate hard and soft tissue. When MAR is enabled, specialized algorithms detect, isolate and suppress artefacts while also preserving image quality in artefact-free regions. As with all MAR tools, not all artefacts can be completely suppressed.'

For 2D Procedures, the list of Protocols that can be selected by the user differ based on the anatomy selected, direction of scan, and the size of the patient. Once the anatomy is selected, then select the direction of the scan (PA/AP/Lateral) and either a Standard dose or a Lite dose. Lite dose should be used if the patient size is small (under 100lbs). A complete list of the 2D Protocols can be found in Appendix II – Scan Protocol Technical Details.

For the 3D Procedures, the list of Protocols that can be selected by the user differ based on the anatomy selected and the size of the patient. Once the anatomy is selected from the protocol selection, then select either a Standard dose or a Lite dose. Lite dose should be used if the patient size is small (under 100lbs). A complete list of the 3D Protocol Codes can be found in Appendix II – Scan Protocol Technical Details.

The 3D Protocols are a combination of one of the two tube head positions, field of view size, and the kVp. Tube head position is based on the anatomy being scanned and can not be altered by the user once the desired anatomy to scan is selected.

RECOMMENDATIONS for Selecting a Protocol: There are at most 8 CT Protocols from which to select for each of the 3D procedures. The options available will vary based on the Procedure selected. They can have the following attributes:

Medium Field Standard(120kVp): (20 cm diameter x 20 cm height, 0.3 voxel):

Select this option if the patient size is normal-large (100lbs or larger), and if you need to capture only one foot or a partial area of interest for one foot, hand, or elbow

The Medium Field 120kVp protocol codes are either “X-CBCT_DC_120” or “X-CBCT_UC_120”

Large Field Standard(120kVp): (35 cm diameter x 20 cm height, 0.3 voxel):

Select this option if the patient size is normal-large (100lbs or larger), and if you need to capture both feet or both knees in a scan

The Large Field 120kVp protocol codes are either “X-CBCT_DB_120” or “X-CBCT_UAL_120”

Medium Field Lite (100kVp): (20 cm diameter x 20 cm height, 0.3voxel):

Select this option if the patient size is small (under 100lbs), and if you need to capture only one foot or a partial area of interest or a hand or elbow.

The Medium Field 100kVp protocol codes are either “X-CBCT_DC_100” or “X-CBCT_UC_100”

Large Field Lite(100kVp): (35 cm diameter x 20 cm height, 0.3 voxel):

Select this option if the patient size is small (under 100lbs), and if you need to capture both feet or both knees in the scan.

The Large Field 100kVp protocol codes are either “X-CBCT_DB_100” or “X-CBCT_UAL_100”



WARNING The patient must wear a protective full wrap X-ray shielding apron (lead apron) during a scan. Patients less than 21 years old, small size patients (under 100 pounds) and children must also wear a gonad and ovarian front and back protective shield.

Also available on this tab is the MAR selection. If there is metal in the anatomy being scanned, the MAR option will help to eliminate some of the metal artifact that can be seen in a scan on a patient with metal in the field of view. Selecting or deselecting this option is done on a per scan basis. If this same patient requires a second scan, the check box would revert back to the default value. To have the default value changed, please contact CurveBeam Technical Support.

Once the Protocol is highlighted, the “Next” button will become non-gray. Click “Next” when the protocol is correct for the patient being scanned to continue with the Acquisition process.

SCAN Tab: Performing the Acquisition

The Acquisition will be performed via the “Scan” Tab. The Scan Tab will display the current selected Patient Name and Procedure, as well as User Instructions and Information as to the status of what the software and scanner are doing. The Scan Tab will appear as follows:

The screenshot displays the CurveBeam ACQ software interface for the Scan Tab. The interface is organized into several functional areas:

- Patient Information:** Fields for Patient Name (Strong, Brenda), Patient ID (S-123), Patient Birthdate (19850322), Gender (O), StepID (S617), Accession Number (16), Scheduled Time (20180705), Referring Physician Name (Dr Martin), and Requesting Physician Name (Dr Thomas).
- Series Description:** A dropdown menu showing CT_FOOT_L-X-CBCT_DB_120.
- Operator Name (REQUIRED):** A list of predefined operators from A to P.
- Instructions and Status:** A central panel with a 'CAUTION' message, instructions for the operator and scanner, and a 'Scanner Initialized' status bar.
- Navigation:** Buttons for CANCEL, a set of icons (stop, power, home, etc.), and NEXT.

The Series Description can be selected from the pulldown list, or typed in as desired. This field is optional. The Notes field is free form text and is also optional.

The Operator Name is a required field and must be selected. The list of operators can be configured at installation or can be modified by calling into CurveBeam Technical Support.

Instructions for how to proceed can be found in the center of the screen. Once the Operator Name has been selected, at a minimum, the Prepare Scanner for Patient will become active. Once selected, the system will make adjustments based on the selected scan. It is important to keep the scan area clear while the scanner is making these adjustments.

Once the scanner has been set up, then it is time to position the patient in the scanner. Watch for the instruction to position the patient in the blue box on the left side. When instructed to position the patient, use the instructions shown in Chapter 7.

Once the patient is properly positioned close the Patient Gate.

 **WARNING** Closing of the Patient Gate creates a pinch point. Keep hands and feet clear when closing Patient Gate

Next, a message will appear on screen instructing the operator to: “Press and HOLD Scan button”.

 **WARNING** The X-ray device may be dangerous to the Patient and Operator if you do not observe and follow operating instructions. Do not operate this system unless you have received training to perform a procedure.

The Scan Button to start the exposure is mounted on the Operator control box.

1. Deliver the Patient Scan Instructions to the patient.

Patient Instructions for a Scan:

Once the patient is properly positioned in the system, the operator should instruct the patient to **hold perfectly still for the duration of the scan**. It is very important for the patient to hold still. If the patient moves during the volume scans, the results may not be optimal. Data is being captured when the alarm is audible (and x-ray light is ON).

2. Now Push & Hold the scan button down. During exposure an audible signal is generated by the machine, and the visual X-ray ON indicator lights will be illuminated in Amber color. The visual X-ray ON indicators are on the machine, the operator control box (above) and in LineUP Acquisition “CB Scanning Device” software. The Operator should hold the exposure switch for the duration of the exposure as indicated by sound and lights.
3. When the audible buzzer and “X-ray on” light turn off, it is OK to release the exposure switch.

NOTE: If the exposure switch is released before the exposure time has completed, the system will STOP exposing, however the gantry and motors will complete their sequence. If the button is released prematurely, the buzzer and indicator lights will turn off and an Error message will display on screen.

Emergency Stop: In the event of an emergency during a procedure (any moving component collides with any parts of the equipment or items in the environment, or that could cause physical injury to the Patient), the Operator or Patient should utilize one of the 2 the designated Emergency Stop buttons to turn off the power to the X-ray and all moving parts in order for the Patient to be safely removed from the machine. There is an Operator E-stop button on the Operator Control Box and there is a Patient E-Stop button on the machine. The Emergency Stop(s) when activated will remove ALL power from the machine.

4. Once the capture is complete, the Patient Door should be opened. The patient can now safely EXIT the machine.

- If the patient is Standing, he/she should turn around while still on the platform, using the handle bars for support and step forward out of the machine.
- If using the Patient Bench, the patient should stand, then turn around while still on the platform and holding the handle bars. Remove the Patient Bench, then have the patient walk out using the handle bars for support. Assist them as needed.
- If using the Multi-Extremity Chair for a foot scan, have the patient stand, then turn around while still on the platform and holding the handle bars. Remove the Multi-Extremity Chair, then have the patient walk out using the handle bars for support. Assist them as needed.
- If using the Multi-Extremity Chair for a hand or elbow scan, have the patient remove their arm from the back hole in the chair. Raise the back of the chair. Assist the patient out of the chair.
- If using the Multi-Extremity Chair and Serial Number LU30001 or LU30002, for a hand or elbow scan, have the patient remove their arm from the back hole in the chair. Raise the back of the chair. Unlock the Multi-Extremity Chair wheels. Roll the chair out of the scanner, ensure it is clear of the scanner. Then fully lower the Multi-Extremity Chair and assist the patient out of the chair.
- If using the Multi-Extremity Stowaway Bench for a foot scan, have the patient stand, then turn around while still on the platform and holding the handle bars. Remove the Multi-Extremity Stowaway Bench. Store the Stowaway Frame. Then have the patient walk out using the handle bars for support. Assist them as needed.
- If using the Multi-Extremity Stowaway Chair for a hand or elbow scan, have the patient remove their arm or elbow from the positioner. If comfortable, the patient can hold the metal uprights to the head rest. Raise the back of the chair. Assist the patient out of the chair.

5. When the Next button becomes visible, click on it.

- Once on the Quality screen, wait for all of the QA images to be present. Initially the QA screen will appear as in the following image.

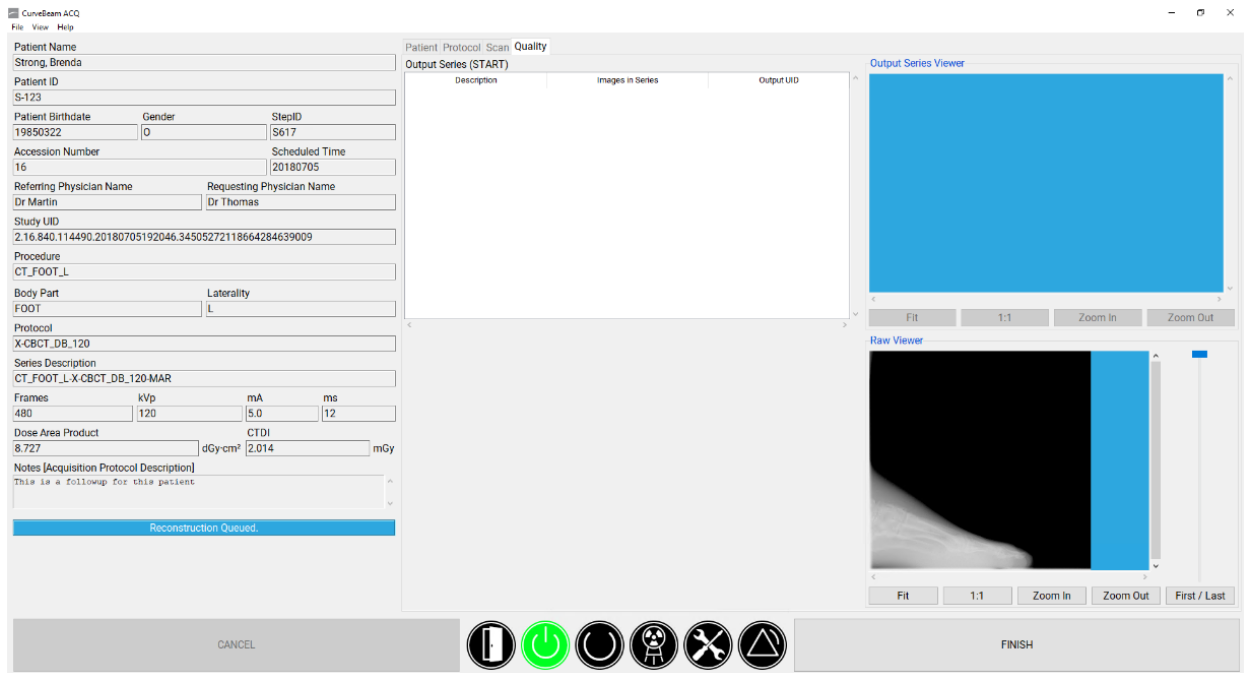

- While waiting for the image to finish processing, check for movement of the patient during the scan, compare the first and last frames. View all images as they were acquired by using the slider below the raw frames. The Output Series Viewer can also be used to view the images, which may take a bit of time for images to appear.
- Processing is completed once “DONE” appears next to Output Series as shown below:

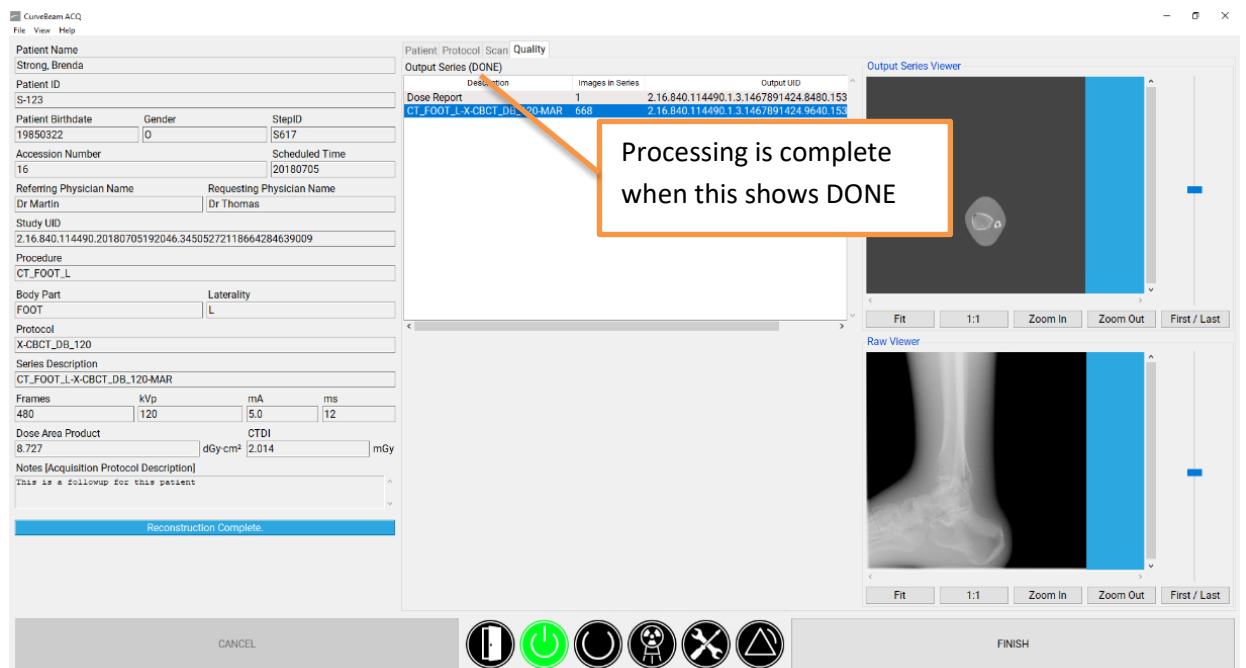

9. Once certain the image looks like the anatomy desired was done so acceptably, click on the Exit button and the software will close.

 NOTE: If there is any indication of vibration to the system, or malfunction to the system, or computer crash during a scan, please contact CurveBeam Technical Support for assistance. If there is a failed procedure, turn the machine off by the Emergency Stop button, following the below procedure.

Turning the System Off

To safely turn off the LineUP scanner, first close the Acquisition software. Then turn off the LineUP Scanner by using the circuit breaker switch that is located on the back left side of the machine. This is the machine ON/OFF control. The vertical line is the ON position. The 0 is the OFF position.

Viewing the Images

Image processing is done using iterative reconstruction of raw projections. Once the image is processed it is then formatted using the DICOM-3 file format. With this format, the image can then be viewed using a DICOM viewer. Both CT and x-ray images can be obtained from the scanner by setting up standard DICOM protocols for retrieving images from the DICOM storage device using the systems AETitle and Port.

CHAPTER 7: Patient Positioning

Before positioning the patient in the machine, remove his/her shoes/socks for a foot scan. We recommend the patient not step bare foot on the patient platform. Proper foot protection should be provided.

For a foot scan, if patient has any jewelry on their toes or ankles, that should be removed.

For a hand scan, if patient has any jewelry on their fingers or wrists, that should be removed.

Have the patient put on FDA approved medical gloves and foot protection as recommended in Ch. 2, Patient Preparation Recommendations section.

Drape the patient with protective shielding for the procedure as recommended in Ch. 1, Radiation Safety section.

The patient will now need to be positioned in the machine. The Patient Door to the machine should now be in OPEN position in order for the patient to step in.

*Be sure to position your patient before clicking the “Begin Scan” button.

3D Positioning

For a foot or feet scan, the patient can be seated (non-weight bearing) or standing (weight-bearing). Instructions are provided below for the following scenarios:

- Weight Bearing 3D Foot/Feet Scan
- Non-Weight Bearing 3D Foot/Feet Scan - Utilizing Multi-Extremity Chair (all LineUP serial numbers except LU30001 and LU30002)
- Non-Weight Bearing 3D Foot/Feet Scan - Utilizing Multi-Extremity Chair (for only LineUP serial numbers LU30001 and LU30002)
- Non-Weight Bearing 3D Foot/Feet Scan - Utilizing Patient Bench
- Non-Weight Bearing 3D Foot/Feet Scan – Utilizing Multi-Extremity Stowaway Bench
- Positioning the Foot/Feet (used for all of the above)
- 3D Knees
- 3D Hand and Elbow – Utilizing Multi-Extremity Chair
- 3D Hand and Elbow – Utilizing Multi-Extremity Stowaway Chair
- 2D Scans

These instructions for utilizing the various patient support devices are then followed by an explanation of how to position the feet on the patient platform. This description of foot position should be used regardless of chair or bench usage.

Weight Bearing Foot/Feet Scan

Have the patient walk into the scanner, using the handles for stability.



Refer to the section titled “Positioning the Foot/Feet” below for specific instructions on placing the feet.

Close the Patient Gate once patient is properly positioned.

⚠ WARNING Closing of the Patient Gate creates a pinch point. Keep hands and feet clear when closing Patient Gate

Once the scan is completed, remind the patient to hold the handle bars for stability, then assist the patient to turn around and walk out of the scanner.

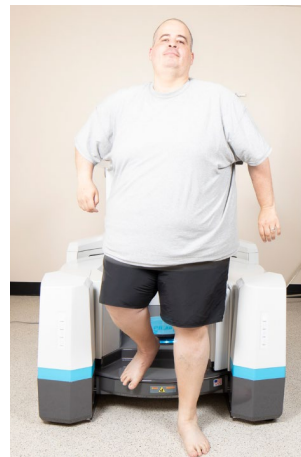

Non-Weight Bearing Foot/Foot Scan – Utilizing Multi-Extremity Chair

If your LineUP Scanner has the Serial Number of LU30001 or LU30002, refer to the instruction after this for initial setup of the Multi-Extremity Chair.

Have the patient walk into the scanner, using the handles for stability.



Steer the Multi-Extremity Chair into the scanning device. The Multi-Extremity Chair should be turned and faced as follows.



Lock the wheels of the Multi-Extremity Chair.

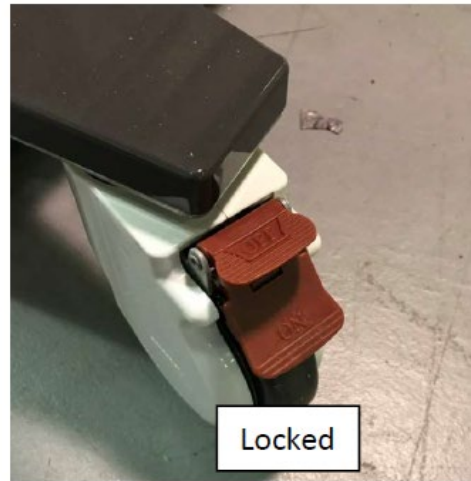
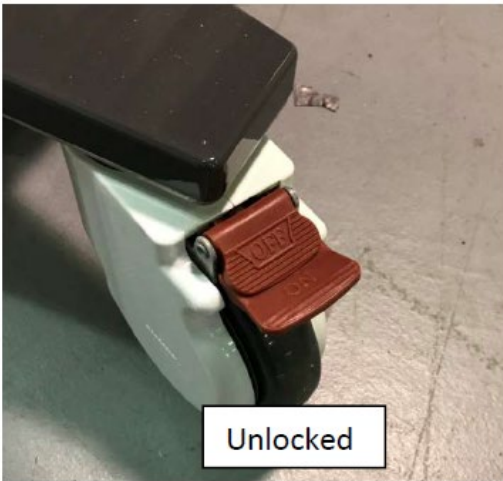

Have the patient sit in the Multi-Extremity Chair, while using the handles for support.



Refer to the section titled “Positioning the Foot/Feet” below for specific instructions on placing the feet.

Close the Patient Gate once patient is properly positioned.

⚠ WARNING Closing of the Patient Gate creates a pinch point. Keep hands and feet clear when closing Patient Gate

Once the scan is completed, have the patient stand, reminding them to hold the handle bars for stability. Unlock the wheels of the chair. Remove the Multi-Extremity Chair from the scanner. Assist the patient to turn around and walk out of the scanner.

Non Weight Bearing Foot/Feet Scan – Utilizing Multi-Extremity Chair (only for LineUP Serial Numbers LU30001 and LU30002)

Before starting, raise the Multi-Extremity Chair to the highest position. Failure to fully raise the chair could result in damage to the scanner and the chair. To raise the Multi-Extremity Chair, press and hold the UP Elevation button as shown below:

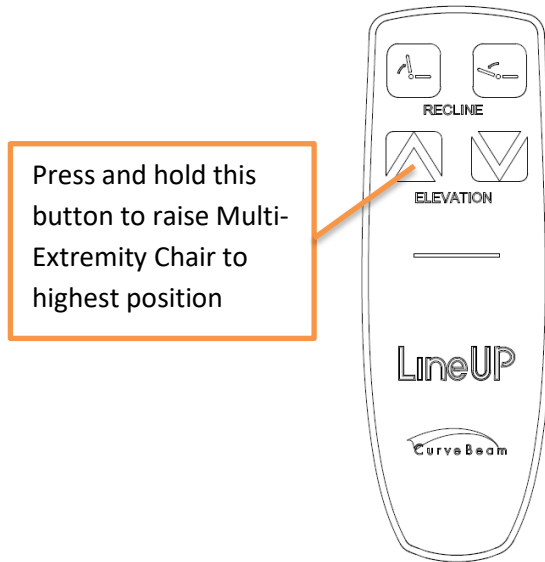

⚠ WARNING Failure to fully raise the Multi-Extremity Chair to the highest position before inserting into the Scanner can result in damage to both the scanner and the Multi-Extremity Chair.

Now follow all of the instructions listed above under “Non-Weight Bearing Foot/Feet Scan – Utilizing Multi-Extremity Chair with LineUP Serial Numbers other than LU30001 and LU30002:” to position the patient properly.

Non-Weight Bearing Foot/Feet Scan – Utilizing Patient Bench

For a non-weight bearing scan utilizing the Patient Bench, first assist the patient into the scanner. Instruct the patient to hold the handle bars for stability.



Then roll the Patient Bench into the scanner until it is fully inserted in the scanner opening. At that point, stabilize the Patient Bench while instructing the patient to sit on the Patient Bench.



Patient should be instructed to hold the handle bars as shown below:



Refer to the section titled “Positioning the Foot/Feet” below for specific instructions on placing the feet.

Close the Patient Gate once patient is properly positioned.

 **WARNING** Closing of the Patient Gate creates a pinch point. Keep hands and feet clear when closing Patient Gate

Once the scan is completed, have the patient stand, reminding them to hold the handle bars for stability. Remove the Patient Bench from the scanner. Assist the patient to turn around and walk out of the scanner.

Non-Weight Bearing Foot/Feet Scan – Utilizing Multi-Extremity Stowaway Bench

For a non-weight bearing scan utilizing the Multi-Extremity Stowaway Bench (referred to as just “Stowaway Bench” in these instructions), first assist the patient into the scanner. Instruct the patient to hold the handle bars for stability. Fully close the patient gate.

⚠ WARNING Closing of the Patient Gate creates a pinch point. Keep hands and feet clear when closing Patient Gate

Next, the Stowaway Frame and Stowaway Bench need to be set up. To accomplish this, the Stowaway Frame needs to be pulled out from under the scanner. To do this, grasp the Stowaway Frame, which functions as a step when stored under the scanner, and pull it out and up as shown below:



When fully extended, push the Stowaway Frame up and in towards scanner where it will lock into place. Once locked, the green Stowaway Frame in Place Indicator will illuminate as shown:



Locate the Stowaway Bench as shown below:



Align the pins on the Stowaway Bench with the holes at the top of the Stowaway Frame.

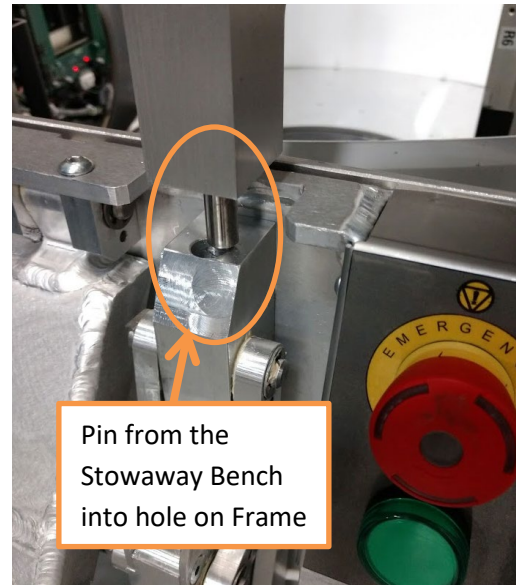
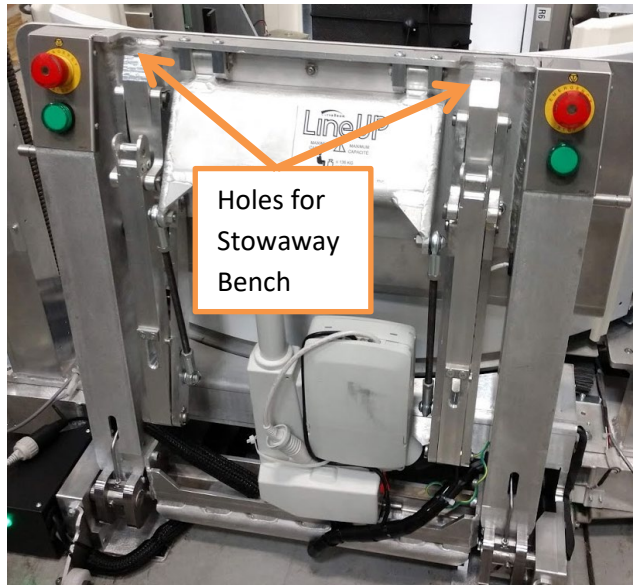

Press down on the Stowaway Bench until it is firmly in place as shown below:



Instruct the patient to sit on the Stowaway Bench. Patient should be instructed to hold the handle bars as shown below:



Refer to the section titled “Positioning the Foot/Feet” below for specific instructions on placing the feet.

Once the scan is completed, have the patient stand, reminding them to hold the handle bars for stability.

Remove the Stowaway Bench from the scanner by pulling up on the metal that extends into the scanner, below the seat. Then locate the Stowaway Frame Release Levers as shown:

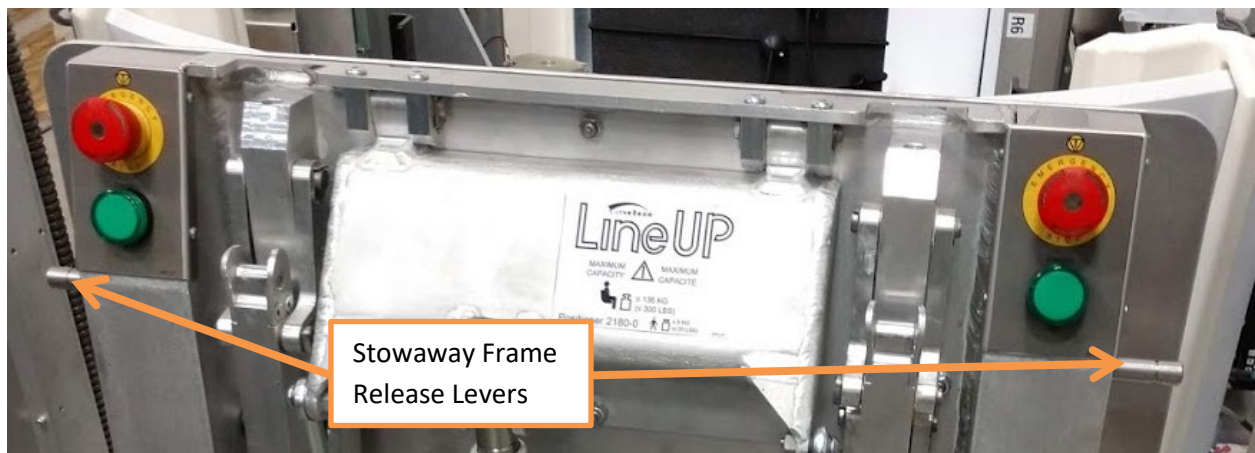

Pull UP firmly on the Stowaway Frame Release levers and then gently pull the Stowaway Frame down and out until it is flat on the floor. Once it is on the floor, slide the Stowaway Frame back under the LineUP Scanner, as shown below:



Open the Patient Gate. Then assist the patient to turn around and walk out of the scanner.

Positioning the Foot/Feet

Circular Positioning Guides:

These guides on the patient platform are intended to assist the operator in positioning the patient's feet/foot into the field of view.

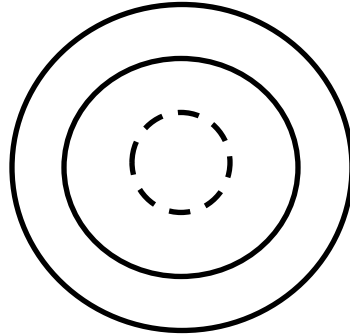

The most outer circle is for the Full one or two feet procedure option (35 cm diameter). This is for a scan that includes one whole foot or both feet.

One or both feet should be positioned within this circle in order to capture both.

Positioning Illustrations are intended for Training purposes only.



Sample Results of Full both feet Field of View



The second circle is for the Partial Single Scan option (20 cm diameter). This is for capturing one foot or a partial scan of one foot only. The area of interest for the scan should be positioned within this circle in order to capture it. If you require the forefoot, then ensure that it is within the inner circle, however the hindfoot may not fit and would not be included in the scan (and vice versa). Smaller foot sizes may capture from Fore to Hindfoot.

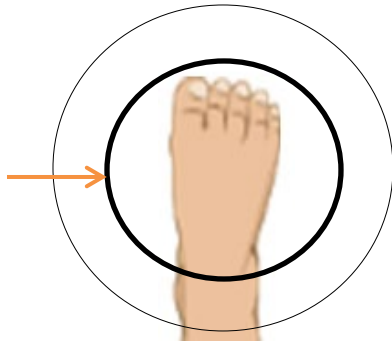

Sample Results of Partial Single Foot Diameter Scan
Field of View, Forefoot

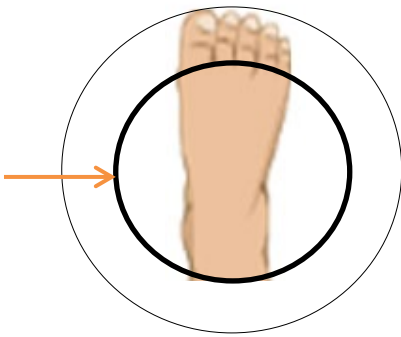
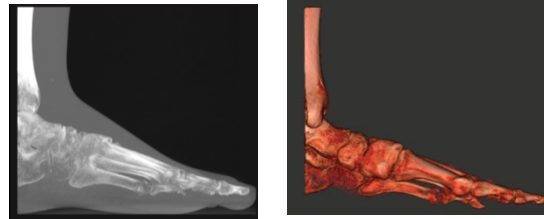

Sample Results of Partial Single Foot Diameter Scan
Field of View, Hindfoot



When taking a single foot scan, the Single Foot Platform can be utilized to raise the non-imaged foot out of the field of view. Ensure the rubber “feet” on the platform are down, as indicated by the label on the platform. And rotate for either left or right foot.



Single Foot Platform

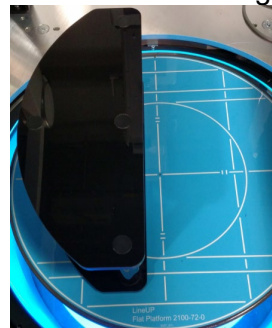

Single Foot Platform on Patient Platform

3D Knees

Knee Scans must be bilateral. Pull down the center column, the Knee Positioner Assembly, so that the Knee Positioner can be properly placed. Then hang the Knee positioner, so that it appears as shown below:

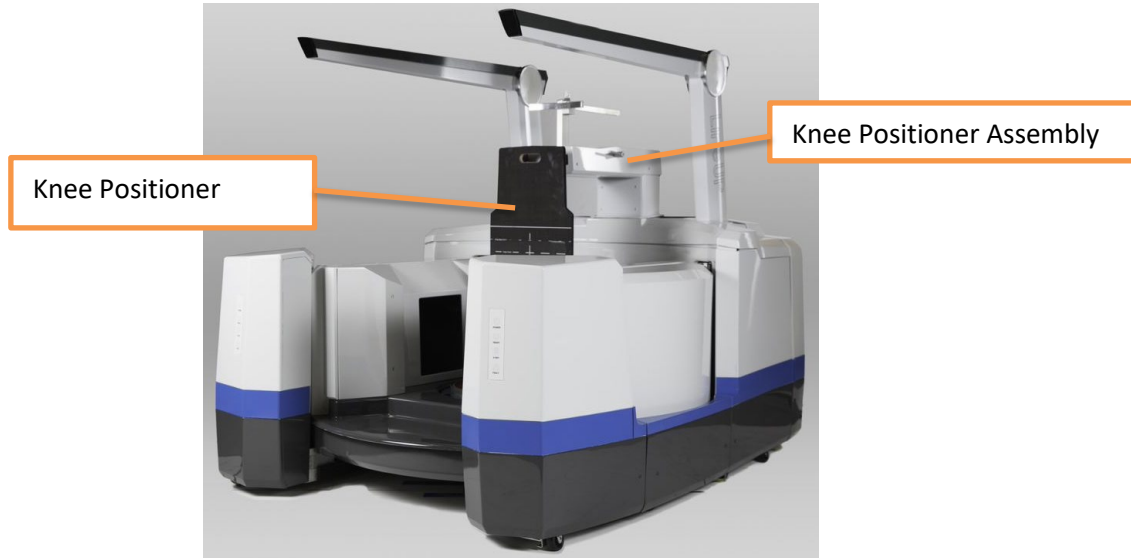

Have the patient walk into the scanner, using the handles for stability.

Knees will need to be positioned as shown, with knees slightly bent and resting against the knee positioner:

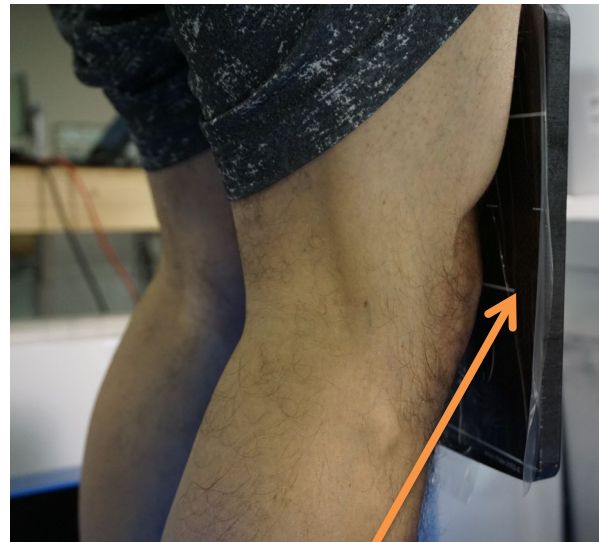
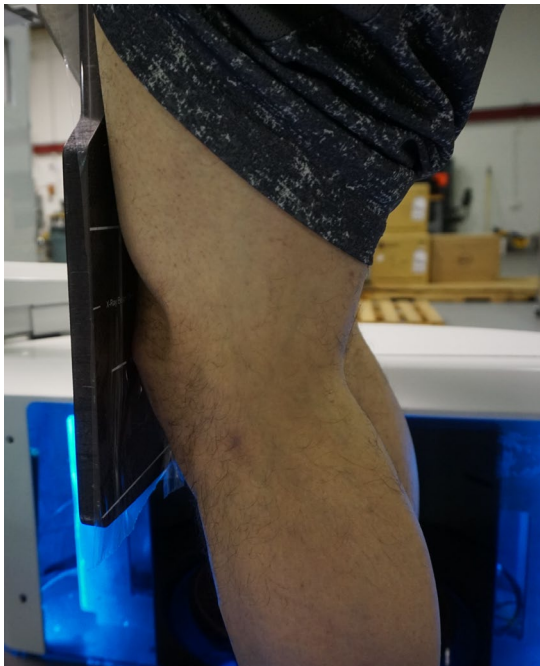

X-Ray Beam Center Line

When prompted in the software, use the hand-held knee positioner control to position the knee platform to a height where the knees are aligned with the “X-Ray beam center” line. All anatomy inside the outer white lines will be imaged. To make adjustments, have the patient move their knees away from the knee positioner, then use the hand-held knee positioner controller to raise or lower the knee positioner.

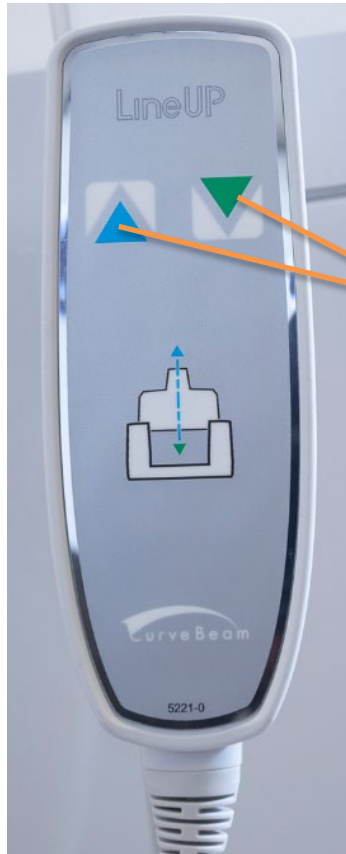

Press to raise and lower the knee positioner

 **WARNING** Do not attempt to raise or lower the knee positioner while the patient's knees are in contact with the knee positioner.

Close the Patient Gate once patient is properly positioned.

 **WARNING** Closing of the Patient Gate creates a pinch point. Keep hands and feet clear when closing Patient Gate

Once the scan is completed, remind the patient to hold the handle bars for stability, then assist the patient to turn around and walk out of the scanner.

3D Hand and Elbow – Utilizing Multi-Extremity Chair

Before doing anything for a hand or elbow scan, ensure the machine is set up for the scan. To do this, remove the knee positioner, if installed. And flip up the center column where the knee positioner hangs, also referred to as the knee positioner assembly.

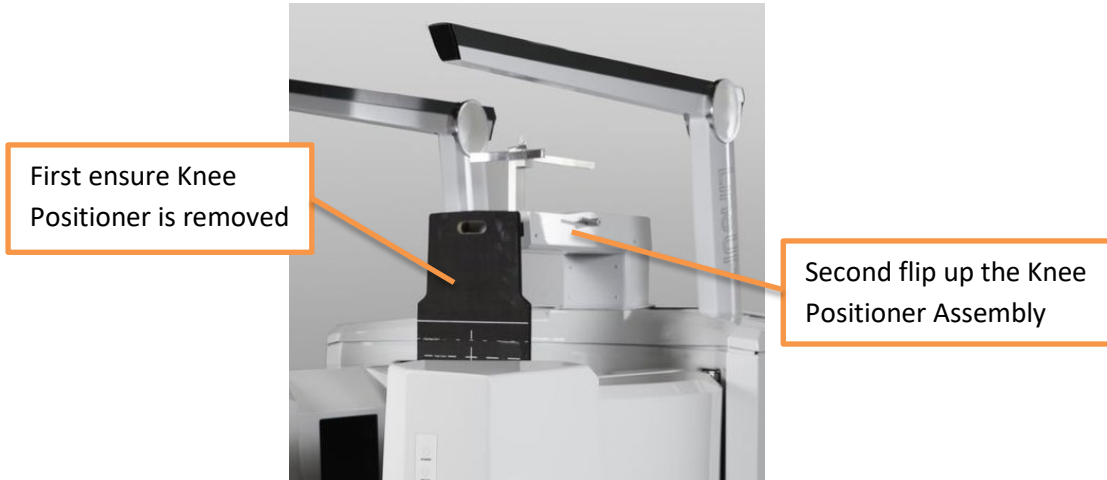

Next, remove the Patient Platform, blue circle that patient stands on for foot scan.

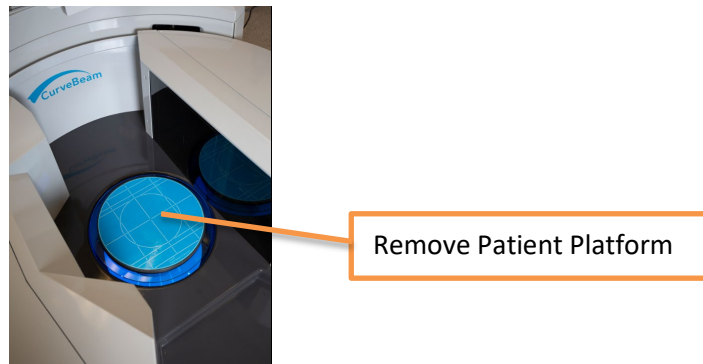

Locate the Hand and Elbow Positioner as shown here:



There are three metal clips under the Hand and Elbow Positioner that will then fit into the metal plate that is under the Patient Platform. It is usually easiest to tilt the Positioner forward a bit and align the three clips, then use a downward and slightly back movement to have the Positioner lock into place. The metal plate under the Patient Positioner is shown here:

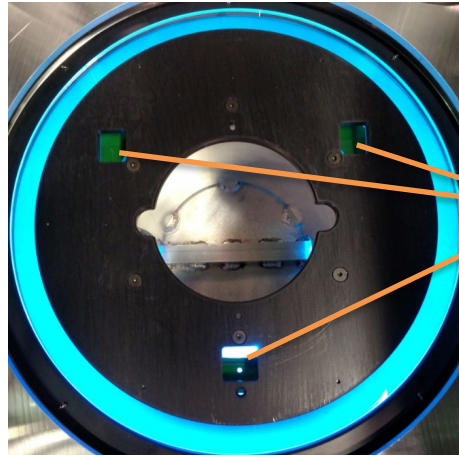

Three holes to align with clips at the bottom of the Hand and Elbow Positioner

Position the Hand and Elbow platform in the scanning device.

Next, the Multi-Extremity Chair needs to be positioned and then inserted into the scanner. The chair should be positioned as shown, with the handle bars on the same side as the entrance to the chair:



Multi-Extremity Chair rotated to allow for Hand and Elbow scans

If the Multi-Extremity Chair is not in this configuration, the seat and back of chair need to be rotated. To do this, locate the handle at the base of the seat, in the back of the chair. It is shown here:



The lever, when pushed to the left, will allow the seat to spin around 180 degrees to the proper position.

If LineUP is Serial Number LU30001 or LU30002 perform the following paragraph:

Lower the Multi-Extremity Chair to the lowest height. Position the chair NEAR the scanner and lined up to roll in to the scanner, but not IN the scanner. Assist the patient to sit in the chair. Then fully raise the Multi-Extremity Chair to the highest position. Roll the chair with the patient into the scanner. Lock the wheels of the Multi-Extremity Chair. Then follow the steps below, skipping over the steps to get the patient into the chair and pick up where it is mentioned to continue for Serial Number LU30001 or LU30002.

Once the Multi-Extremity Chair is in the proper direction for the Hand or Elbow scan, it needs to be rolled into the scanner as shown below:



Then the wheels on the Multi-Extremity Chair need to be locked.

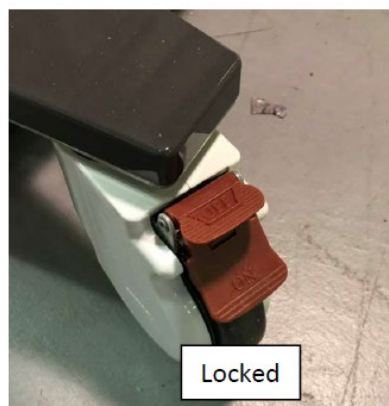

Next, lower the step at the front of the chair to allow patient access:



Then assist the patient into the chair.

If LineUP is Serial Number LU30001 or LU30002 pickup from here and continue from this point forward.

Use the hand controls on the Multi-Extremity Chair to lower the back of the chair into position for the desired scan. For some patients it may be easier to recline the chair with the patient lying on their back, then once reclined, have the patient turn on their side for positioning their hand or elbow in the scanner.

Multi-Extremity Chair tilted to hand position

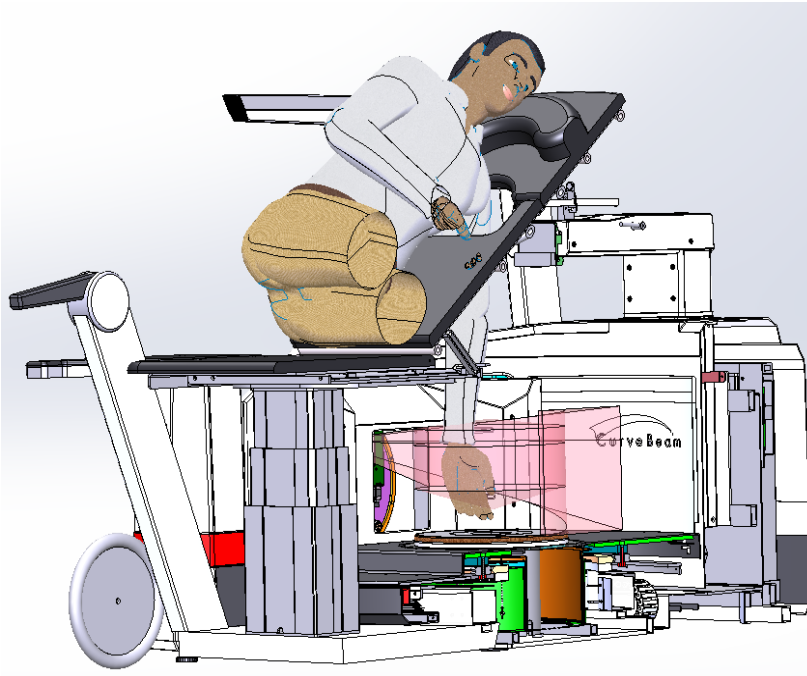

Hand Scans – Small Patients

For small patients it is imperative that the hand and arm are only inserted into the machine just to get the area to be scanned. Ensure the arm is not fully into the machine beyond the anatomy of interest, to reduce unnecessary exposure. Also ensure the shielding is fully wrapped around their arm.

Multi-Extremity Chair tilted to bent elbow position

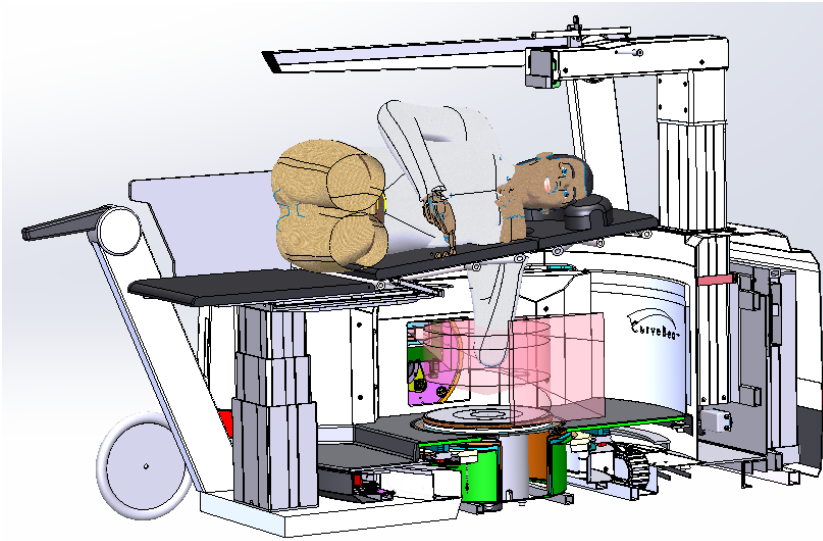

Elbow Scans – Small Patients

For small patients it is imperative that the arm is only inserted into the machine just enough to get the area to be scanned. Ensure the arm is not fully into the machine beyond the anatomy of interest, to reduce unnecessary exposure. Also ensure the shielding is fully wrapped around their arm.

Position the area of interest along the “X-Ray Beam Center” line on the Hand and Elbow Platform. All anatomy inside the outer white trapezoid will be imaged.

Hand Scan:



X-Ray Beam Center Line

Straight Elbow Scan:



Bent Elbow Scan:

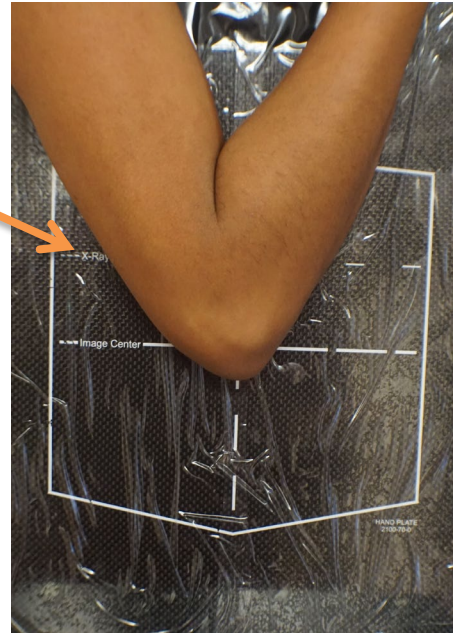

X-Ray Beam
Center Line

Close the Patient Gate once patient is properly positioned.

⚠ WARNING Closing of the Patient Gate creates a pinch point. Keep hands and feet clear when closing Patient Gate

Once the patient scan is done, have the patient bring their arm out of the hole in the back of the chair. Then raise the back of the chair up again to a seated position. Again, for some patients, it may be easier to have them turn on their backs and then raise the chair back to a seated position.

Assist the patient out of the chair, using the step on the Multi-Extremity Chair. Then fold up the step. Unlock the wheel locks, and move the Multi-Extremity Chair out of the scanner.

If LineUP is Serial Number LU30001 or LU30002: Unlock the wheels on the Multi-Extremity Chair, then roll the chair so that it is no longer near the scanner. Lower the chair to the lowest position, then assist the patient out of the Multi-Extremity Chair.

3D Hand and Elbow – Utilizing Multi-Extremity Stowaway Chair

Before doing anything for a hand or elbow scan, ensure the machine is set up for the scan. To do this, remove the knee positioner, if installed. And flip up the center column where the knee positioner hangs, also referred to as the knee positioner assembly.

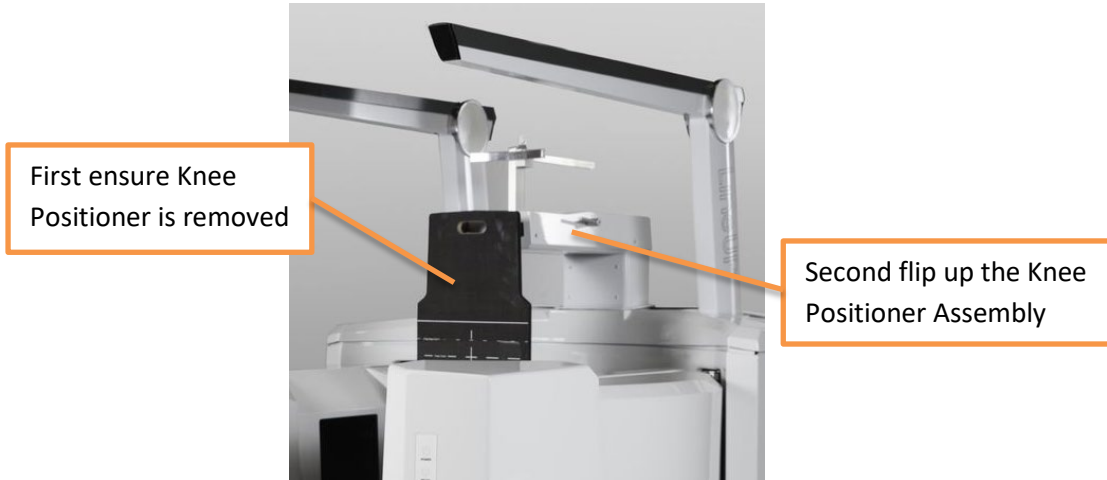

Next, remove the Patient Platform, blue circle that patient stands on for foot scan.

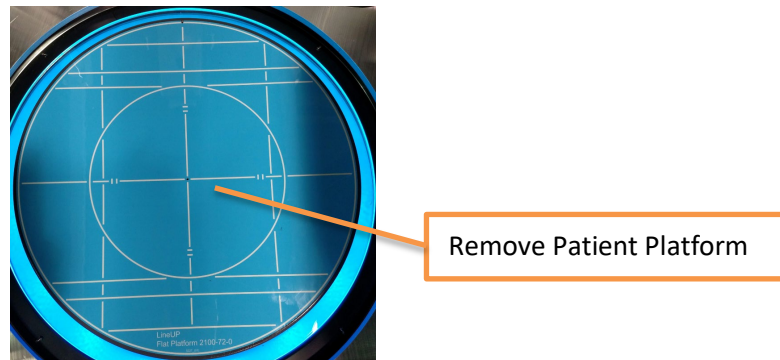

Locate the Hand and Elbow Positioner as shown here:



There are three metal clips under the Hand and Elbow Positioner that will then fit into the metal plate that is under the Patient Platform. It is usually easiest to tilt the Positioner forward a bit and align the three clips, then use a downward and slightly back movement to have the Positioner lock into place. The metal plate under the Patient Positioner is shown here:

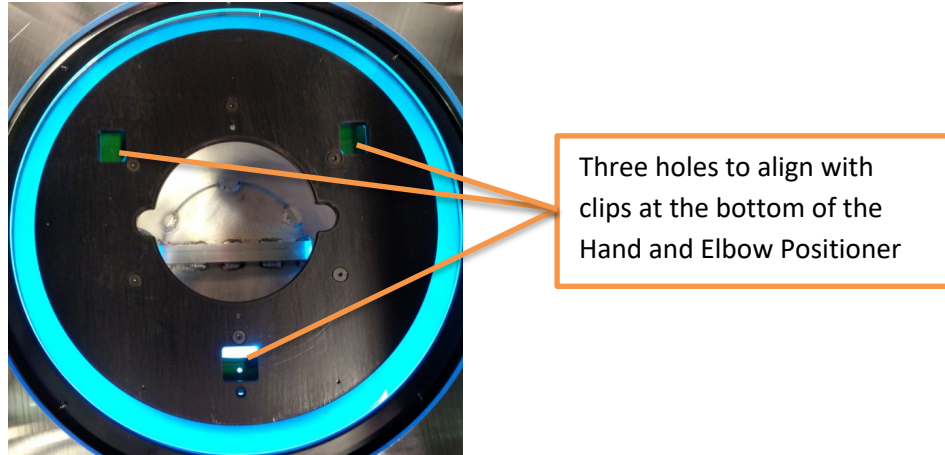

Position the Hand and Elbow platform in the scanning device.

Next, the Stowaway Frame and the Multi-Extremity Stowaway Chair (referred to as just “Stowaway Chair” in these instructions) need to be set up. To accomplish this, the Stowaway Frame needs to be pulled out from under the scanner. To do this, grasp the Stowaway Frame, which functions as a step when stored under the scanner, and pull it out and up as shown below:

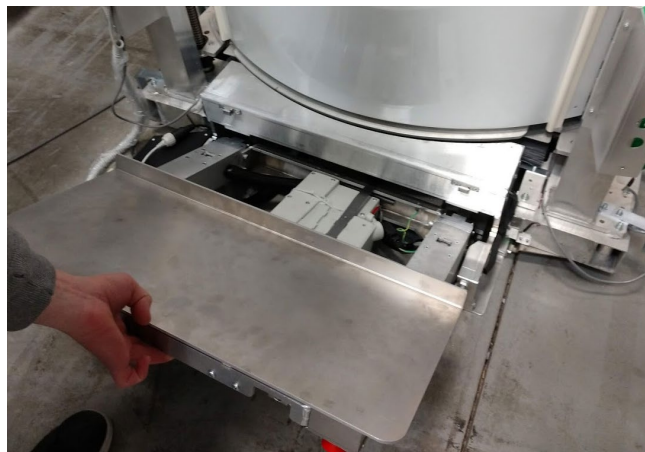

When fully extended, push the Stowaway Frame up and in towards scanner where it will lock into place. Once locked, the green Stowaway Frame in Place Indicator will illuminate as shown:

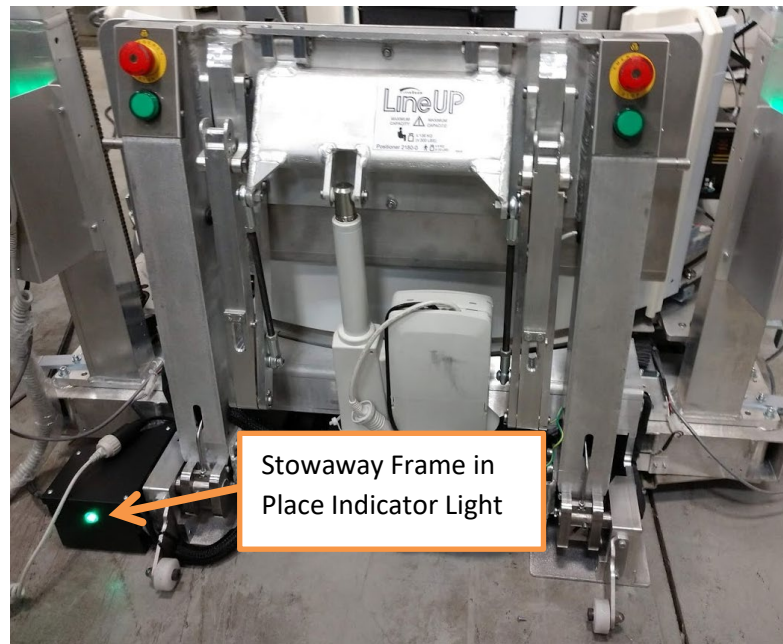

Locate the Stowaway Chair as shown below:



There are two hooks on the back of the chair, about two-thirds of the way down the back of the Stowaway Chair. The hooks are on either side of the on the Stowaway Chair, one is shown below:



Align the hooks on the back of the Stowaway Chair with the back of the Frame.

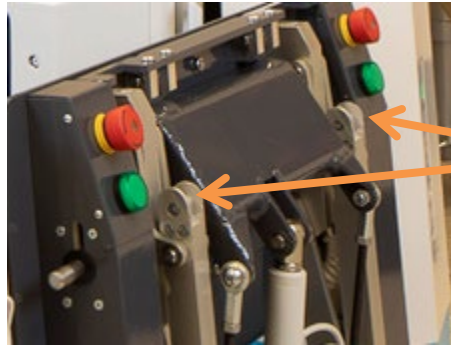

The hooks on the back of the Stowaway Chair hook into these two Stowaway Frame Chair Receivers



Stowaway Chair Hook

Stowaway Frame Chair Receiver

Then press the bottom of the chair towards the Frame. There is a pin at the bottom of the chair, on both sides of the back of the chair, that need to be inserted into holes on the back of the Frame.



Pin at the back of the Stowaway Chair

Hole in Frame for Pin on back of Chair



Chair Pin aligned with hole on Frame

See image below for the progression through the last couple of steps:

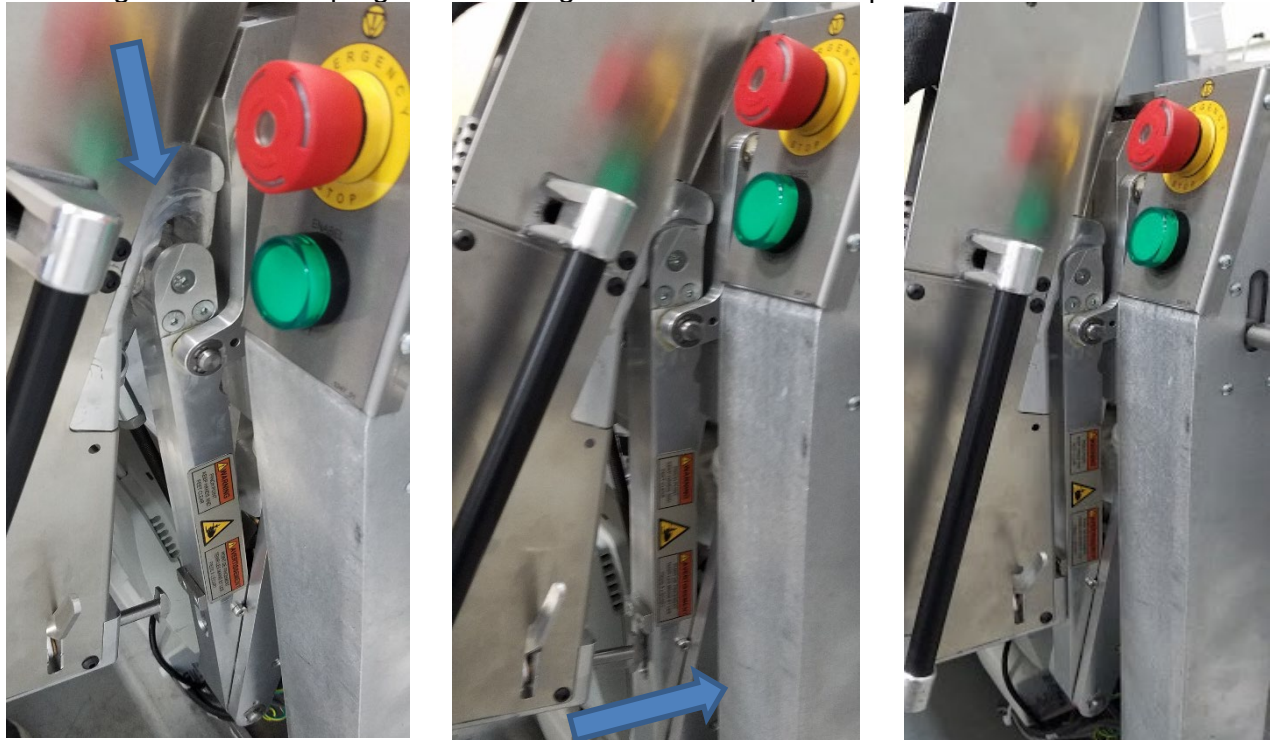

Once the Stowaway Chair is hooked on and pressed against the Stowaway Frame, press down on the Stowaway Chair Lock Lever, on the right side, to lock the Stowaway Chair in place. When the Stowaway Chair is locked in place, the Enable Lift light will be illuminated.

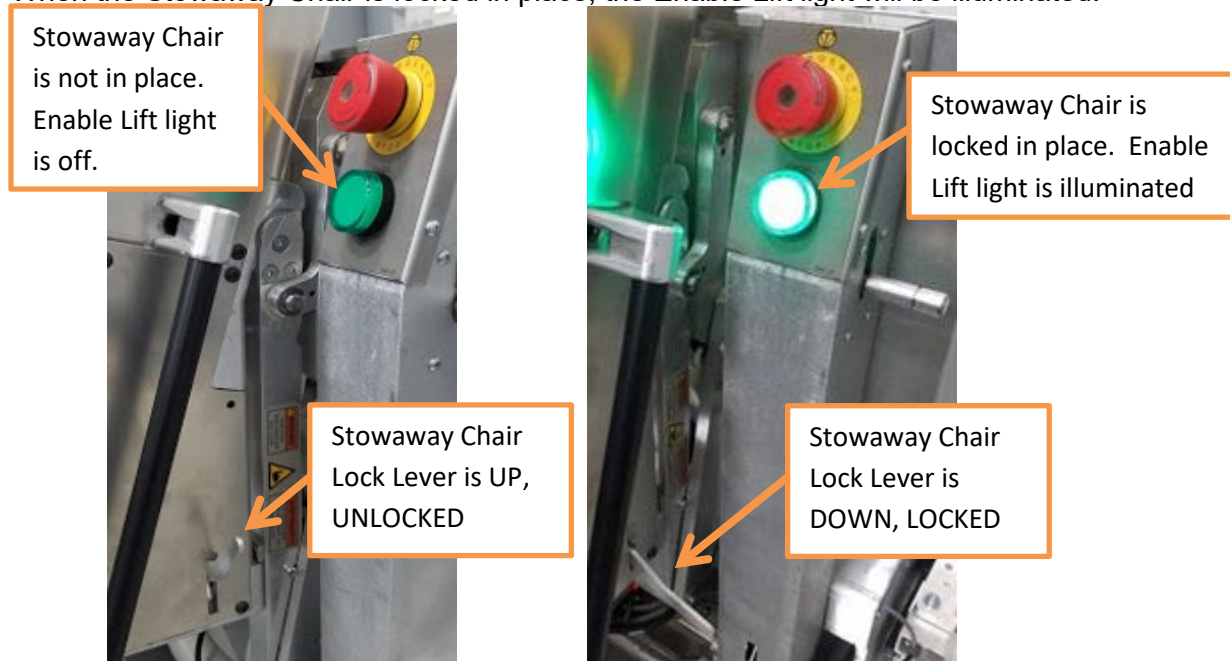

After the Stowaway Chair is in place and the Enable Lift light is illuminated, the Leg Support will need to be attached. Determine which way the patient will be positioned in the chair, for example if the left hand or elbow is to be imaged, the left side of the patient will be against the chair. Patient is then facing the right side of the chair, so the Leg Support would then be needed on the right side of the Stowaway Chair. The Leg Support has three pegs so that it can be flipped upside down for the opposite side. When using, the top two pegs should be inserted into the holes in the tabs on the side of the Stowaway Chair.

Place the TOP two pegs on the Leg Support into the holes in the tabs on the side of the chair as shown below:

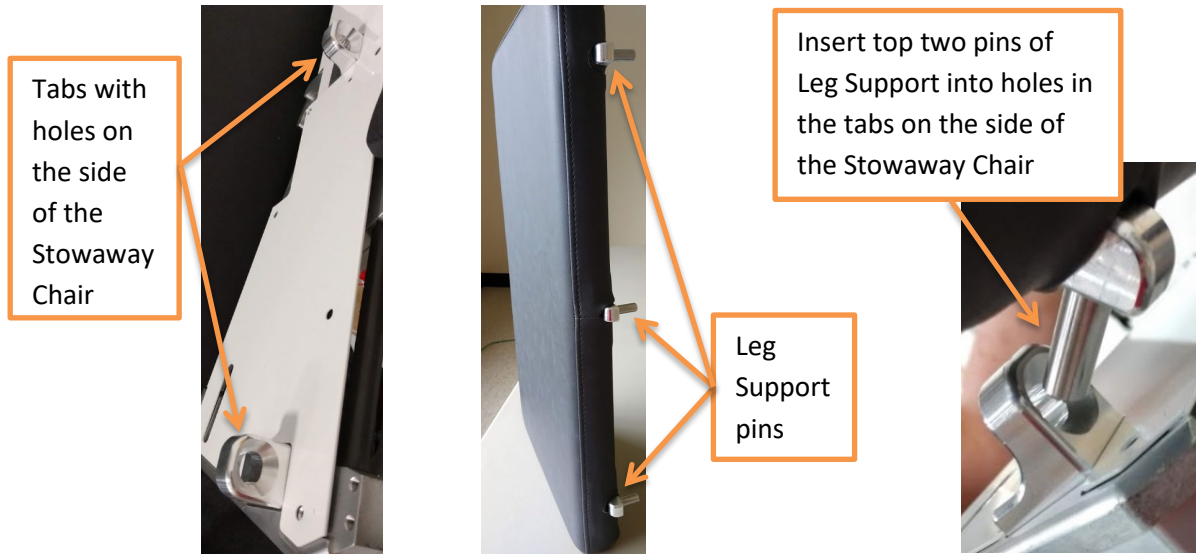

After the Leg Support is attached to the Stowaway Chair ensure the Enable Lift light is still illuminated, then the patient can be positioned in the Stowaway Chair. Have the patient sit with the side that will be imaged closest to the back of the chair. Place the seatbelt around them and lock it. Adjust the head support as needed. The patient will appear as shown:



Utilize the Stowaway Chair Lift Controls to tilt the patient back, so that the body part being imaged can be properly placed in the Field of View. The Stowaway Chair Lift Controls allow for the patient to be tilted into the scanner and to be returned back to the starting position.

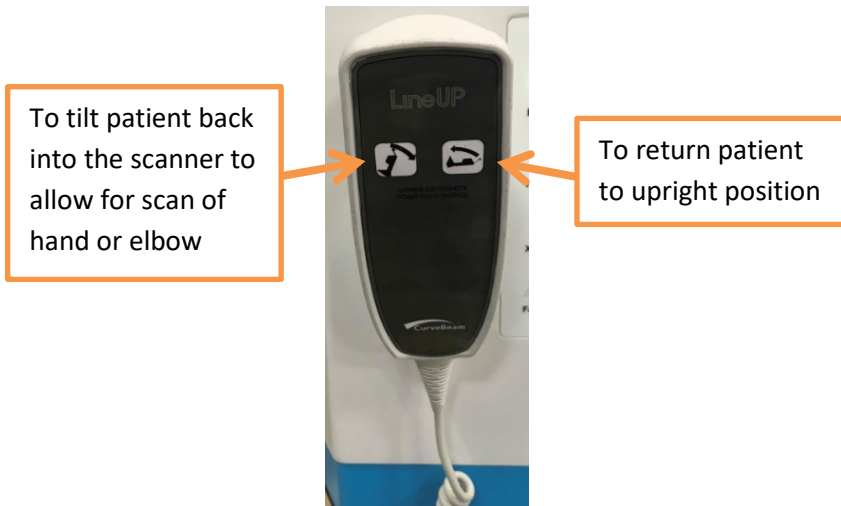

The patient should have their arm placed in the space between the back of the chair and the headrest to allow for positioning against the positioning device in the scanner as shown:



Position the area of interest along the “X-Ray Beam Center” line on the Hand and Elbow Platform. All anatomy inside the outer white trapezoid will be imaged.

Hand Scan:

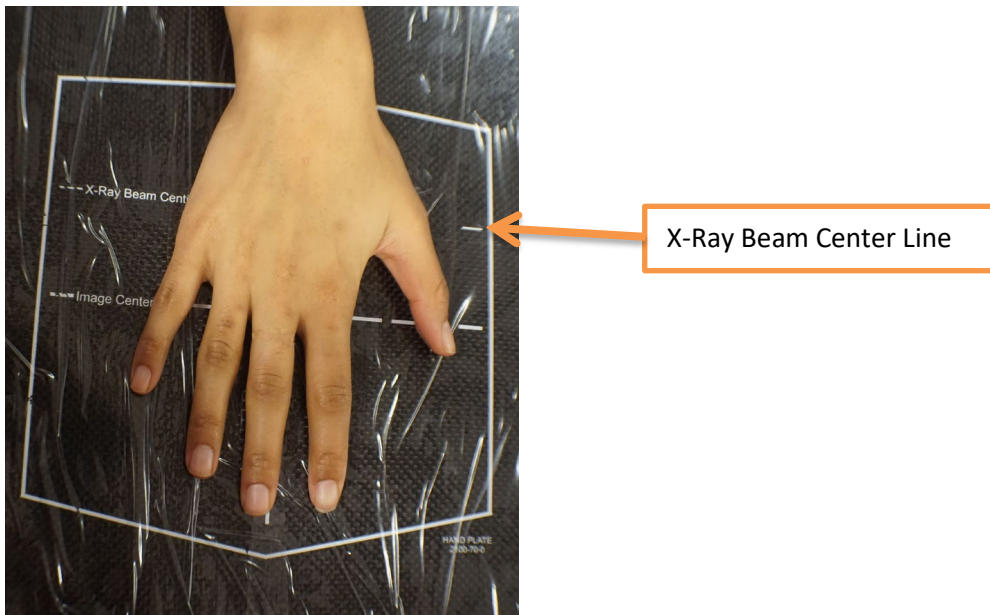

Straight Elbow Scan:



Bent Elbow Scan:

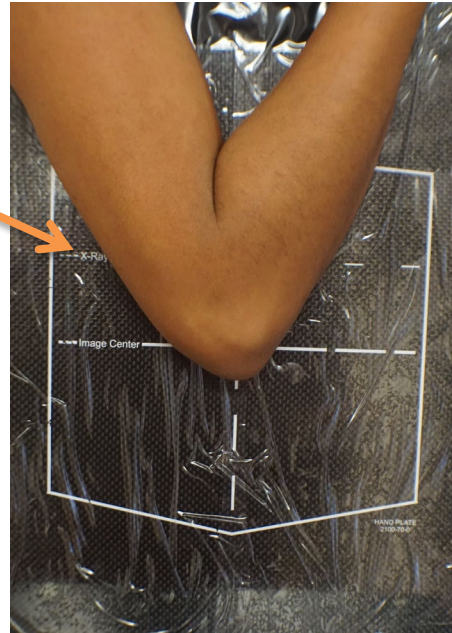

X-Ray Beam
Center Line

Close the Patient Gate once patient is properly positioned.

⚠ WARNING Closing of the Patient Gate creates a pinch point. Keep hands and feet clear when closing Patient Gate

Once the patient scan is done, have the patient bring their arm out of the hole in the back of the chair. Then raise the back of the chair up to the starting position.

Assist the patient in unbuckling the seatbelt and in getting out of the Stowaway Chair. Once the patient is away from the machine, pull UP on the Stowaway Chair Lock Level and the Enable Lift light will turn off.



Enable Lift light is OFF
when Stowaway Chair
is unlocked and able to
be removed

Pull UP on Stowaway
Chair Lock Lever to
unlock and allow for
Stowaway Chair removal

Then holding the side handles on the Stowaway Chair, lift the chair up and away from the Stowaway Frame and set the chair aside. Then locate the Stowaway Frame Release Levers as shown:

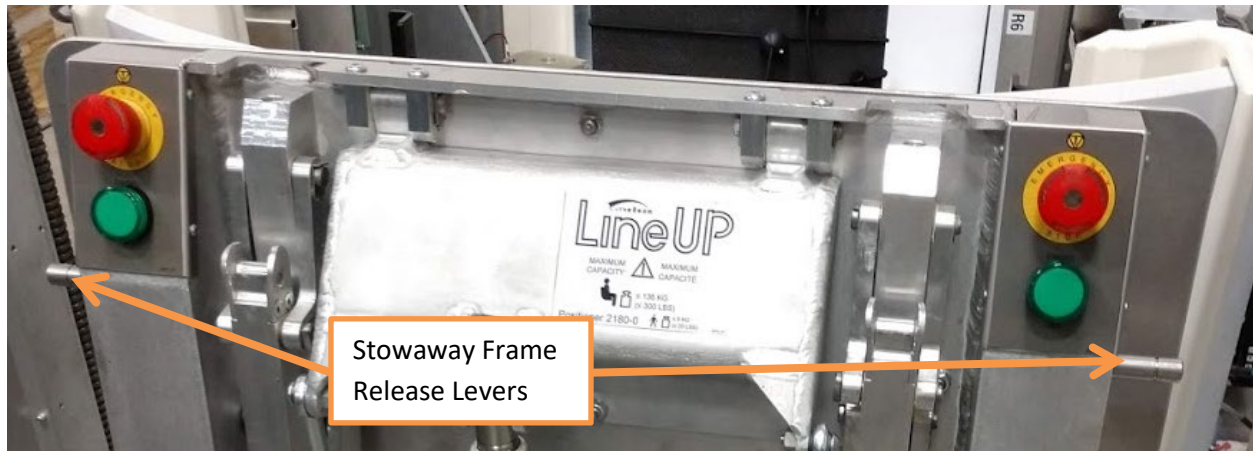

Pull UP firmly on the Stowaway Frame Release levers and then gently pull the Stowaway Frame down and out until it is flat on the floor. Once it is on the floor, slide the Stowaway Frame back under the LineUP Scanner, as shown below:



2D Positioning

2D scans are performed by having the patient place the desired anatomy against the detector. For the Foot and Knee scans, the patient should enter the scanner and hold the hand rails for support. For Hand and Elbow scans, the patient will use the Multi-Extremity Chair, in the same manner as they would for a 3D scan. Positioning instructions are shown below. Gate should be closed after patient is positioned. After scan is acquired, assist patient in safely exiting the scanner.

Weight-bearing Lateral Foot

Position the imaged foot against the detector and position the other foot in front or behind, not in the path of the detector.

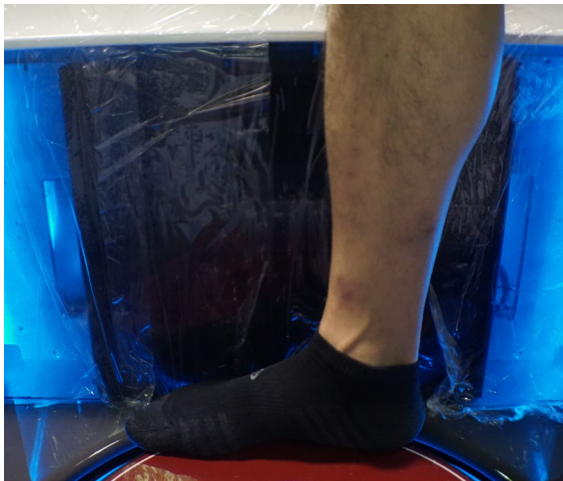

Note: Circular marking lines are not used for 2D positioning. Anatomy should be positioned next to detector inside detector area.

Weight-bearing AP/PA Feet

Position front or back of Both Feet against the Detector.

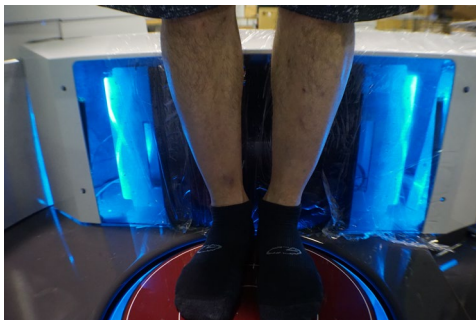

Note: Circular marking lines are not used for 2D positioning. Anatomy should be positioned next to detector inside detector area.

Weight-bearing Lateral Knee

Raise the gantry so that the knee is slightly above vertical center of detector. Position the knee on horizontal center of detector. Place other leg in front or behind, outside of the path of the detector.



Weight-bearing AP/PA Knees

Raise gantry so that knees are slightly above vertical center of detector. Position front or back of knees against the detector.

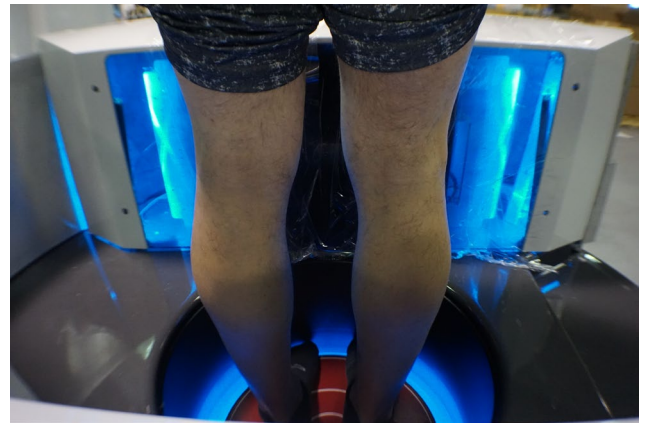
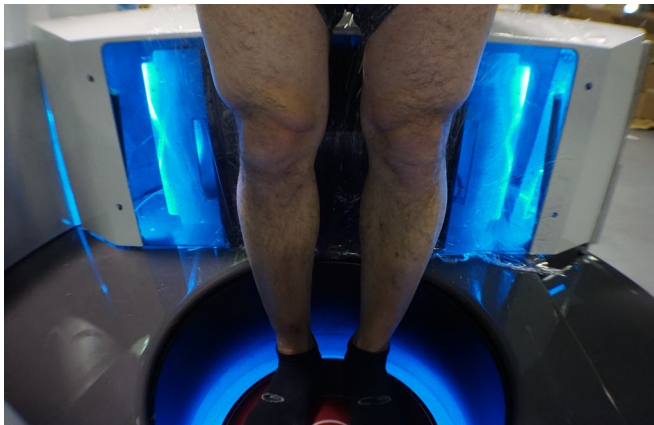

2D Hand

The Multi-Extremity Chair or Multi-Extremity Stowaway Chair should be used as with a 3D Hand scan and pulled out of the machine slightly to position hand against detector with area of interest slightly above center crosshair.

AP Hand Position:



Lateral Hand Position:



2D Elbow

Multi-Extremity Chair or Multi-Extremity Stowaway Chair should be used as with a 3D Elbow scan and pulled out of the machine slightly to position elbow against detector with area of interest slightly above center crosshair.

AP Elbow Position:



Lateral Elbow Position:



APPENDIX I: Troubleshooting

Warning Messages

System failures that may result in a scan failure will be accompanied by Warning Messages in the software. The user should follow the instructions to resolve the error, however if the Warning message persists, the user should contact CurveBeam technical support.

If the system fails to operate in any other way or if your problem is not listed, please contact CurveBeam technical support at the number listed on the front cover.

Message: Another instance of this program is already running.

How to Resolve: This message will appear when a second instance of the software is trying to be opened. If this occurs, close all visible instances of the acquisition software and try to open it again. If this still occurs, then open task manager and end the Acquisition Task.

Message: The system is busy.

Closing the application during an operation can lead to unexpected behavior.

Are you sure you want to terminate the application?

How to Resolve: This message will appear when trying to close the software while it is still working on the last task. Such as closing before the Quality Assurance screen has displayed the image from the last scan. If this occurs, allow the software to finish processing the task it is on, then attempt to close the software.

Message: Please assist the patient in exiting from the machine.

If the gantry is raised around the patient, use the Up/Down Controls to lower the gantry and then assist the patient in exiting the scanner PRIOR to clicking the OK button below. Select OK only after patient is out of the scanner and scanner is clear.

How to Resolve: This message appears when the Cancel button is clicked while in the position patient portion of the scan workflow. If this occurs, it is critical that the operator use the Up/Down controls to lower the gantry down, so that the patient can safely exit the scanner.

Message: Temperature (NonCritical)

How to Resolve: This message appears just to inform the user that the system is functioning properly. The temperature is as it should be. No action is required.

Message: System Calibration was last performed: (date)

Please contact CurveBeam customer support to schedule maintenance.

How to Resolve: Calibrations should be performed annually. If it has been over a year since the system was calibrated, please contact CurveBeam to schedule the annual maintenance for the system.

Message: The following error occurred while scanning:

DOOR_INTERLOCK: Safety interlock was disengaged during the scan.

The application will now close.

How to Resolve: This message will appear if the room door is opened during a scan. The x-ray will terminate and the software will need to close. The patient will need to be rescanned.

Message: The following error occurred while scanning:

SCAN_BUTTON: Scan button was released during the scan.

The application will now close.

How to Resolve: This message appears if the scan button is released while x-ray is firing during a scan. The x-ray will terminate and the software will need to close. The patient will need to be rescanned.

Message: The following error occurred while scanning:

FILAMENT_TIMER: The filament timer expired before the scan completed.

The application will now close.

How to Resolve: If this message appears, assist the patient out of the scanner. Then both the scanner and the acquisition software need to be restarted. To do this, close the acquisition software first. Then reach around to the back of the scanner and turn power off to the scanner. Allow it to wait in the OFF state for about 30 seconds. Then turn the scanner back ON. Then proceed to start up the acquisition software. If the problem persists, please contact CurveBeam technical support.

Message: The following error occurred while scanning:

STALL_DETECT: A gantry stall was detected during the scan.

The application will now close.

How to Resolve: Ensure there is nothing in the path of the gantry. Assist the patient out of the scanner. Then both the scanner and the acquisition software need to be restarted. To do this, close the acquisition software first. Then reach around to the back of the scanner and turn power off to the scanner. Allow it to wait in the OFF state for about 30 seconds. Then turn the scanner back ON. Then proceed to start up the acquisition software. If the problem persists, please contact CurveBeam technical support.

Message: The following error occurred while scanning:

An unknown error occurred during the scan.

The application will now close.

How to Resolve: If this message appears, assist the patient out of the scanner. Then both the scanner and the acquisition software need to be restarted. To do this, close the acquisition software first. Then reach around to the back of the scanner and turn power off to the scanner. Allow it to wait in the OFF state for about 30 seconds. Then turn the scanner back ON. Then proceed to start up the acquisition software. If the problem persists, please contact CurveBeam technical support.

Message: The following error occurred while scanning:

The scanner acquired x out of y expected frames.

The application will now close.

How to Resolve: If this message appears, assist the patient out of the scanner. Then both the scanner and the acquisition software need to be restarted. To do this, close the acquisition software first. Then reach around to the back of the scanner and turn power off to the scanner. Allow it to wait in the OFF state for about 30 seconds. Then turn the scanner back ON. Then proceed to start up the acquisition software. If the problem persists, please contact CurveBeam technical support.

If any “Unhandled Exceptions” or “TimeoutError” occurs while using the scanner.

Both the scanner and the acquisition software need to be restarted. To do this, close the acquisition software first. Then reach around to the back of the scanner and turn power off to the scanner. Allow it to wait in the OFF state for about 30 seconds. Then turn the scanner back ON. Then proceed to start up the acquisition software. If the problem persists, please contact CurveBeam technical support.

APPENDIX II: Scan Protocol Technical Details

LineUP Study Type:	Foot, Knee, Hand, and Elbow Cone Beam CT and Foot, Knee, Hand, and Elbow X-Ray
Scan Positions/Orientations:	Weight Bearing (standing), Seated (partial or non-weight bearing)
CT Scanner make and model:	CurveBeam LineUP
Maximum # of Slices per acquisition:	N/A: System is Volume Cone Beam CT

LineUP has 8 CT Scan Protocol options, which are divided up in the table below, based on the Field of View and kVp values. The description of the Protocols is as follows:

Acquisition series (include all) (i.e., axial, helical)	Medium Field 100 kVp (lite patient)	Medium Field 100 kVp (lite patient)	Medium Field 120 kVp	Medium Field 120 kVp	Large Field 100 kVp (lite patient)	Large Field 120 kVp
Protocol Codes	X-CBCT_DC_100	X-CBCT_UC_100	X-CBCT_DC_120	X-CBCT_UC_120	X-CBCT_DB_100 X-CBCT_UA_100	X-CBCT_DB_120 X-CBCT_UA_120
kVp/mA and rotation time or kVp/mAs	kVp = 100 mA = 5 mAs = 43.2 Rotation time = 23 seconds	kVp = 100 mA = 5 mAs = 28.8 Rotation time = 23 seconds	kVp = 120 mA = 5 mAs = 43.2 Rotation time = 23 seconds	kVp = 120 mA = 5 mAs = 28.8 Rotation time = 23 seconds	kVp = 100 mA = 5 mAs = 43.2 Rotation time = 26 seconds	kVp = 120 mA = 5 mAs = 43.2 Rotation time = 26 seconds
CTDI (vol) required (if on system)	1.745 mGy	1.148 mGy	3.021 mGy	1.972 mGy	DB: 1.730 mGy UA: 1.696 mGy	DB: 2.717 mGy UA: 2.727 mGy
Dose length product (DLP) required if on system	-	-	-	-	-	-

Acquisition series (include all) (i.e., axial, helical)	Medium Field 100 kVp (lite patient)	Medium Field 100 kVp (lite patient)	Medium Field 120 kVp	Medium Field 120 kVp	Large Field 100 kVp (lite patient)	Large Field 120 kVp
Total dose per acquisition and/or total dose per study if available in units given¹	Dose Area Product = 9.92 dGy*cm ²	Dose Area Product = 5.749 dGy*cm ²	Dose Area Product = 16.77 dGy*cm ²	Dose Area Product = 9.313 dGy*cm ²	Dose Area Product DB= 9.437 dGy*cm ² UA= 8.563 dGy*cm ²	Dose Area Product DB= 15.01 dGy*cm ² UA= 14.08 dGy*cm ²
Tube current modulation or dose reduction technique (is used)	12 millisecond pulsed 720 pulses/scan	12 millisecond pulsed 480 pulses/scan	12 millisecond pulsed 720 pulses/scan	12 millisecond pulsed 480 pulses/scan	12 millisecond pulsed 720 pulses/scan	12 millisecond pulsed 720 pulses/scan
Anatomical Scan range (i.e., dome of liver thru pubic symphysis)	- L or R midfoot - L or R midfoot & forefoot	- L or R hand or elbow	- L or R midfoot - L or R midfoot & forefoot	- L or R hand or elbow	- L or R entire foot - Bilateral feet - Bilateral knees	- L or R entire foot - Bilateral feet - Bilateral knees
Increment (space between slices)	0 mm	0 mm	0 mm	0 mm	0 mm	0 mm
Detector collimation (mm)	Fixed 5% of detector, factory calibrated	Fixed 5% of detector, factory calibrated	Fixed 5% of detector, factory calibrated	Fixed 5% of detector, factory calibrated	Fixed 5% of detector, factory calibrated	Fixed 5% of detector, factory calibrated
Slice thickness (mm)	0.31mm +/-0.5mm	0.31mm +/-0.5mm	0.31mm +/-0.5mm	0.31mm +/-0.5mm	0.31mm +/-0.5mm	0.31mm +/-0.5mm
Slice spacing (mm)	0.3mm	0.3mm	0.3mm	0.3mm	0.3mm	0.3mm
Pitch or table feed	0	0	0	0	0	0
Scan FOV (cm)	20 cm diameter x 20.9 cm height	20 cm diameter x 20.9 cm height	20 cm diameter x 20.9 cm height	20 cm diameter x 20.9 cm height	35 cm diameter x 20.9 cm height	35 cm diameter x 20.9 cm height

¹ DAP measurements are performed using the PDC DAP meter from RadCal. The DAP meter is placed directly in front of and up against the receptor panel, facing the x-ray tube output. The requisite scan protocol is performed multiple times. The average of these measurements is reported as the DAP specification for the specific protocol listed in this manual.

Acquisition series (include all) (i.e., axial, helical)	Medium Field 100 kVp (lite patient)	Medium Field 100 kVp (lite patient)	Medium Field 120 kVp	Medium Field 120 kVp	Large Field 100 kVp (lite patient)	Large Field 120 kVp
Kernel/filter	-	-	-	-	-	-
Reformat technique (i.e., 3D, plane/views)	Automatic	Automatic	Automatic	Automatic	Automatic	Automatic
Contrast type/rate (if applicable)	Not Used	Not Used	Not Used	Not Used	Not Used	Not Used
Time from contrast injection to image acquisition, if applicable (sec)	Not Used	Not Used	Not Used	Not Used	Not Used	Not Used

LineUP has 18 X-Ray Protocol options:

Protocol	kVp	mA	ms	mAs	Detector Collimation (mm)
Hand PA Standard	60	5	300	1.5	Fixed 5% of detector, factory calibrated
Hand Lateral Standard	60	5	600	3	Fixed 5% of detector, factory calibrated
Hand PA Lite	60	5	150	0.75	Fixed 5% of detector, factory calibrated
Hand Lateral Lite	60	5	400	2	Fixed 5% of detector, factory calibrated
Elbow AP Standard	60	5	600	3	Fixed 5% of detector, factory calibrated
Elbow Lateral Standard	60	5	600	3	Fixed 5% of detector, factory calibrated
Elbow AP Lite	60	5	400	2	Fixed 5% of detector, factory calibrated
Elbow Lateral Lite	60	5	400	2	Fixed 5% of detector, factory calibrated
Two Feet AP Standard	60	5	800	4	Fixed 5% of detector, factory calibrated
One Foot Lateral Standard	60	5	800	4	Fixed 5% of detector, factory calibrated
Two Feet AP Lite	60	5	500	2.5	Fixed 5% of detector, factory calibrated
One Foot Lateral Lite	60	5	400	2	Fixed 5% of detector, factory calibrated
Two Knees AP Standard	60	5	1300	6.5	Fixed 5% of detector, factory calibrated
Two Knees PA Standard	60	5	1300	6.5	Fixed 5% of detector, factory calibrated
One Knee Lateral Standard	60	5	1200	6	Fixed 5% of detector, factory calibrated
Two Knees AP Lite	60	5	1000	5	Fixed 5% of detector, factory calibrated
Two Knees PA Lite	60	5	1000	5	Fixed 5% of detector, factory calibrated
One Knee Lateral Lite	60	5	750	3.75	Fixed 5% of detector, factory calibrated

APPENDIX III: Pediatric Use Summary

The LineUP is intended to be used on patients ranging from 50 to 400 pounds.

Pediatric use is only intended for CT imaging. Do not use the 2D X-Ray Imaging Feature on pediatric patients.

Introduction: Special care should be exercised when imaging patients outside the typical adult size range, especially smaller pediatric patients whose size does not overlap the adult size range (e.g., patients less than 50 kg (110 lb) in weight and 150 cm (59 in) in height, measurements, which approximately correspond to that of an average 12 year old or a 5th percentile U.S. adult female).

Exposure to ionizing radiation is of particular concern in pediatric patients because: 1) for certain organs and tumor types, younger patients are more radiosensitive than adults (i.e., the cancer risk per unit dose of ionizing radiation is higher for younger patients); 2) use of equipment and exposure settings designed for adults of average size can result in excessive and unnecessary radiation exposure of smaller patients; and 3) younger patients have a longer expected lifetime over which the effects of radiation exposure may manifest as cancer.

To help reduce the risk of excessive radiation exposure, you should follow the ALARA (As Low As Reasonably Achievable) principle and seek to reduce radiation dose to only the amount necessary to obtain images that are adequate clinically.

The LineUP Provides the following specific design features and instructions that enable safer use of our device with pediatric patients:

- a. Page 81 provides recommendations for selecting a protocol appropriate for the patient size
- b. Page 7 advises Patients less than 21 years old and small size patients (under 100 pounds) must also wear a gonad and ovarian front and back protective shield.
- c. Page 9 advises that Patient must wear protective X-ray shielding items (lead apron, etc.) to protect anatomical areas. The patient must wear a protective full wrap X-ray shielding apron (lead apron) during a scan. Patients less than 21 years old, small size patients (under 100 pounds) and children must also wear a gonad and ovarian front and back protective shield.
- d. Pages 107 and 108 provide hand and elbow scan positioning instructions specific to small patients
- e. Testing information
 - i. Estimated dose for all protocols provided in APPENDIX II: Scan Protocol Technical Details
 - ii. Cone Beam CT Performance Testing starting on page 58 has tests for normal size patient (120 kVp) protocols and small patient (100 kVp) protocols
 - iii. Quality Assurance Check Instructions are provided in Chapter 4 and are the same for normal and small patient protocols