

pedCAT™

Computed Tomography Imaging X-ray System



175 Titus Ave, Suite 300

Warrington, PA 18976

Ph: 267-483-8081

Fax: 267-483-8086

info@curvebeam.com

www.curvebeam.com

CurveBeam Technical Support: 267-483-8081

pedCAT™ Table of Contents:

| Chapter | Name | Page |
|---------------|---|------------|
| Chapter 1: | Introduction | 3 |
| Chapter 2: | Product Information | 13 |
| Chapter 3: | Safety Items | 27 |
| Chapter 4: | Calibration & Quality Assurance Procedures | 42 |
| Chapter 5: | Radiation Environmental Survey | 79 |
| Chapter 6: | Operations: Acquiring a Scan | 94 |
| Chapter 7: | Using the Viewing Software: CubeVue | 114 |
| Appendix I: | Installation Instructions | 161 |
| Appendix II: | Troubleshooting | 174 |
| Appendix III: | Scan Protocol Technical Details | 185 |

pedCAT[™] Manual

CHAPTER 1: Introduction

In order to maintain the safety of patient's and operators of this device, it is important to operate and maintain the system correctly, following all instructions, warnings, cautions in this manual and labeling on the system itself. Installation Instructions are detailed in Appendix I.

The PedCAT has been evaluated against European MDD requirements and carries the  ₀₄₇₃ mark.

For technical support or questions contact CurveBeam at 267-483-8081

Warnings, Cautions, Advice, and Notes:

Before attempting to operate the equipment, it is recommended that you read this manual thoroughly including all cautions and warnings. This guide uses the following conventions to describe situations that are potential hazards to the Patient or Operator, potential loss of data, or potential damage to the equipment.

WARNING

Warnings are intended to alert the user that failure to follow the procedure could cause fatal or serious injury to the user, Patient, or any other person, or result in a misdiagnosis.

CAUTION

Cautions are intended to alert the user that failure to follow the procedure could cause damage to the equipment or cause loss of data.

NOTE

Notes are used to highlight important or unusual points to be brought to the attention of the operator.

Advice

Refer to user manual.

Safety Precautions:

 **WARNING** The X-ray device is intended to be used for patients 50 lbs (23 kg) to 400 lbs (181 kg) and groin area at least 22" (56 cm) above the floor. DO NOT use this device for any patient less than 50 lbs (23 kg) OR groin area less than 22" (56 cm) above the floor, whichever is more restrictive.

 **WARNING** The patient must wear a protective full wrap X-ray shielding apron (lead apron) during a scan. Patients less than 21 years old, small size patients (under 100 pounds) and children must also wear a gonad and ovarian front and back protective shield.

 **WARNING** The X-ray device may be dangerous to the Patient and Operator if you do not observe and follow operating instructions. Do not operate this system unless you have received training to perform a procedure.

 **WARNING** Do not remove covers or cables on system. High voltage is present in the system. To avoid personal injury from electrical shock, do not operate the system with any covers open or cables removed.

 **WARNING** This device may cause detrimental interaction with active implantable medical devices and body worn active medical devices. Consult the manufacturer of such devices for more information.

 **WARNING** Closing of the Gate doors creates a pinch point. Keep hands and feet clear when closing Gate.

 **WARNING** No modification of this equipment is allowed.

 **WARNING** Service and maintenance can only be performed by CurveBeam authorized service personnel. ONLY Curvebeam authorized replacement parts can be used in the equipment. These requirements must be followed in order to avoid a hazard to the equipment, operator and/or patient.

 **CAUTION** When initiating an exposure, the external Warning Light is activated a few seconds before the X-ray ON alarm (buzzer) and X-ray ON lights are activated.

 **CAUTION:** Federal law restricts this device to sale by or on the order of a physician.

 **CAUTION:** No auxiliary software should be installed on the system server and thin client terminals.

Electrical Hazards:

Installation and system wiring must meet all requirements of local governing authorities. Please check your local authorities and local codes to determine best practices for a safe installation. Do not place any liquid or food on any part of the consoles or other modules of the system. Observe all fire regulations. Fire extinguishers should be provided for both electrical and non-electrical fires. All operators should be fully trained in the use of fire extinguishers and other fire-fighting equipment and in local fire procedures.

 **WARNING** In the event of an electrical fire, only use extinguishers that are labelled for that purpose. Using water or other liquids on an electrical fire can lead to fatal or other serious personal injury.

 **WARNING** In the event of an electrical fire, to reduce the risk of electrical shock, try to isolate the equipment from the electric source before attempting to extinguish the fire.

 **WARNING** To avoid risk of electric shock, this equipment must only be connected to a supply main with protective earth.

Explosion Hazard

Do not use the System in the presence of explosive gases or vapors, including anaesthetic gases. Use of this system in an environment for which it is not designed can lead to fire or explosion.

 **WARNING** This unit is not suitable for use in a flammable air mixture environment. If hazardous substances are detected while the system is turned on, do not attempt to turn off the system. Evacuate the area and then remove the hazards before turning off the system.

Mechanical Hazards:

 **WARNING** Do not operate the system with any covers open or removed. Operating the system with open or removed covers could expose mechanical operating systems that could cause serious or fatal personal injury to you or the Patient. Only qualified and authorized service personnel should remove covers from the system.

The system is designed to detect that the Gate doors are closed before a scan can initiate. If the gate doors are not closed, then the gantry will not engage and the x-ray will not initiate.

Laser Beam Hazards:

 **WARNING** Laser beams can cause optical damage. The operator should avoid looking directly into the beams. The operator should instruct the patient to avoid looking directly into the beams. The use of optical instruments such as eyeglasses with large diopter or mirrors, increase eye hazard with this product.

Radiation Safety:

X-rays are dangerous to both operator and others in the vicinity unless established safe exposure procedures are strictly observed. Use the following safety measures to ensure safety to the Patient and Operator. The useful and scattered beams can produce serious or fatal bodily injuries to Patients and persons in the surrounding area if used by an unskilled operator. Adequate precautions must always be taken to avoid or reduce exposure to the useful beam or to scattered radiation. Operators are strongly urged to comply with the current recommendations of the International Commission on Radiological Protection and, in the United States, the US National Council for Radiological Protection.

Use the following measures to protect yourself and the patient from unintended exposure to radiation. Anyone who is near the patient during test procedures must observe the following precautions:

- Maintain distance from exposed radiation source in accordance with the facility survey or site plan and shielding designs, provided by a medical physicist. The plan/survey will be created based off of Scatter Measurements provided in this manual. Refer to “typical pedCAT Layout” towards the end of Chapter 5 of this manual for additional details.
- Keep exposure times to a minimum.
- Patient must wear protective X-ray shielding items (lead apron, etc.) to protect anatomical areas. We recommend all patients wear a protective shielding full wrap apron. We recommend that patients less than 21 years old, small size patients (under 100 pounds) and children also wear a gonad and ovarian front and back protective shield. Sample shielding products, or similar:
Supplier: Marshfield, Full Wrap Apron, #MS-SP1
Supplier: Universal Medical Inc, Diaper 14" x 20", #800
- Wear a PEN dosimeter and/or film badge.
- If you are required in the exam room during a procedure, stay as far from the scanner as possible or behind a mobile protective wall.
- The physician is responsible for protecting the patient from unnecessary radiation.

System Safety Devices:

Emergency Stop: In the event of an emergency (any moving component collides with any parts of the equipment or items in the environment, or that could cause physical injury to the Patient), the Operator or Patient should utilize one of the 2 designated Emergency Stop buttons to turn off the power to the X-ray and all moving parts in order for the Patient to be safely removed from the machine. There is an Operator E-stop button on the Operator Control Box and there is a Patient E-Stop button on the machine by the seat. The Emergency Stop (s) when activated will remove ALL power from the machine. If the machine gates are closed, they will have to be opened manually and any obstructions to the patient exit manually removed.

Warning System: The System is equipped with provisions for warning lights and/or audible alarms when X-ray power is energized. An externally powered Warning System can be connected to the cable provided which is capable of 250 volts, 50/60 hertz, and 1 amp. When X-ray power is energized the warning system is also energized.

Interlock System: This System is equipped with provisions for an Interlock Circuit which, when opened, will turn off X-ray power. This is a low voltage circuit, 5 volts DC. To use the Interlock Circuit disconnect the factory installed Shorting Plug. Connect the supplied Interlock Cable to the scanner. Connect door switches (NO/COM terminals) and/or emergency stop switches (NC/COM terminals) in series between the other end of the Interlock Cable wires. Multiple door switches and/or emergency stop switches can be connected as long as the devices are connected in series. The entire circuit must be a closed loop when all of the doors are closed and/or emergency stop switches are in their normally closed state.

Whenever the door switch or switches are opened or emergency stop button(s) pressed the X-ray power will be turned off. X-ray power cannot be turned on when the interlock circuit is open.

Interlock and Warning System Schematic:

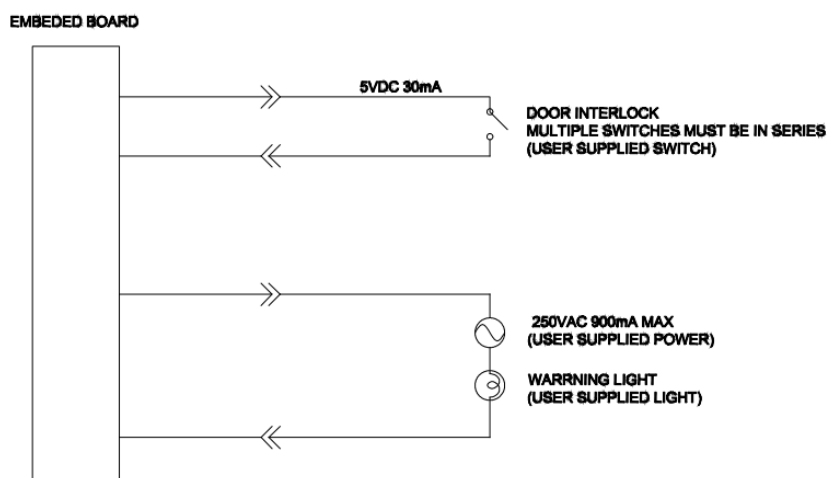

Patient Preparation Recommendations:

We recommend the patient wear FDA approved medical gloves for gripping the hand rails, with sanitation and convenience in mind.

We also recommend the patient not step bare foot on the patient platform. Proper foot protection should be provided.

After each patient scan, clean and disinfect all items which come in contact with the patient.

Cabling Requirements:

System cabling connections must be installed away from walkways and doorways. It is recommended to run cabling along wall perimeters. If there is a chance of mechanical damage due to the cable location, then the use of conduit or other means of protection should be considered.

Emergency Removal of a Patient:

The system has undergone extensive testing of the mechanical, electrical and software performance, but if an unexpected occurrence is observed and/or the software locks up during a scan or an emergency arises where it becomes necessary to interrupt a scan and/or remove a patient from the system before a scan is completed, please follow these steps:

1. Press the EMERGENCY STOP button. This will halt the X-ray as well as the motors to the machine functions and all power to the machine. The message below will display on screen and will terminate the “CB Scanning Device” Acquisition software:



2. Open the Gate doors manually with your hands by using the slots at the top of each door to grasp and slide to an open position. Manually rotate the gantry out of the way if needed.
3. Carefully assist the patient to step out of the scan platform area.
4. Reset the machine: Close the PedCAT Acquisition, “CB Scanning Device” software (if not already). Release the E-stop by turning the knob to the right until it pops up. Then turn the machine power back ON at the Main Circuit Breaker. Re-launch the PedCAT Acquisition “CB Scanning Device” software. Now the system can be operated again as expected.

System Description

The PedCAT is a Computed Tomography X-ray system or Cone Beam Volumetric Tomography x-ray system for 3D reconstruction Imaging device for the foot and ankle. The system is designed for an in-office setting with components consisting of the Scanner, Operating Computer (External Server), Operator's Console and Viewing Console. The system provides for patient's to be imaged in weight bearing (standing) position as well as seated position for one or both feet.

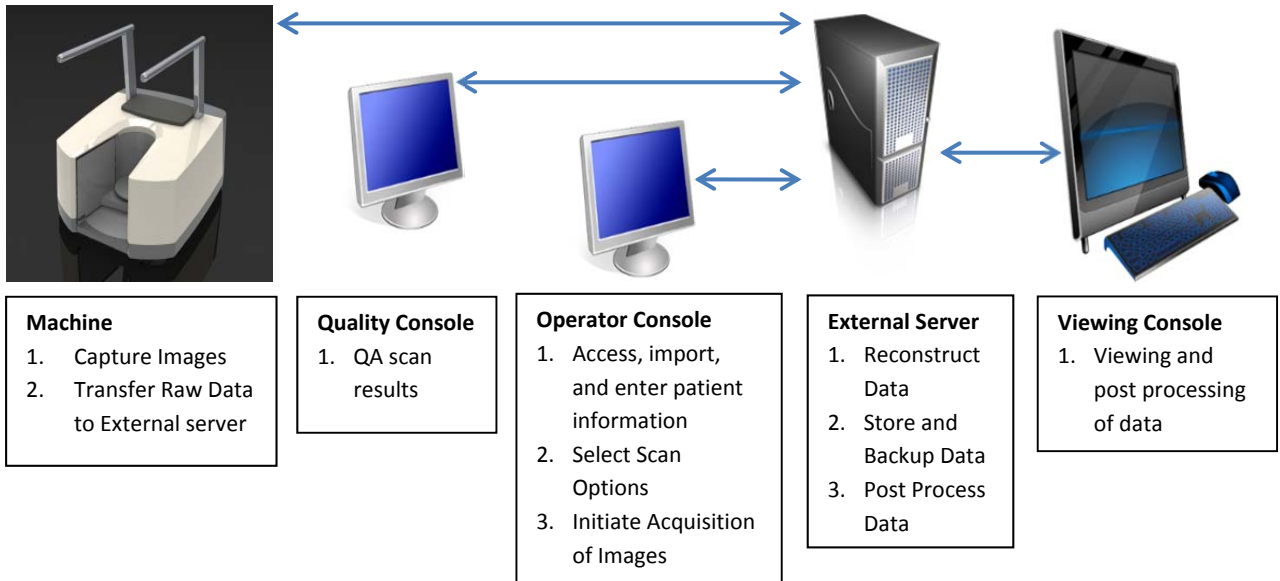

The External Server consists of 4 Virtual Machines:

ACQ VM: accessed via the Main Desktop icon on the ACQ thin client terminal

Viewing Station/MD VM: accessed via the Main Desktop icon on the QCW thin client terminal or the QA Station thin client terminal.

RECON VM: accessed via the Remote Desktop Connection icon on the ACQ thin client terminal.

Database VM: accessed via the Remote Desktop Connection icon on the ACQ thin client terminal.

Major Device Components:

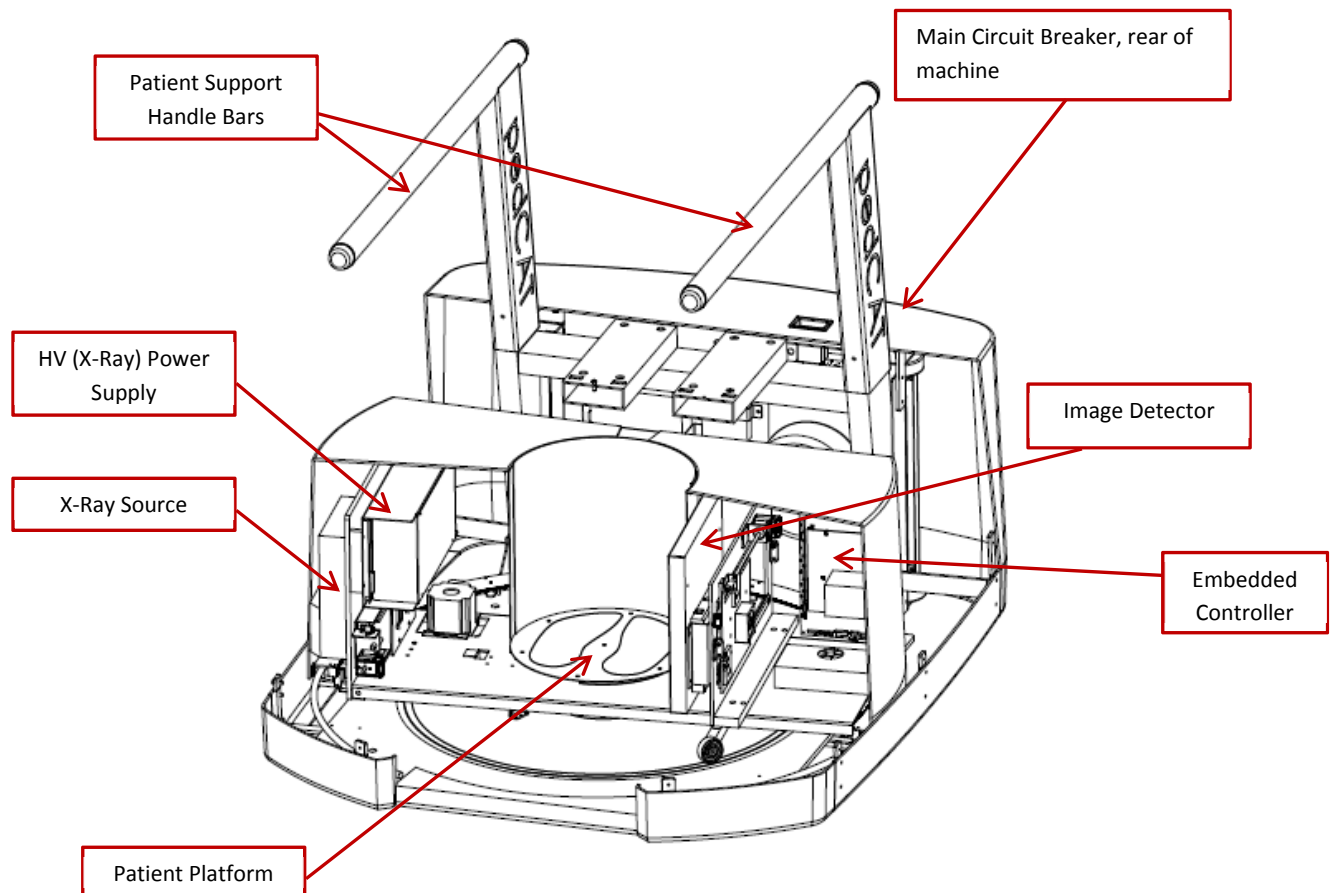

Intended Use of the Device:

The PedCAT is intended to be used for 3-D imaging of the foot & ankle region, to visualize and assess the osseous and certain soft tissue structures, including joint spaces, bone angles and fractures. This modality is anticipated to be applicable to pediatric* cases as well as adults*, when appropriate diagnosis of a given foot condition is considered necessary.

* Patient parameters: 50 lbs to 400 lbs
Groin area at least 22" above the floor

Major System Items:

- Scanner
- Dell server with hard drives, network cards, DVD drive, etc and Uninterrupted Power Supply (UPS)
- External Cable Kit
 - Door Interlock, 50' (15.24 m)
 - Warning System, 50' (15.24 m)
 - Door interlock, shorting plug
 - Operator Control Box Assembly, 50' (15.24 m)
 - Exposure/Scan Switch Assembly, 10' (3.05 m) coil cord
- Ethernet Cable, CAT6, gray, 50' (15.24 m) (QTY 2)
- Ethernet cable, CAT 6, green, 50' (15.24 m)
- Ethernet cable, CAT6, red, 50' (15.24 m)
- Power cord, 10' (3.05 m)
- Varian Panel, 3030D
- X-Ray tube assembly
- HV power supply

About the Operators' Manual:

This documentation describes the safe and effective operation of the system. The information is intended to provide trained Technologists and Physicians the necessary guidance to operate the system in a safe and effective manner.

CurveBeam assumes no liability for the use of this document if any unauthorized changes to the content or format have been made.

Conventions Used in the User Manual:

Main Menu items and Tabs are in quotes (" "). Software Programs are in quotes (" ")

Interface buttons are capitalized" (BUTTON).

Standard Limited Warranty

CurveBeam, LLC warrants the original purchaser that this hardware system will be free from defects for a period of one (1) year from the date of delivery. During the warranty period, CurveBeam, LLC will correct any defects in material or workmanship, at no charge for material, labor or travel. Any replacement parts shall be new or serviceable used parts and are warranted for the remainder of the original warranty or thirty (30) days, whichever is longer. This original warranty includes software maintenance upgrades*, but excludes new optional application modules or major new features. Also included in the warranty is free telephone consultation which will be furnished without charge by CurveBeam LLC. Data back-up is not covered and is the customer's responsibility.

* CurveBeam, LLC reserves the right to determine which software upgrades are included in the warranty.

The warranty period is not extended as a result of purchasing any additional parts from CurveBeam, LLC. The original purchaser must promptly notify CurveBeam, LLC in writing if there is a defect in material or workmanship. Written notice in all events must be received by CurveBeam, LLC before expiration of the warranty period. This warranty is not transferable. This One-Year Limited Warranty covers normal use.

CurveBeam, LLC does not warrant or cover the following:

- Damage caused by impact with other objects, dropping, falls, spilled liquids or immersion in liquids
- Damage caused by a disaster such as fire, flood, wind, earthquake, or lightning
- Damage caused by unauthorized attachments, alterations, modifications or foreign objects
- Damage caused by failure to provide a suitable operating environment
- Damage caused by the use of the hardware system for purposes other than those for which it was designed
- Damage from improper maintenance performed by other than OEM trained personnel
- Damage from improper electrical connection or supply
- Damage caused by any other abuse, misuse, mishandling, or misapplication
- Damage to internal or external computer, software, or operating system caused by:
 - Unauthorized additions or changes, Viruses, spyware or gaming software
 - Applications other than its intended use
 - Damage caused by third party software or damage caused by unauthorized changes to the system software
 - Damage caused by unauthorized upgrades, additions, deletions or unnecessary internet use, or any other unauthorized application.
- Under no circumstances shall CurveBeam, LLC be liable for any special, incidental, or consequential damages based upon breach of warranty, breach of contract, negligence, strict liability or any other legal theory. Such damages include, but are not limited to, loss of data, loss of profits, loss of revenue, loss of use of hardware system or any associated equipment, cost of capital, cost of substitute or replacement equipment, facilities or services, down time, purchaser's time, the claims of third party, including customers, and injury to property.

Disclaimer of Warranties The warranty stated above is the only warranty applicable to this product, all other warranties, expressed or implied including all implied warranties of merchantability or fitness for a particular purpose, are hereby dis-claimed. No oral or written information or advice given by CurveBeam, LLC, its agents or employees shall create a warranty or in any way increase the scope of this warranty.

CHAPTER 2: Product Information

Technical Specifications:

| Description | Specification |
|--|--|
| Tube voltage | 100 kVp, 120 kVp, (+/-10%) |
| Tube current | 5 mA, (+/-10%) |
| CBCT Scan time* | 16-32 sec |
| CBCT Procedure time** | Medium Field: 50 sec, Large Field: 104 sec |
| Max exposure time (based on typical pulse width) | 10 sec |
| Image detector | Amorphous Silicon flat panel |
| Gray scale | 14 bit |
| CBCT Imaging Volume | 7.9" (20 cm) high x 13.8" (35 cm) diameter, 7.9" (20 cm) high x 7.9" (20 cm) diameter |
| Typical slice thickness/voxel size | 0.3 mm voxel, 0.37 mm voxel |
| Measurement accuracy | ± 2 voxel |
| Body part scanned | Foot and ankle |
| Size of system: h x d x w | 47"x59"x48" (119.4 cm x 149.9 cm x 121.9 cm) |
| Weight | 400 lbs (181.8 kg) |
| Power Requirements | 1150VA |

*Scan time is defined as the duration in which the exposure alarm (buzzer) is ON and X-ray ON light is illuminated.

**Procedure time is from time the exposure button is pressed to when the doors open completely after the scan.

X-ray Source:

Tube Voltage: 100 kVp(eff), 120 kVp(eff), +/- 10%

Tube Current: 5 mA, +/- 10%

Voltage Wave Shape: Constant Potential

Focal Spot: 0.0197 inches (0.5 mm)

Duty Cycle: 3%

Source to Sensor distance: 28.896" (73.39 cm)

Source to Patient distance: 21.095" (53.58 cm*)

*The patient must be properly positioned for each patient for all applications in order to have the focal spot to skin distance as large as possible.

Minimum Filtration (at 120 kVp(eff)) (mm of aluminum equivalent): 10 mm or greater

Maximum Rated Continuous Tube Operation: 130 kVp @ 0.5 mA

Maximum Rated Pulsed Tube Operation: 130 kVp @ 5mA

✓ NOTE: Leakage technique factors are measured at the maximum specified energy.

Timer: ± 0.1 seconds or 5%, whichever is greater

X-ray Beam Size: 2 Rectangular: 11.8" (30 cm) wide x 11.8" (30 cm) high, 5.9" (15 cm) wide x 5.9" (15 cm) high

Image Detector: Amorphous Silicon Flat Panel (readable area): 11.8" (30 cm) height x 11.8" (30 cm) width.

Sensor Front Panel Attenuation Value: Less than 1mm of aluminum equivalent (information for reference only)

Gray Scale: 14 bit

Voxel Size: 0.3/0.37

CBCT Image Acquisition: 1 or 2 orbits, 360 degree rotation (maximum)

CBCT Field of View: 7.9" (20 cm) diameter x 7.9" (20 cm) height (1/2 or 1 orbit)

CBCT Extended Field of View: (offset scan): 13.8" (35 cm) diameter x 7.9" (20 cm) height (2 orbits)

CBCT Procedure Times: 50 sec for 20 x 20, 104 sec for 35 x 20

Patient Protocol options available for scanning:

| Patient Parameters | Exposure Factors | Type |
|---|-------------------------|--|
| <i>Small Size:</i> Weight: 50 to 100 lbs (23-45 kg), Height: Groin area at least 22" (56 cm) above the floor. | 100 kVp, 5mA | Small Patient: Medium Field (100kVp) |
| <i>Small Size:</i> Weight: 50 to 100 lbs (23-45kg), Height: Groin area at least 22" (56 cm) above the floor. | 100 kVp, 5mA | Small Patient: Large Field (100kVp) |
| Weight: 101 to 400 lbs (46-181 kg), Height: Groin area at least 22" (56 cm) above the floor. | 120 kVp, 5mA | Large Field (120kVp) |
| Weight: 101 to 400 lbs (46-181 kg), Height: Groin area at least 22" (56 cm) above the floor. | 120 kVp, 5mA | Medium Field (120kVp) |
| Weight: 101 to 400 lbs (46-181 kg), Height: Groin area at least 22" (56 cm) above the floor. | 120 kVp, 5mA | Medium Field, Sharp Filter (120kVp) |

Minimum patient size parameters:

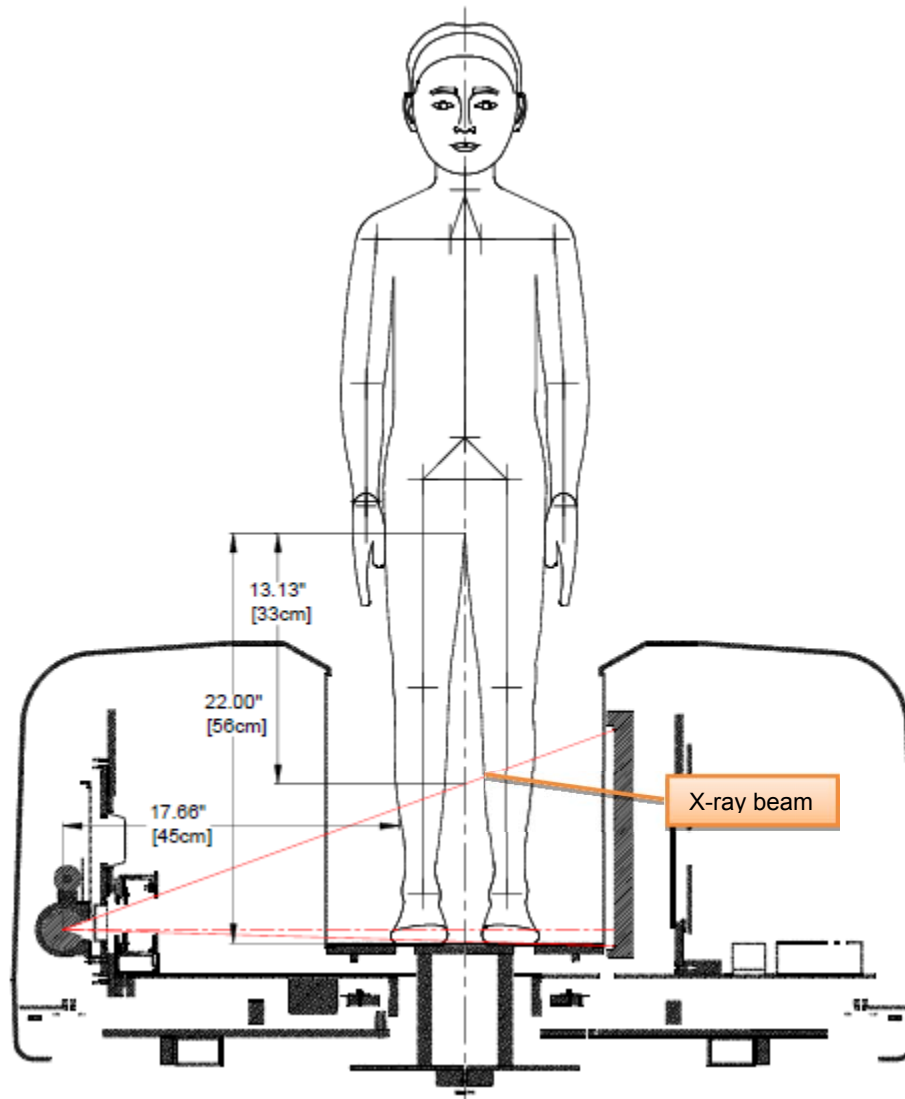

CBCT Primary Reconstruction:

- **Medium Field of View options:** Maximum 2 minutes
- **Large Field of View options:** Maximum 3 minutes

CBCT Secondary Reconstruction: Real Time

Gantry Stopping Distance and Angle: Total rotation from Home position to limit is 424 degrees (Home being 0 degrees). "Load" position (gantry aligned for patient to walk in) is 25 degrees from home position.

Power Requirements:

The Scanner requires a Dedicated Line and/or Filtered Line. A Surge Protector is recommended. The Scanner is suitable for continuous connection to a power supply in stand-by mode.

Line Voltage: 100VAC, 115VAC, 200VAC all \pm 10% (Factory Set)

210 to 240VAC (which covers 220, 230 and 240 VAC power supplies) (Factory Set)

Line Current: 10 Amps (100V), 10 Amps (115V), 5 Amps (200V) or 5 Amps (230V)

Line Frequency: 50 Hz / 60 Hz

Phase: Single

Main Circuit Breaker: 10 Amps (100V), 10 Amps (115V), 5 Amps (200V), or 5 Amps (230V)

Nominal Electrical Input Power to Supply: Volume Scan = 300W (120kV, 5mA); Scan Time has no effect on electrical power output.

Apparent Resistance of Supply Mains:

For the purpose of obtaining the apparent resistance of supply mains, resistance is determined according to the following formula:

$$R = \frac{U_0 - U_1}{I_1}$$

Where:

U₀ is the no-load Mains Voltage

U₁ is the Mains Voltage under load.

I₁ is the Mains Current under load.

| Circuit Breaker Assembly | U ₀ | U ₁ | I ₁ | Apparent Resistance |
|--------------------------|----------------|----------------|----------------|---------------------|
| 100VAC | 100VAC | 98.8VAC | 2.5A | 0.48ohms |
| 115VAC | 115.4VAC | 114.2VAC | 2.1A | 0.57ohms |
| 200VAC | 200.4VAC | 198.1VAC | 1.3A | 1.77ohms |
| 230VAC | 230.8VAC | 228.0VAC | 1.2A | 2.33ohms |

Environmental Specifications:

Operating:

- The operational temperature range shall be 59°F to 86°F (+15°C to +30°C).
- The operational humidity range shall be 25 to 60% relative humidity, non-condensing.
- The minimum time period that the room environmental operating conditions must be maintained prior to powering the system is 1 hour.

Transportation and Storage:

- The storage and transport temperature range shall be -4°F to 122°F (-20°C to +50°C).
- The storage & transport humidity range shall be 10% to 95% relative humidity, non-condensing.

Scanner and Acquisition Computer (server):

- Requires a Dedicated Line and a Surge Protector is recommended.

Patient Platform:

- Maximum patient weight capacity: 400 lbs. (181kg)

Patient Seat:

- Maximum patient weight capacity: 300 lbs. (136kg)

Handle Bars:

- Maximum weight capacity: 150 lbs. (68kg)

Disposal:

Follow local regulations on disposal of waste parts. The *X-ray source assembly, image sensor and all electronic circuits* should be regarded as non environmental friendly waste product. The system does not generate, or require the use of, any materials that require special disposal instructions as part of regular operation.

Extension Cords:

Do not use any extension cords which are not provided with the system. Be aware that multiple portable socket outlets or extension cords are not to be connected to the system.

External Items:

Do not connect any items or equipment to this system which are not part of the system.

Electromagnetic or other Interference (Emissions and Immunity):

The system was tested and it was determined to meet the class A (non-residential) limits. The system pass testing with a reduced level of compliance with the criteria contained in IEC 60601-1-2 Edition 3 Issued 03/2007.

| Test Name | Test Level/ Equipment Class | Results/Notes | Immunity Performance Criteria Met |
|--|--|-----------------------------|---|
| Emissions Testing | | | |
| Radiated Emissions | Class A: Group 1 | Compliant | - |
| Conducted Voltage Emissions | Class A: Group 1 | Compliant | - |
| IEC61000-3-2 Harmonic Current Emissions | Class A | Compliant | - |
| IEC61000-3-3 Voltage Changes, Voltage Fluctuations and Flicker | Class A | Compliant | - |
| Immunity Testing | | | |
| 61000-4-2 Electrostatic Discharge | ±6 kV Contact, ±8 kV Air | Compliant | A |
| 61000-4-3 Radiated Immunity | 80 MHz – 2.5 GHz, 3 V/M, 80% AM with 1kHz | Compliant | A |
| 61000-4-4 Electrical Fast Transients | ±1 kV Power Supply Lines, ±1 kV Input/Output Lines | Reduced Level of Compliance | A |
| 61000-4-5 Surge Immunity | ±1 kV Line to Line, ±2 kV Line to Earth | Compliant | A |
| 61000-4-6 Conducted Immunity | 150 kHz – 80MHz, 3 Vrms | Compliant | A |
| 61000-4-8 Power Frequency Magnetic Field | 3 A/M | Compliant | A |
| 61000-4-11 Voltage Dips and Short Interruptions | >95% dip for 0.5 periods | Compliant | A |
| | 60% dip for 5 periods | Compliant | A |
| | 30% dip for 25 periods | Compliant | A |
| | >95% dip for 5 seconds | Compliant | C |

 **WARNING** This system is intended for use by healthcare professionals only. This system may cause radio interference or may disrupt the operation of nearby equipment. Follow the following recommendations below.

Recommended separation distances between portable and mobile RF communications equipment and the PedCAT

The PedCAT is intended for use in an electromagnetic environment in which radiated RF disturbances are controlled. The customer or the user of the PedCAT can help prevent electromagnetic interference by maintaining a minimum distance of 10 feet (3 m) between portable and mobile RF communications equipment (transmitters) and the PedCAT. Refer to the portable and mobile RF communications equipment user's manual for recommended clearance distances to other equipment based on the maximum output power of the communications equipment. Maintain a minimum distance of 10 feet (3m) between the PedCAT and portable and mobile RF communication equipment.

Equipment Standards:

The PedCAT has been designed and evaluated to meet the requirements of the following standards. The device has passed all applicable sections of these standards.

| | |
|--|---|
| IEC 60601-1, third edition, 12/2005 | IEC 60601-1, second edition, 12/1995 |
| IEC 60601-1-2, third edition, 03/2007 | |
| IEC 60601-1-3, second edition, 01/2008 | IEC 60601-1-3, first edition, 01/1994 |
| IEC 60601-1-6, third edition, 01/2010 | IEC 60601-1-6, first edition, 01/2006 |
| IEC 60601-1-8, second edition, 10/2006 | IEC 60601-1-8, first edition, 1/2003 |
| IEC 60601-2-7, second edition, 02/1998 | |
| IEC 60601-2-44, third edition, 02/2009 | IEC 60601-2-44, second edition, 01/2002 |
| IEC 62304, first edition, 05/2006 | |
| ISO 15223-1:2012 | |
| ANSI/AAMI ES60601-1, third edition, 01/2005 | |
| CSA C22.2 NO. 60601-1:08-CAN/CSA, third edition, 07/2008 | |
| BS EN ISO 14971:2009 | |
| EN ISO 15223-1:2012 | |
| BS EN 1041:2008 | |

The PedCAT conforms to the provisions of MDD 93/42/EEC (as transposed into national law in the United Kingdom through Statutory instrument SI 618 2002 Medical Device Regulations 2002 and as amended by SI 2008 No. 2936).and Australian Medical Device Directives, TGA , v1.1, May, 2011

Equipment Class:

- Protection against electric shock: Class I
- Applied part has degree of protection against electric shock: Class B
- Class of equipment against ingress of liquids: Ordinary Equipment: IPX0
- Radiated emissions: Class B

Regulatory Class:

| Governing Body | Classification |
|-------------------------------------|-----------------------|
| FDA | 2 |
| Health Canada | 3 |
| Medical Device Directive(93/42/EEC) | IIb |

Cleaning:

Routinely and after each patient scan, clean and disinfect all items which come in contact with the patient.

Cleaning the equipment frequently, especially if corroding chemicals are present is a function of the Operator. Unless otherwise instructed, use a cloth **moistened** with warm water and mild soap. Do not use strong cleaners and solvents as these may damage the finish. Be careful when cleaning to avoid liquid leaking underneath the Platform Area and into the Gantry. DO NOT USE WATER ON THE IMAGE RECEPTOR, this should only be dusted with a dry cloth.

For disinfecting, use Biocide ® from Biotrol International or equivalent cleaner and disinfectant. Biocide® is an Iodophor formulation that kills HIV, Tuberculosis and Polio in 10 minutes. Moisten a cloth with the disinfectant and then wipe down the area. Do not spray disinfectant directly onto the equipment.

Preventive Maintenance Schedule - for Owner / User:

- *Daily:*

Routine Dusting - all surfaces.

Clean and Disinfect all items which come in contact with the patient after each patient scan.

- *Monthly:*

Clean/Disinfect all surfaces, check for failed/faulty indicator lights.

- *Quarterly:*

Perform Panel Calibration (Gain, Air)

- *Yearly:*

Check for satisfactory image quality.

IT IS THE RESPONSIBILITY OF THE USER TO INSURE THAT THE EQUIPMENT IS MAINTAINED IN COMPLIANCE WITH THE MANUFACTURER'S RECOMMENDED MAINTENANCE SCHEDULE. THE MANUFACTURER AND THE ASSEMBLER / INSTALLER ARE RELIEVED FROM RESPONSIBILITY IN THOSE CASES WHERE NON-COMPLIANCE WITH THE STANDARD RESULTS FROM THE USER'S FAILURE TO HAVE THE MANUFACTURER'S RECOMMENDED MAINTENANCE PERFORMED.

The actual maintenance inspection and consequent service must be accomplished either by an authorized factory trained technician or by a competent serviceman of the user's choice who has adequate training in those aspects of the Performance Standards of the Radiation Control for Health and Safety Act of 1968 that are applicable to this equipment. Neither the inspection nor service is part of the equipment warranty. (To be arranged for by the Owner or User with the Dealer's Service Department).

Planned Maintenance – Monthly Schedule:

The system requires monthly maintenance check for failed or faulty indicators/lights.

1. Procedure for checking for failed or faulty indicators/lights. If any of the below do not behave as expected, then please contact CurveBeam Technical Support at the number on the front cover of this manual.

CB-Tools Program:



- From the ACQ Desktop area, click on the CB-Tools icon. This icon will open the interface required for the checks.
- **WARNING LIGHT:** In this interface, first click on **WARNING LIGHT TEST** button. If your system has a warning light installed, then the **WARNING LIGHT** should turn **ON**. If the warning light does not function check the electrical connections, power and indicator lights/audible alarms for proper operation. If the warning system components are found functional then contact CurveBeam Technical Support.

- **DOOR INTERLOCK:** Next, if you have a Door Interlock, first close the X-ray Room Door. Click on the DOOR INTERLOCK TEST button. If functioning properly, then a message will appear indicating so. Then Open the X-Ray Room Door and click on the DOOR INTERLOCK TEST button again. The message should indicate that the Door is opened and no x-ray can be taken at this time.
- **EXPOSURE:** This will check the Exposure Switch, audible exposure sound and both visual X-Ray ON indicator lights. Click on the EXPOSURE TEST button. An instruction should display asking to “Push and hold down the exposure button”. Hold down the exposure switch for the duration of the exposure, which should be approx. 5 seconds. Observe for the audible sound and that the X-ray ON lights on the machine and the operator’s control box are illuminated in Amber color during this exposure.
- **EMERGENCY STOP:** Exit the CB-Tools program by clicking on the X in the upper right corner. With the machine Main Circuit Breaker in the ON position, Power Light ON, press the EMERGENCY STOP button. The Main Circuit Breaker should trip. Release the EMERGENCY STOP by turning the knob to the right until it pops up. Turn the Main Circuit Breaker to the ON position and re-launch the PedCAT ACQ Software.

Planned Maintenance – Quarterly Schedule:

The system requires quarterly maintenance check for Panel Calibration. This can be performed by the end user with CurveBeam Technical Support if necessary.

1. The procedure for the panel calibration is in the section under **Calibrations:**
Panel for Gain & Air Calibration.

 **Advice:** Please refer to that section for instructions on performing this procedure. (Chapter 4: Calibration & QA Procedures).

If panel calibrations are not routinely performed, there may be suboptimal image quality. The scan results may have symptoms of artifacts commonly referred to as “circle or ring artifacts”. Below are samples of circle artifacts in scan results. If these are observed than a panel calibration should be performed.

 **Advice:** Please refer to Chapter 4 and also contact CurveBeam Technical Support.

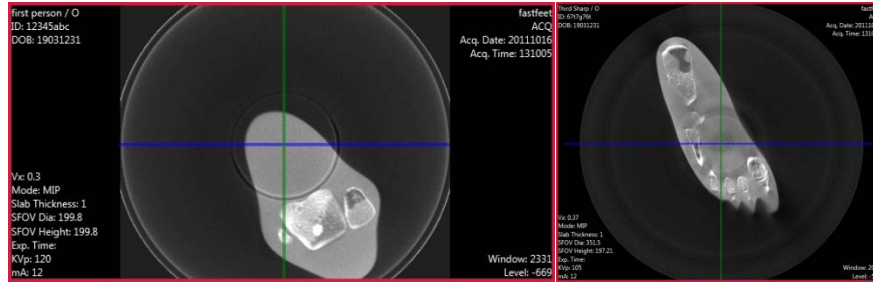

UPS (Uninterruptible Power Supply) Maintenance:

Please refer to the Dell Line-Interactive Rack UPS (1000W, 1920/1500W and 2700/2300W) User's Guide for UPS maintenance recommendations.

Planned Maintenance - Annual Schedule:

The system requires normal periodic inspection and maintenance. Scheduled periodic inspections are necessary to detect problems which can result from excessive wear, loose items, chafing wires, and mis-adjusted parts from continual system use. In addition to mechanical inspection and calibration, a series of image performance tests are to be conducted. Planned maintenance is to be performed annually by a factory trained Service Technician. If there are any questions regarding the annual maintenance, please contact CurveBeam Technical Support.

Replacement Parts:

| Part Description | Part Number |
|---------------------------------|-------------|
| Gantry Belt | 200104 |
| Rotation Motor | 100109 |
| Beam Limiter Motor | 100112 |
| Receptor Motor | 100110 |
| Door Motor | 100111 |
| Breaker Switch Assembly 100 VAC | 4002-100-0 |
| Breaker Switch Assembly 115VAC | 4002-115-0 |
| Breaker Switch Assembly 200VAC | 4002-200-0 |
| Breaker Switch Assembly 230VAC | 4002-230-0 |
| X-Ray Power Supply Assembly | 4003-0 |
| Embedded Board Assembly | 4004-0 |
| Can Bus Breakout Assembly | 4006-0 |
| 120VAC Breakout Assembly | 4007-0 |
| LED Distribution Assembly | 4008-0 |
| X-Ray Tube head | 2007-0 |
| Image Receptor (Panel) | 100100 |
| Ethernet Cable CAT 6 GREEN, 50' | 100105 |
| Ethernet Cable CAT 6 RED, 50' | 100106 |
| Operator's Control Box | 5006-0 |
| Scan (Exposure) Switch | 5007-0 |
| Geometric Phantom | 2803 |
| QA Phantom | 2802 |

Accessories:

The system has no accessories.

System Dimensions:

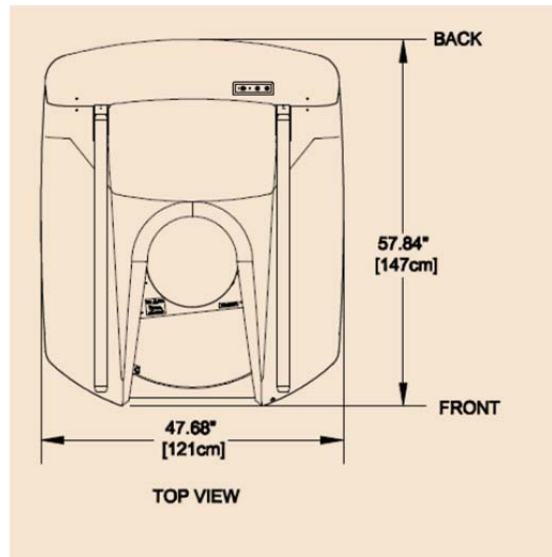
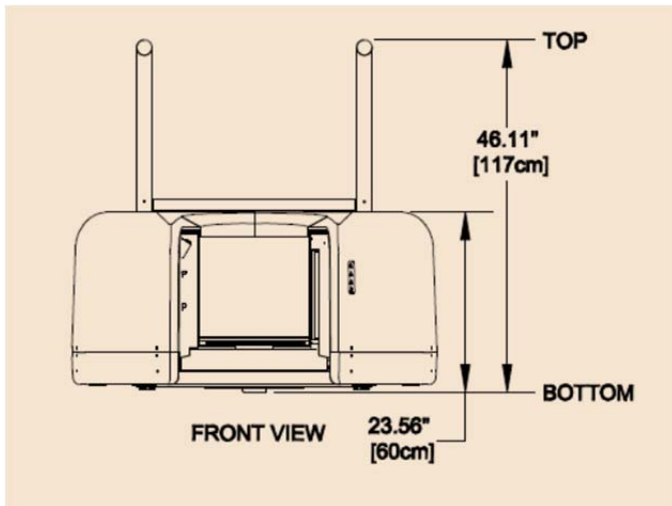

CHAPTER 3: Safety Items

In order to maintain the safety of patients and operators of this device, it is important to operate and maintain the system correctly, following all instructions, warnings, cautions in this manual and labeling on the system itself.

System Safety Devices:

Emergency Stop: In the event of an emergency (any moving component collides with any parts of the equipment or items in the environment, or that could cause physical injury to the Patient), the Operator or Patient should utilize one of the 2 designated Emergency Stop buttons to turn off the power to the X-ray and all moving parts in order for the Patient to be safely removed from the machine. There is an Operator E-stop button on the Operator Control Box and there is a Patient E-Stop button on the machine by the seat. The Emergency Stop (s) when activated will remove ALL power from the machine. If the machine gates are closed, they will have to be opened manually and any obstructions to the patient exit manually removed.

Warning System: The System is equipped with provisions for warning lights and/or audible alarms when X-ray power is energized. An externally powered Warning System can be connected to the cable provided which is capable of 250 volts, 50/60 hertz, and 1 amp. When X-ray power is energized the warning system is also energized.

Interlock System: This System is equipped with provisions for an Interlock Circuit which, when opened, will turn off X-ray power. This is a low voltage circuit, 5 volts DC. To use the Interlock Circuit disconnect the factory installed Shorting Plug. Connect the supplied Interlock Cable to the scanner. Connect door switches (NO/COM terminals) and/or emergency stop switches (NC/COM terminals) in series between the other end of the Interlock Cable wires. Multiple door switches and/or emergency stop switches can be connected as long as the devices are connected in series. The entire circuit must be a closed loop when all of the doors are closed and/or emergency stop switches are in their normally closed state.

Whenever the door switch or switches are opened or emergency stop button(s) pressed the X-ray power will be turned off. X-ray power cannot be turned on when the interlock circuit is open.

Interlock and Warning System Schematic:

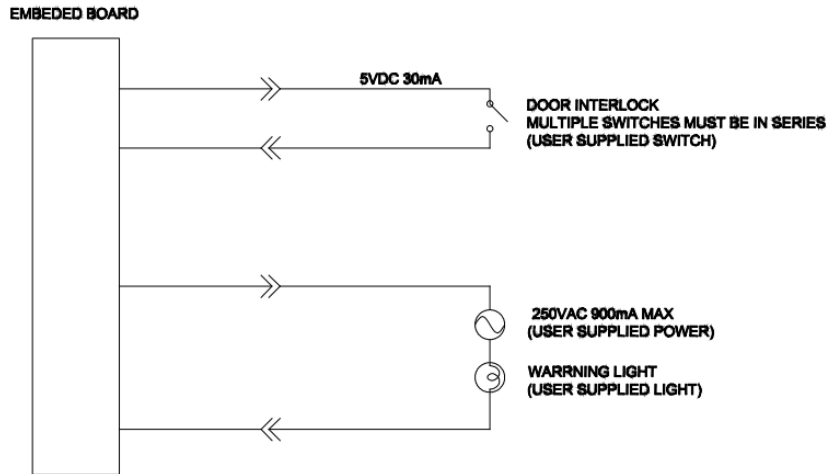

Patient Preparation Recommendations:

We recommend the patient wear FDA approved medical gloves for gripping the hand rails, with sanitation and convenience in mind.

We also recommend the patient not step bare foot on the patient platform. Proper foot protection should be provided.

After each patient scan, clean and disinfect all items which come in contact with the patient.

Cabling Requirements:

System cabling connections must be installed away from walkways and doorways. It is recommended to run cabling along wall perimeters. If there is a chance of mechanical damage due to the cable location, then the use of conduit or other means of protection should be considered.

Emergency Removal of a Patient:

The system has undergone extensive testing of the mechanically, electrically and software performance, but if an unexpected occurrence is observed and/or the software locks up during a scan or an emergency arises where it becomes necessary to interrupt a scan and/or remove a patient from the system before a scan is completed, please follow these steps:

1. Press the EMERGENCY STOP button. This will halt the X-ray as well as the motors to the machine functions and all power to the machine. The message below will display on screen and will terminate the “CB Scanning Device” Acquisition software:



2. Open the Gate doors manually with your hands by using the slots at the top of each door to grasp and slide to an open position.
3. Carefully assist the patient to step out of the scan platform area.
4. Reset the machine: Close the PedCAT Acquisition, “CB Scanning Device” software (if not already). Release the E-stop by turning the knob to the right until it pops up. Then turn the machine power back ON at the Main Circuit Breaker. Re-launch the PedCAT Acquisition “CB Scanning Device” software. Now the system can be operated again as expected.

System Labels:

Operator Control Box: E-Stop, Power ON light, X-ray Ready light, X-ray ON light, Fault light, holster for Scan/Exposure Switch.

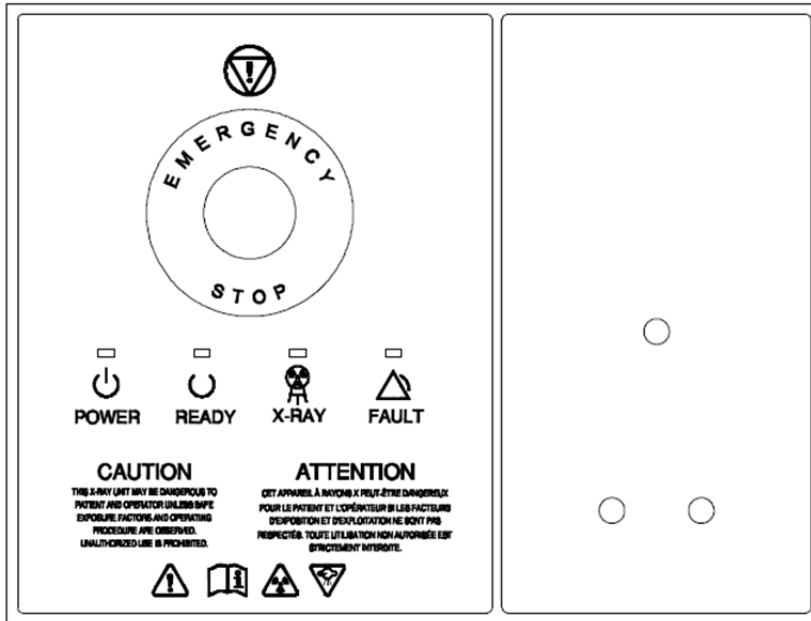

Operator Exposure\Scan Switch (Pushbutton):



Rear Connector Panel:

Voltage Nameplate location

System Label location

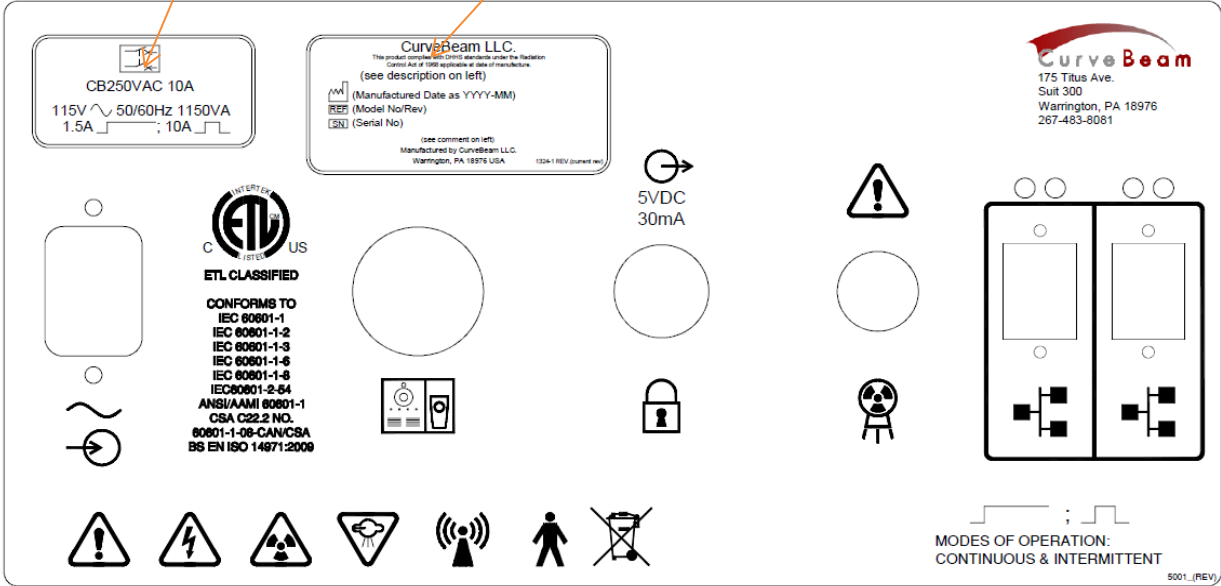

Rear Panel:

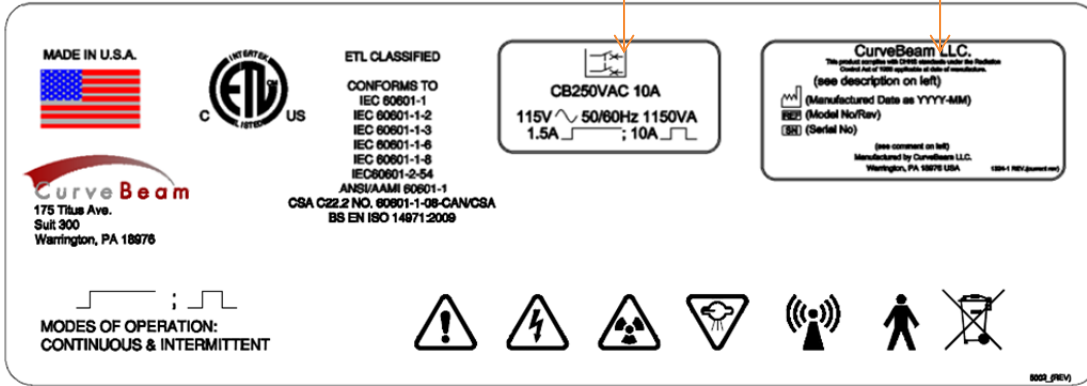

Voltage Nameplate for opening in Rear Connector Panel and Rear Panel:

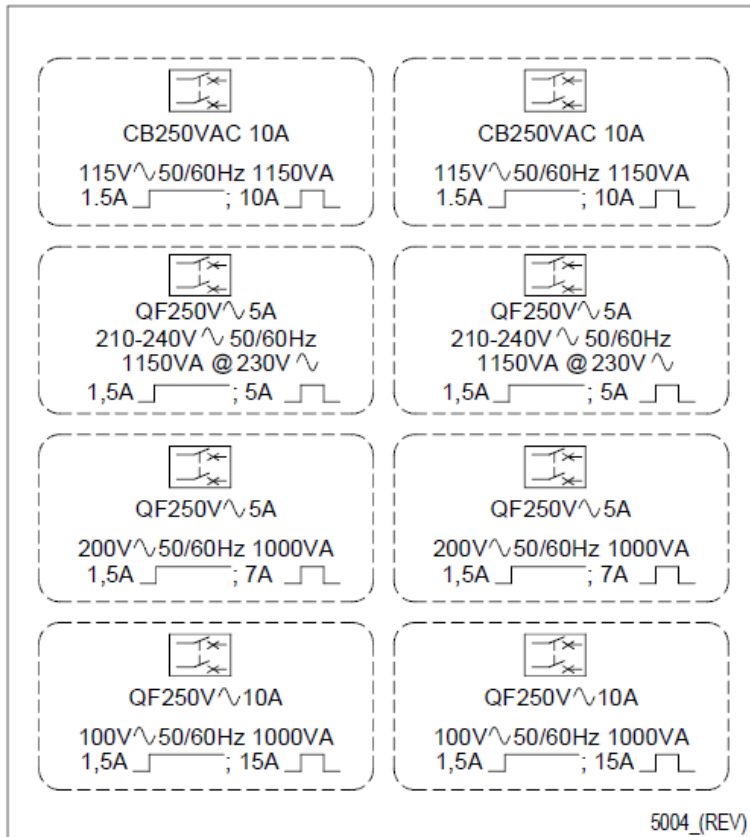

Indicator Panel (on machine):



Patient Platform label:



Patient Seat label:



Handle Bar Label:

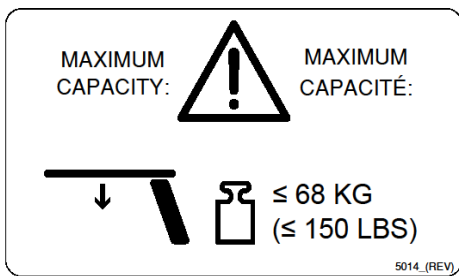

Cleaning Instructions Label:

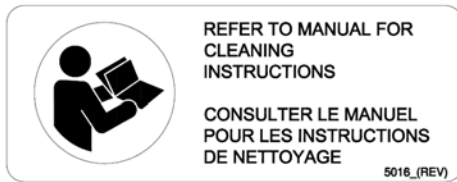

Pinch Point Label:

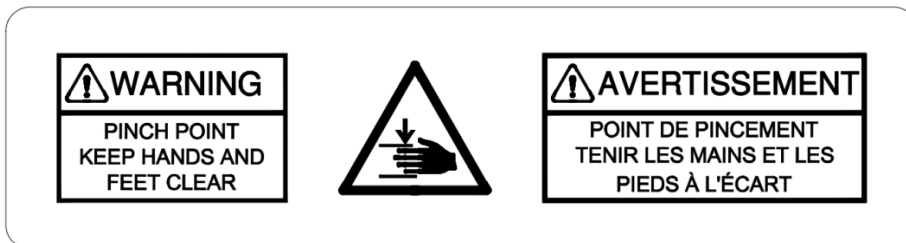

Laser Label:

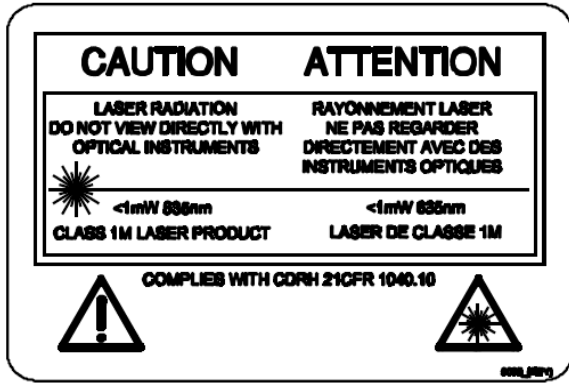

Laser Switch Label:



Circuit Breaker and Fuse Label:

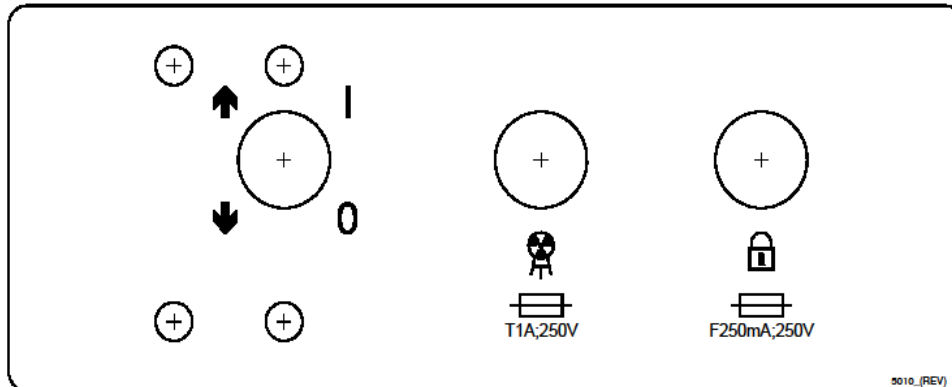

X-ray Protective clothing label (located on the handle bar):

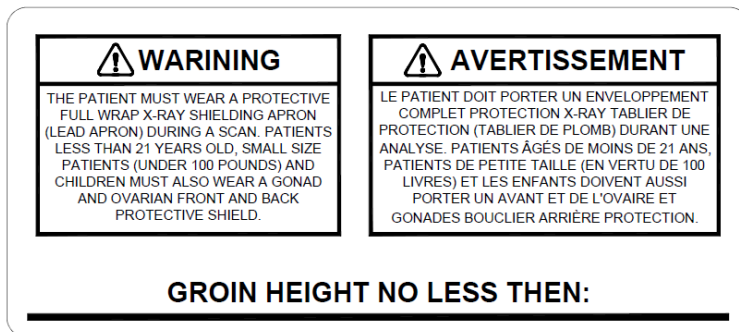

System Label:

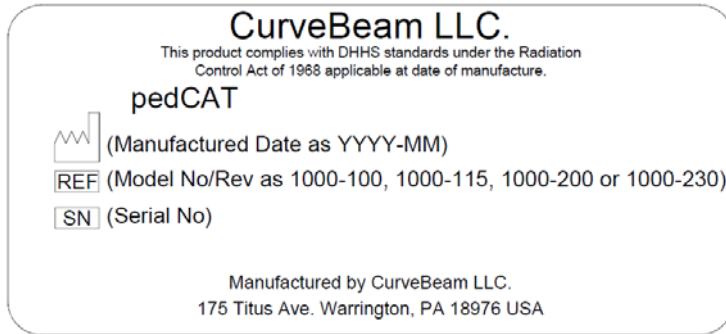

Tube Head Label:

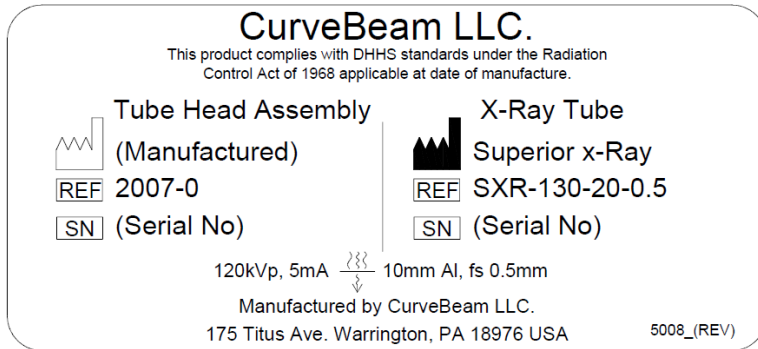

Tubehead Focal Spot Label:









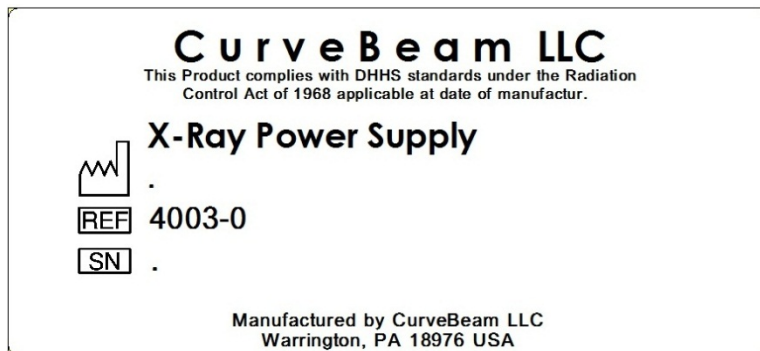

















Beam Limiter Label:



X-Ray Power Supply label:

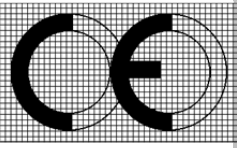

| SYMBOLS: | | | |
|---|--|---|--|
|  General Warning |  Ionizing Radiation |  Electrical Hazard |  AC In |
|  Emergency Stop |  X-Ray Radiation |  Non-Ionizing Radiation |  Network Cable |
|  Power |  Follow Operating Instructions for use. |  Type B (body) applied part complies with IEC 60601-1 |  Control Box |
|  Ready |  Scan |  Recycle |  Pinch Point |
|  X-Ray On |  Laser |  Output for Interlock 5VDC 30mA |  Maximum weight capacity for sitting. |
|  Fault |  Maximum Weight capacity for standing. |  Interlock |  Maximum weight capacity for handle bars. |
|  Fuse T1A250V, T=time delay, 1amp, 250volt fuse F250mA250V, F=fast acting, 250mA, 250volt fuse | I Power/Circuit ON O Power/Circuit OFF | <p>CE Mark</p>  class IIb | |
| | | <p>This product carries the CE Mark. The CE Declaration (CE Conformity) becomes invalid if the product is changed without explicit consent of the manufacturer! This applies to all parts, not only to safety elements.</p> | |

| | |
|--|---|
| European Authorized Representative: | ChiroRay Limited Devonshire House 1 Devonshire Street London W1W 5DR |
|--|---|

System Controls and Indicators:

Operator Control Box:

The Operator Control Box contains the status indicator lights as well as the Emergency Stop button and the Exposure Control Switch. This can sit on a table or be mounted on a wall. It is equipped with a 50 foot cable.

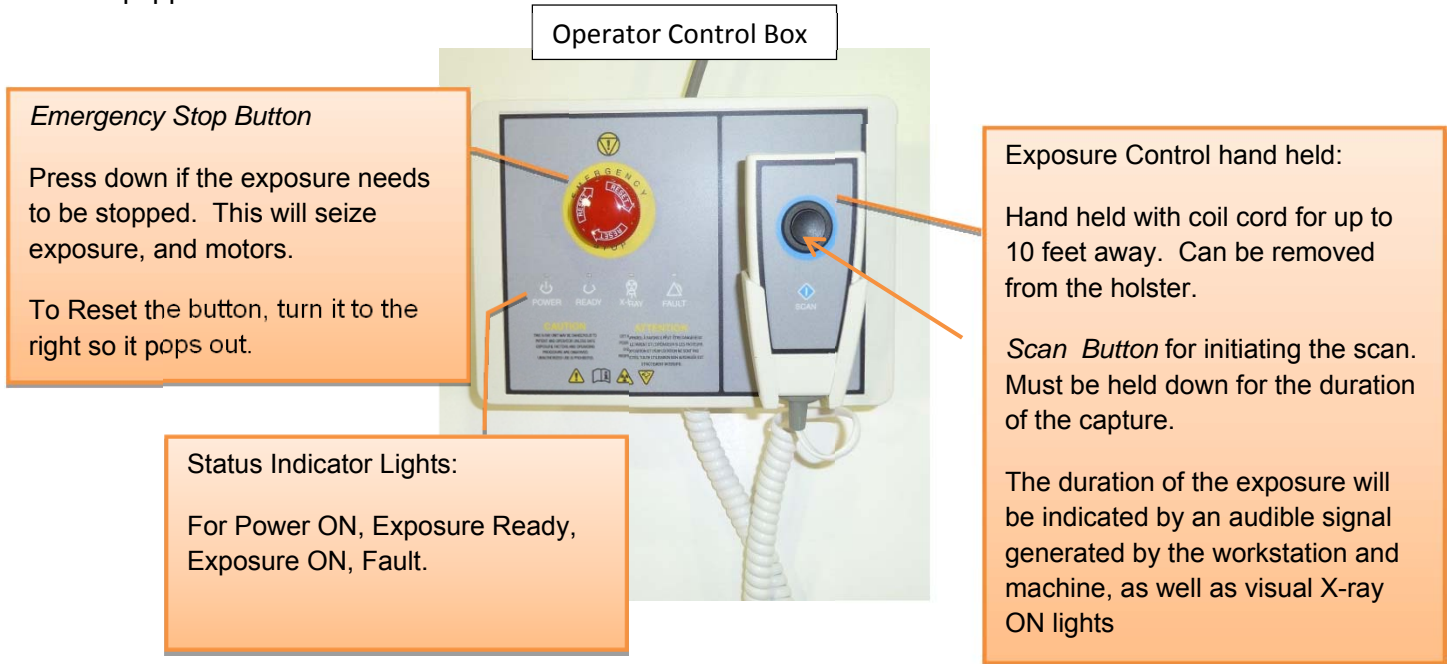

Patient Emergency Stop Button:

This Emergency stop button is intended for the patient to stop exposure during a scan. This will seize exposure and all motors. It is located on the machine itself, by the seat, as shown below. To Reset the button, turn it to the right so it pops out.

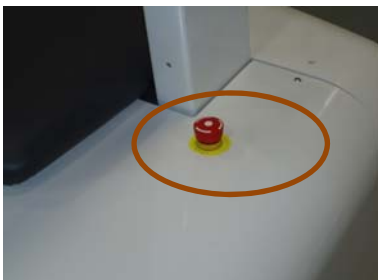

Patient Alignment Laser Lights:



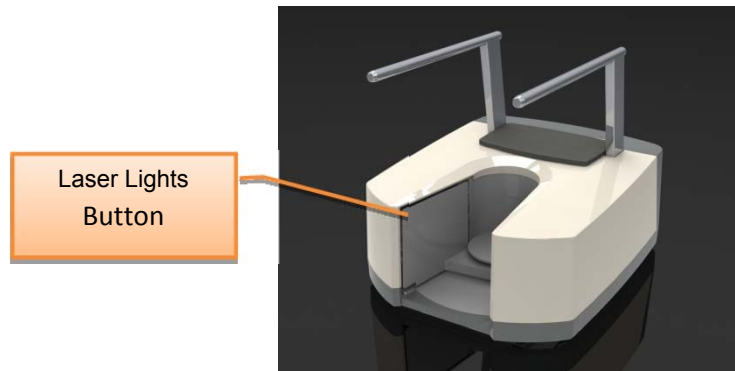

There are 3 patient alignment laser lights on the machine. There is a horizontal and vertical in the center of the beam, and a horizontal at the top of the beam height. The patient alignment laser lights are controlled by a push button on the machine on the left door when open. When the button is pushed and held down, the lights will illuminate.



System Status Indicators

There are 4 indicator lights. These indicator lights are on the Operator's control box and on the machine itself on the upper right cover. There are also similar indicators within the Acquisition software program.

The lights are as follows:

-  **Power ON:** This is solid **Green** when the machine is ON.
-  **Ready:** This is the Exposure Ready light and is **Green** when the machine is in Ready state for exposing. This would indicate that it is time to press the exposure button.
-  **X-Ray ON:** This is an **Amber** color when the system is exposing, emitting X-ray.
-  **Fault:** This would be **Red** in color if there was a failure in the system.

Status Indicator panel on Operator Control Box: *under Emergency Stop button.*



Status Indicator panel on machine: *front right and left cover*



CHAPTER 4: Calibration and Quality Assurance (QA) Procedures

Calibration Procedures:

There are seven Calibration/Alignment Procedures. These steps should all be performed in sequence at installation of the system and then again on an annual maintenance schedule. Calibration Procedures should be performed only by factory trained technicians.

To complete all of the calibrations, allow at least 2 hours.

The Calibrations to be performed are:

1. Find Center of Rotation
2. A/B/Center Distance Measurement
3. Collimator Setup
4. Panel Rotation
5. Panel Gain Calibration
6. Panel Air Normalization Calibration
7. Geometric Calibration

The tools required for Calibration:

Centering Tool

Geometric Phantom with alignment set screw

Ensure that all safety precautions are taken for the location in which these procedures are being performed. If the office is equipped with the Door Interlock Option, ensure that the appropriate measures are taken to be able to perform a scan and fire the x-ray. If needed, there is always the option to release the Scan button or to use the E-Stop to stop the x-ray in the middle of a calibration. If the E-Stop is depressed, it will cause the power switch on the back of the scanner to shut off. Reset the E-Stop by rotating it, then restart the scanner by flipping on the power switch at the back of the scanner. Then restart the calibration at the beginning of the calibration that was interrupted. If the scan button is released prematurely during a calibration, rerun the current calibration.

Log-in required for Calibration:

Start on the Acquisition Station terminal. Close any open applications. For the Calibration Procedures, the “cbadmin” account must be logged in. To determine the

current user that is logged in, left mouse click on the Windows Start icon  in the lower left corner of the screen. If the user is anything other than “cbadmin”, in the upper right corner, then the user will need to be changed.

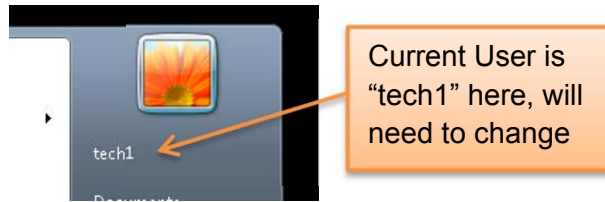

If the user is already “cbadmin” skip the remaining portion of this setup and proceed to the “Find Center of Rotation” section below. If the user currently logged in is not “cbadmin”, then in the same column as the user name appears, at the bottom locate the “Log off” button, select the arrow to the right of it and select “Disconnect” to log off the current user.

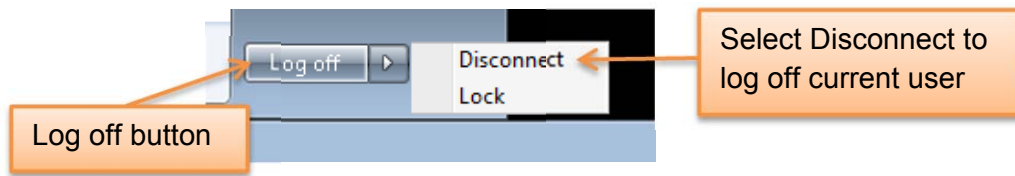

Double click on the Acquisition Login icon on the desktop and log in as “cbadmin”. If the “cbadmin” user isn’t visible and expecting a password, select the “Use another account” and enter “cbadmin” as the user name. For the password, please contact CurveBeam Technical Support.

1. Find Center of Rotation

Remove all objects from the Field of View in the scanner.

Remove the Patient Platform from the scanner.



Place the Centering Tool into the center of the metal disc from where the patient platform was removed. There are 2 holes on the metal disc that will fit the two metal prongs at the bottom of the centering tool. The Centering Tool will fit in one of two ways, either way is acceptable for this procedure.

Holes in metal disc in the patient platform area
(with patient platform removed):



Center tool properly placed:

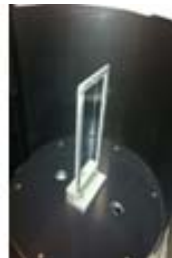

Double click on the “AlignPanel – Shortcut” on the desktop to start the Panel Calibrations.

The following will open:

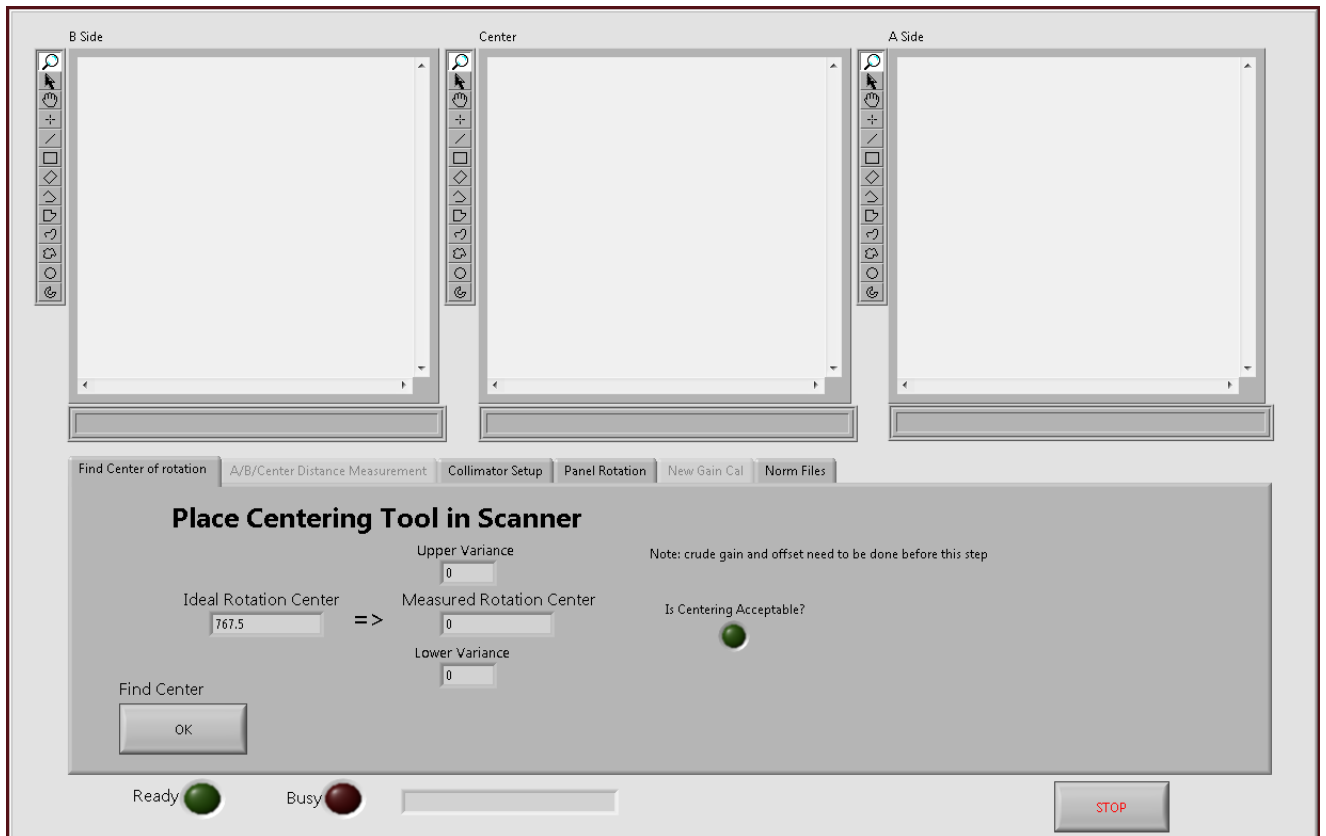

Place the Centering Tool in the scanner.

Click on the Find Center OK button in the lower left corner.

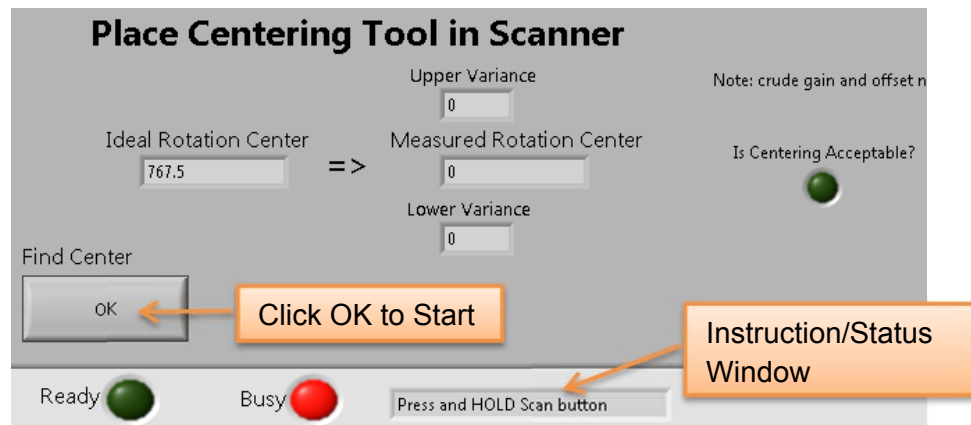

When prompted, Press and Hold the Scan button to fire the x-ray.

 **WARNING** The X-ray device may be dangerous to the Patient and Operator if you do not observe and follow operating instructions. Do not operate this system unless you have received training to perform a procedure

Once the x-ray has completed, release the scan button. The image on the screen will look similar to the below image:

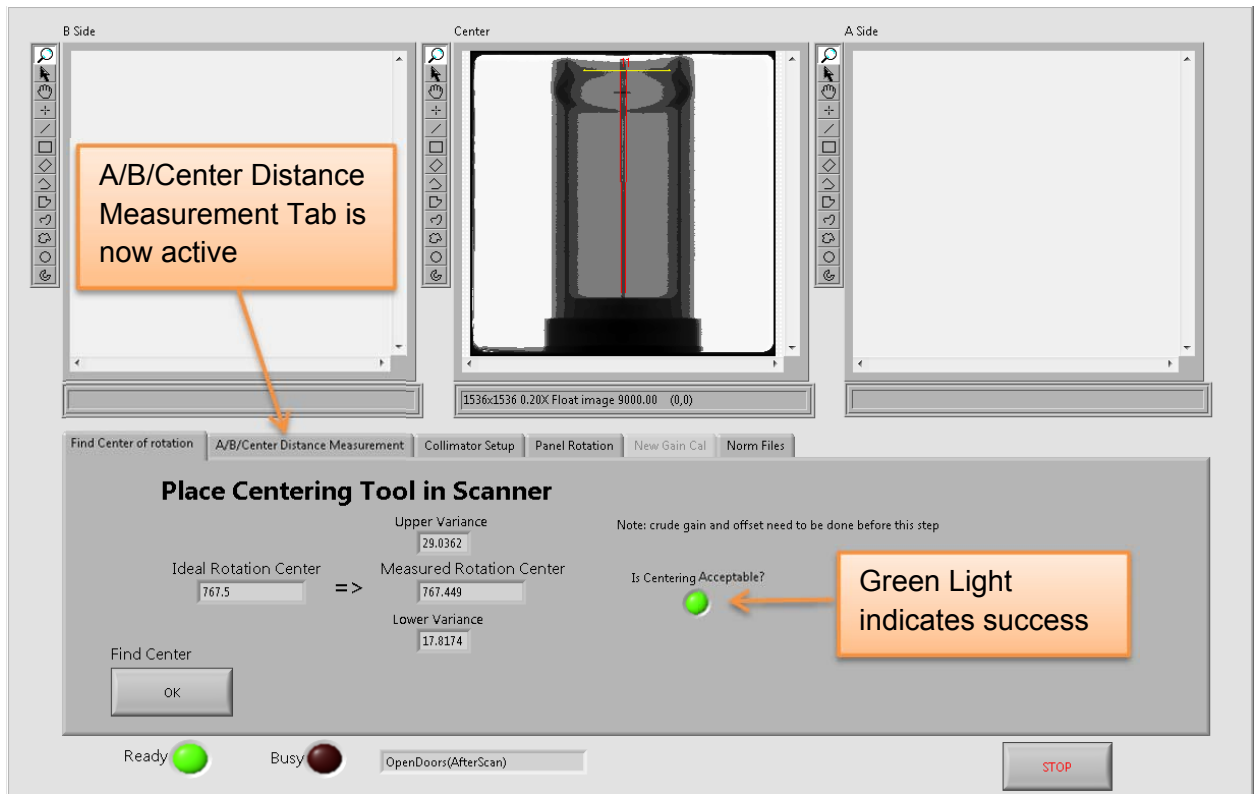

At this stage, observe the light under “Is Centering Acceptable?” to see if the light is green. If the light is green, the activities in this tab are completed. Notice that the A/B/Center Distance Measurement tab is now active.

2. A/B/Center Distance Measurement

Click on the A/B/Center Distance Measurement tab.

Note: without a successful “Find Center of Rotation” calibration, this tab will not be active or able to be selected.

The following will appear:

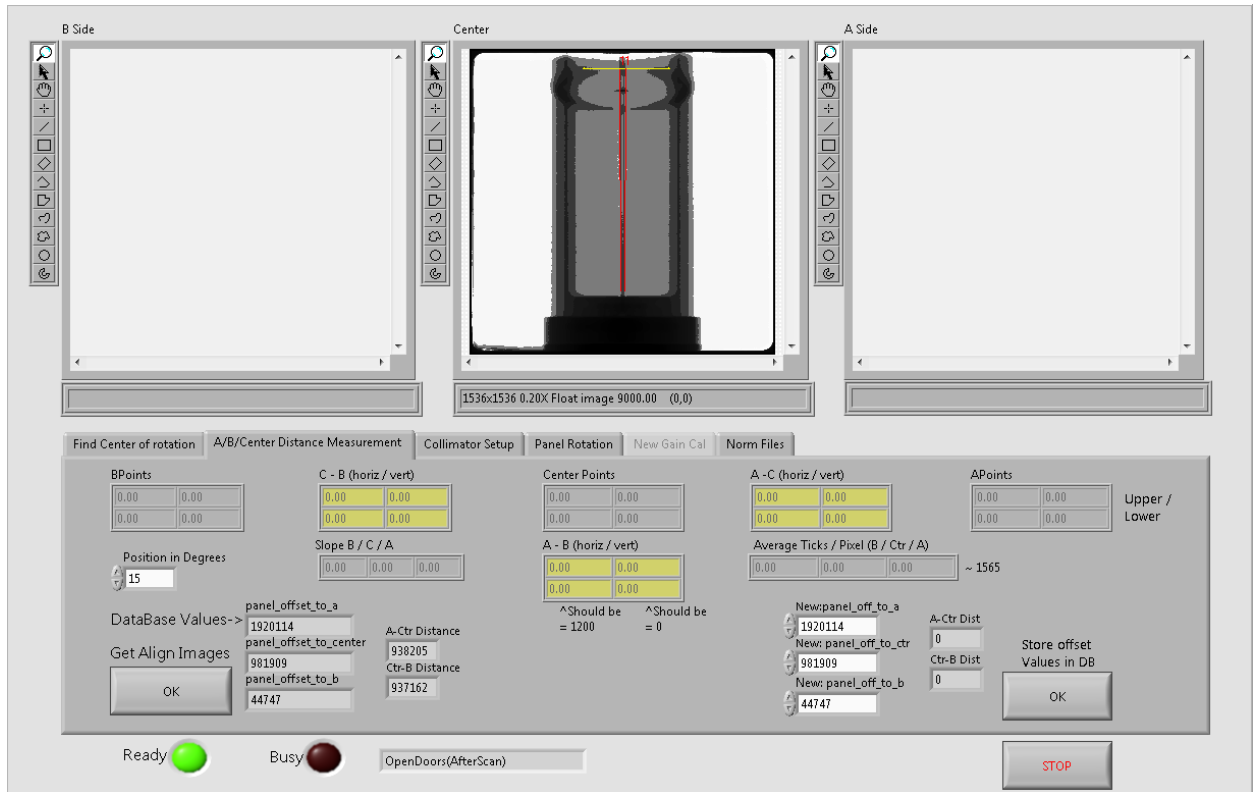

Ensure that the Center Tool is still set up in the scanner.

Click on the Get Align Images OK button in the lower left corner.

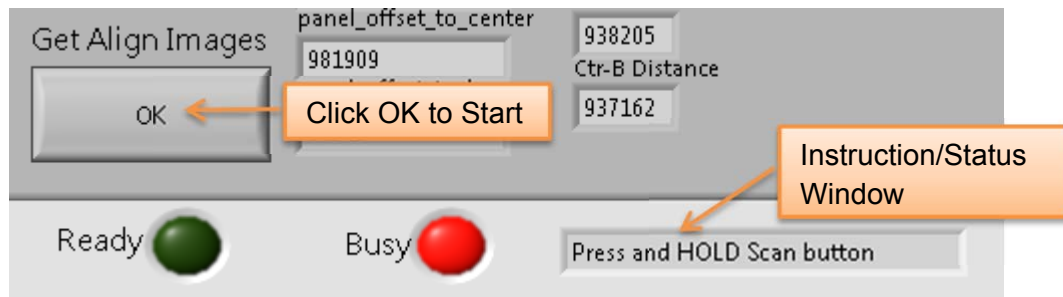

When prompted, Press and Hold the Scan button to fire the x-ray.

⚠ WARNING The X-ray device may be dangerous to the Patient and Operator if you do not observe and follow operating instructions. Do not operate this system unless you have received training to perform a procedure

Once the x-ray has completed, release the scan button. The image on the screen will look similar to the below image:

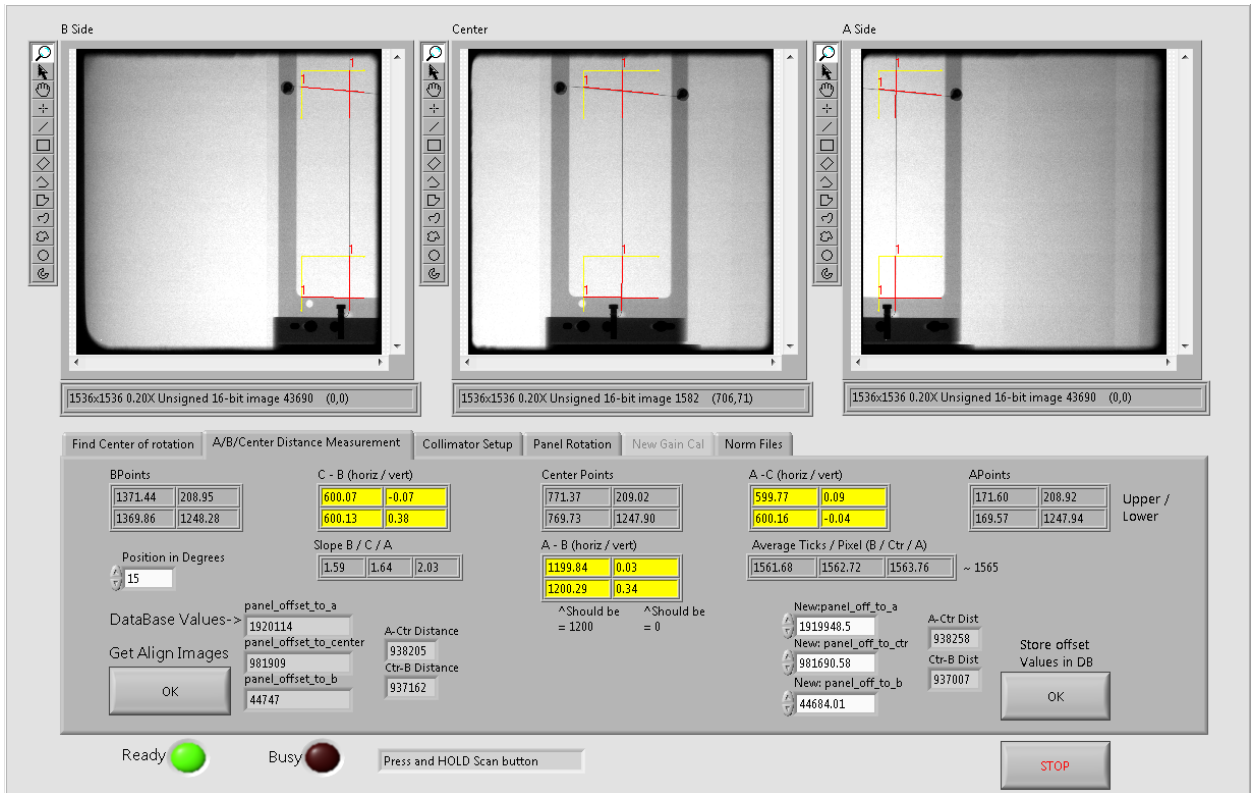

Observe the values in the yellow boxes.

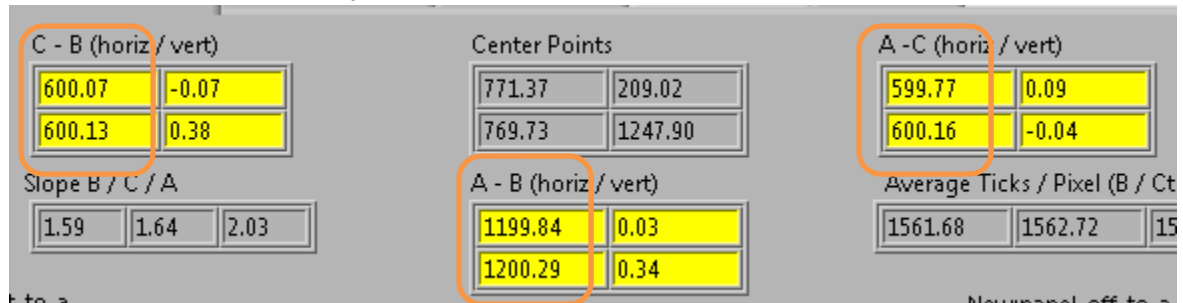

The left column values for both “C-B (horiz / vert)” and “A – C (horiz / vert)” values should be 600 +/- 0.5 pixels. The “A – B (horiz / vert)” values in the left column

should be 1200 +/- 0.5 pixels. If these values are not within the specified ranges, click on the Store offset Values in DB OK button in the lower right corner. This will save the present values and force a repeat of the Find Center of Rotation Calibration from before. Repeat the Find Center of Rotation Calibration, then this calibration (A/B/Center Distance Measurement), until these values are within range.

After verifying the yellow values are within the allowable range, zoom in on both the top and bottom places on each of the three screen shots to verify the image where the red lines intersect. For all three images, the location of the red lines, relative to the wire scanned should be about the same, as below:

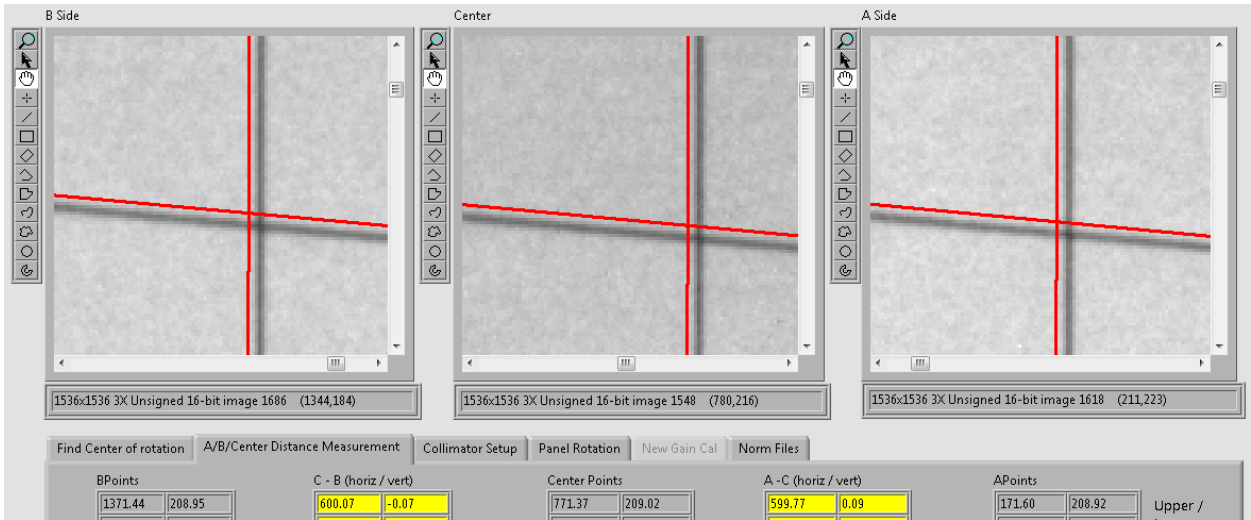

Notice how the red lines intersect at about the same position on all three images. Repeat this for the lower intersection of the lines as well. If the red lines intersection is not similar to the wire and to each other, select the Store offset Values in DB OK button in the lower right corner. This will save the present values and force a repeat of the Find Center of Rotation Calibration from before. Repeat the Find Center of Rotation Calibration, then this calibration until these values are within range.

If the yellow values are good and the intersections all look about even, then this calibration is complete. Do not click on the Store offset Values in DB button unless there is a problem with either of the values or locations of red lines.

3. Collimator Setup

Remove the Centering Tool from the scanner.

Click on the Collimator Setup Tab. The following should appear:

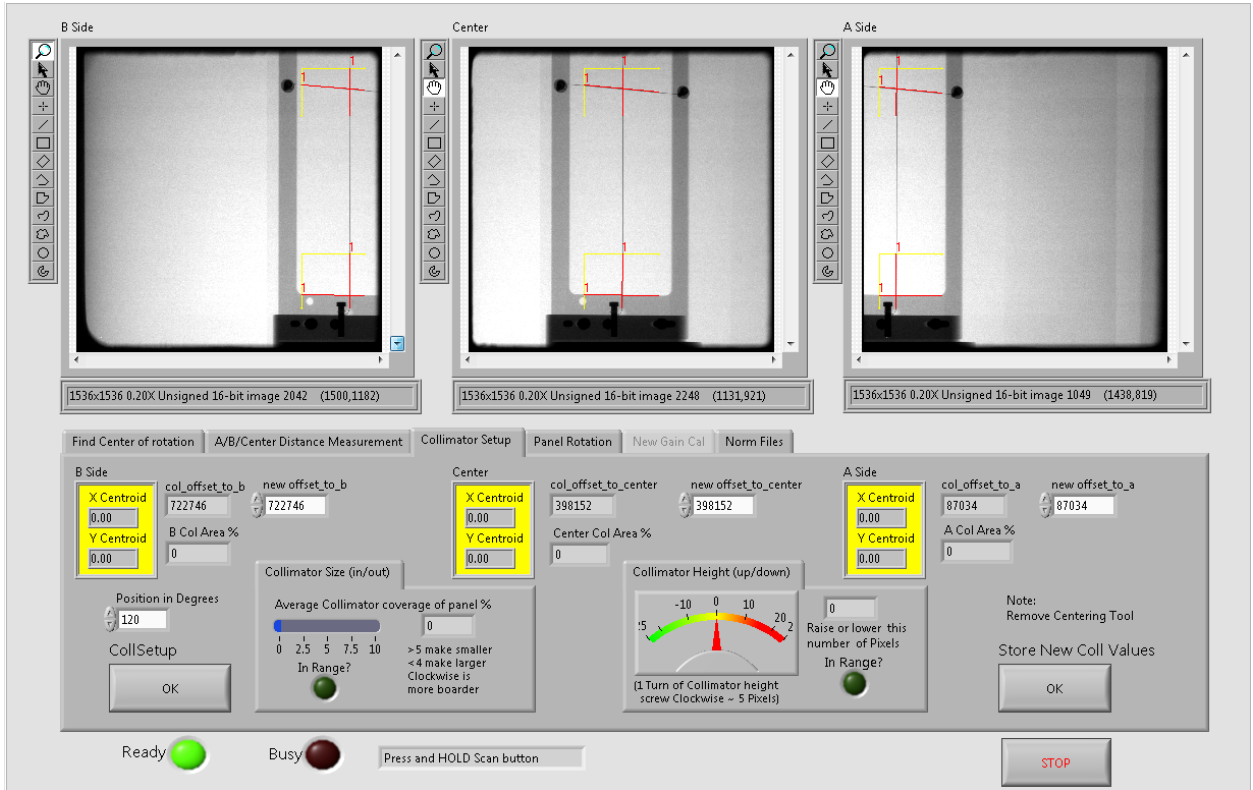

Click on the CollSetup OK button in the lower left corner.

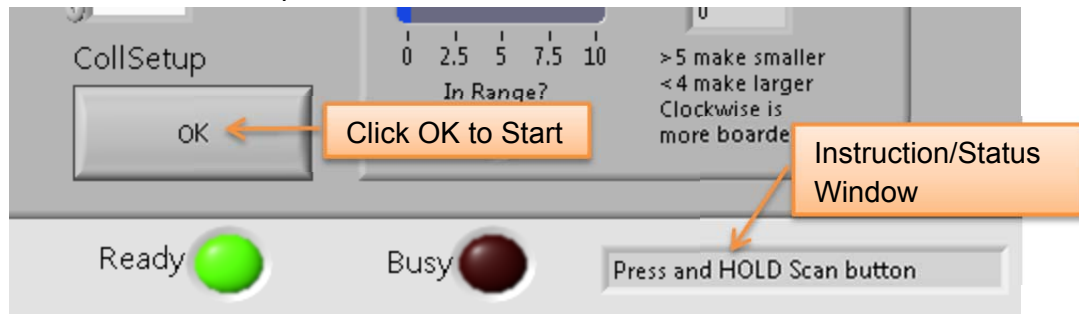

When prompted, Press and Hold the Scan button to fire the x-ray. The x-ray will fire 3 single shots of x-ray.

WARNING The X-ray device may be dangerous to the Patient and Operator if you do not observe and follow operating instructions. Do not operate this system unless you have received training to perform a procedure

Once the x-ray has completed, all 3 static images (x-ray fired 3 times) below have been updated, release the scan button. The image on the screen will look similar to the below image:

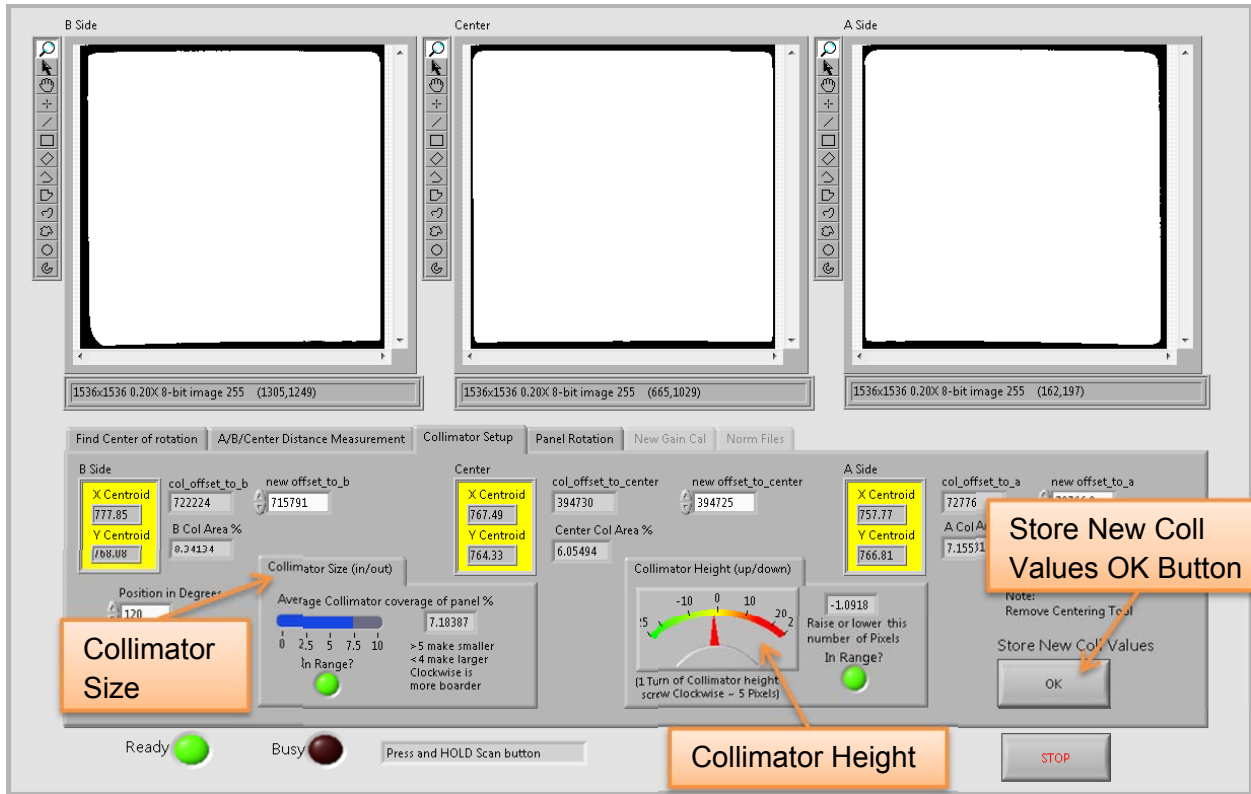

The 3 panel locations should look similar to the above images. The goal is to try and get as much white as possible, while still leaving some black edges. For the B side image, the black line on the right will generally be more narrow than the left side, this is desired. The opposite is true for the A side image, the left side should have less black edge than the right side, again, this is desired. The Center image, if adjusted much further will end up with no more edge on the left and right side, therefore, the image displayed is desired as well.

In addition to the images, a few values need to be considered as well. The first adjustment required is for the Collimator Height. The acceptable Collimator Height (up/down) range is 0 +/- 5 pixels. Instructions on screen are given for adjustments. Turning the lower screw clockwise will cause it to move up. The second adjustment required is for the Collimator Size. The acceptable Collimator Size (in/out) range is between 4-8%. Instructions on screen are given for adjustments. Turning the higher

screw clockwise will provide more border around the images by moving away from the tube head and closer to the panel.

If adjustments are needed, it may be necessary to manually rotate the gantry to get to the Collimator Adjustment Screws. Below is an image of the collimator adjustment screws, depicting which screw to use for each adjustment needed to the collimator:

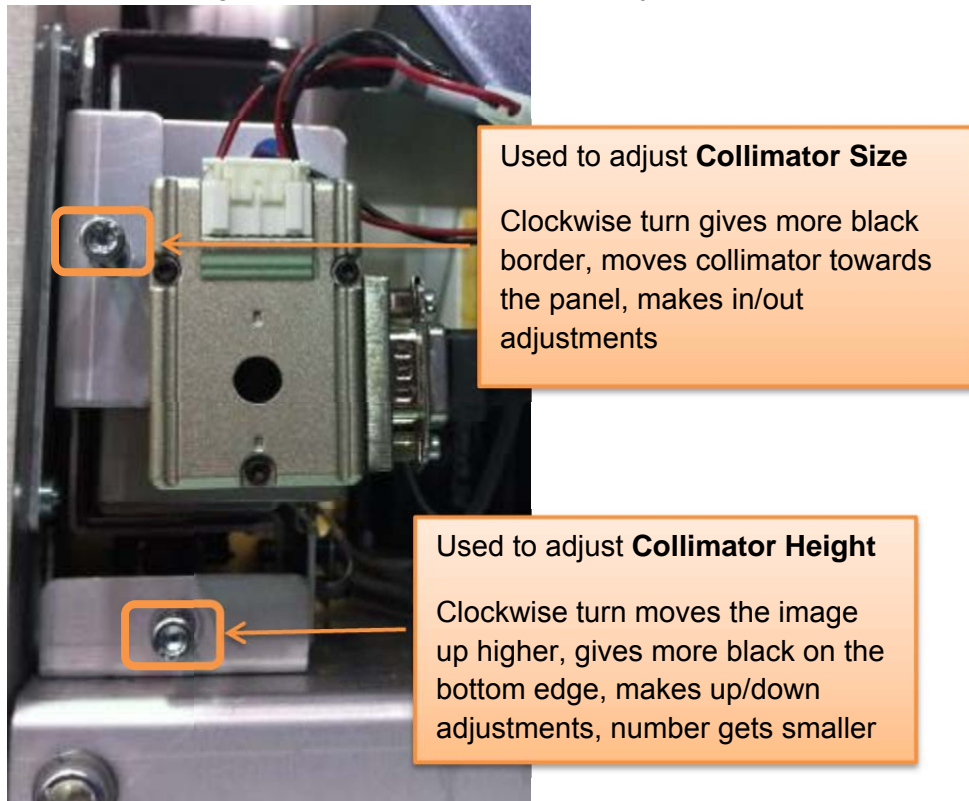

If any adjustments are needed, the present values must be stored first before the calibration is continued. Select Store New Coll Values OK button in the lower right corner to store the current values. Then restart this calibration by clicking CollSetup OK again. Revisit the images and values as mentioned above. Repeat these steps until the images appear as shown above and the values are as presented above.

Once the images appear to maximize the white image and both the Collimator Height and Collimator Size numeric values are within the ranges specified, select Store New Coll Values OK in the lower right corner to store the current values for this calibration.

4. Panel Rotation

Place the Geometric Phantom in the Scanner. If needed rotate gantry counter clockwise for easy access to the center of the scanner.

Click on the Panel Rotation Tab. The following should appear:

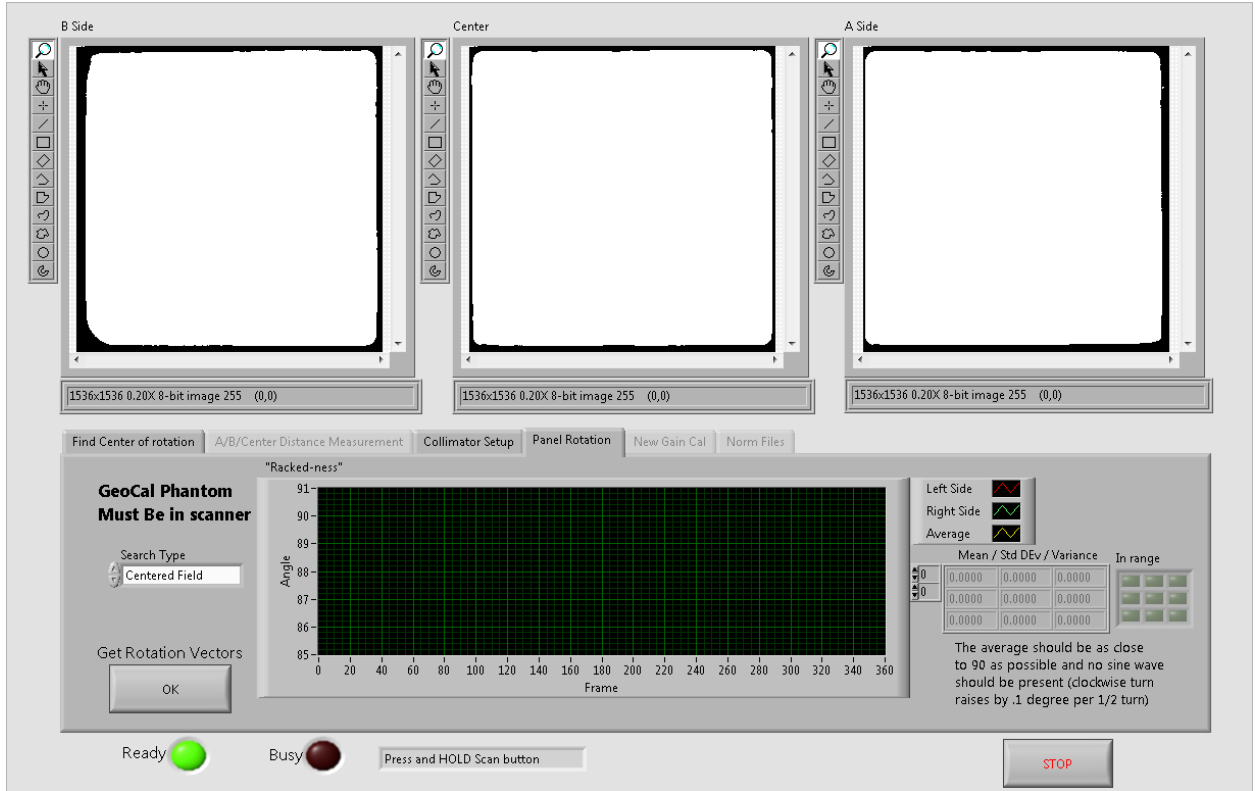

For each Search Type listed (Centered Field and then Wide Field), click on the Get Rotation Vectors OK button in the lower left corner.

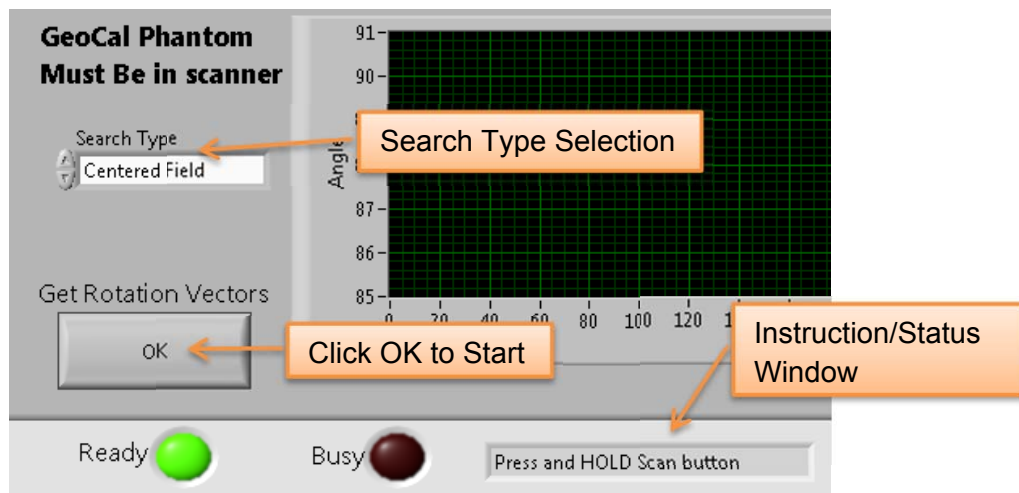

When prompted, Press and Hold the Scan button to fire the x-ray.

 **WARNING** The X-ray device may be dangerous to the Patient and Operator if you do not observe and follow operating instructions. Do not operate this system unless you have received training to perform a procedure

Once the x-ray has completed, release the scan button. The image on the screen will look similar to the below image:

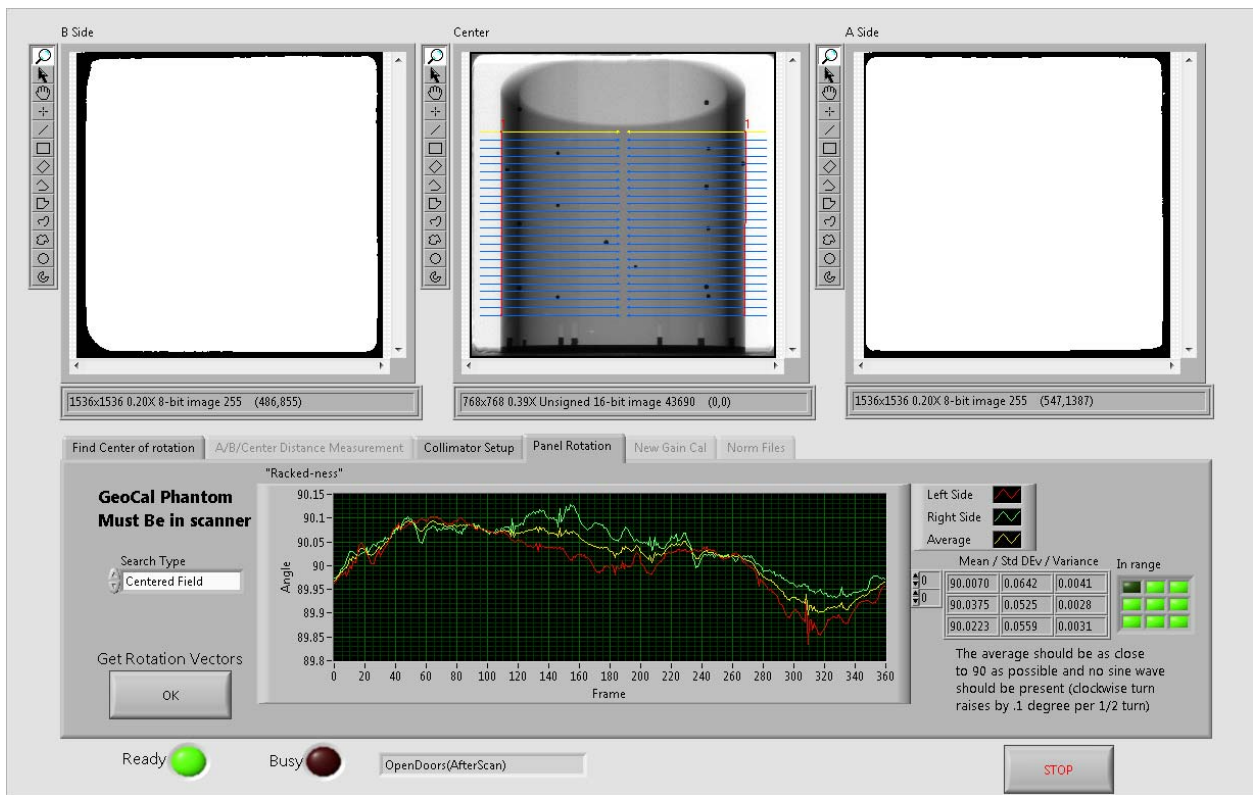

Find Center of rotation | A/B/Center Distance Measurement | Collimator Setup | Panel Rotation | New Gain Cal | Norm Files

GeoCal Phantom Must Be in scanner

Search Type: Centered Field

Get Rotation Vectors: OK

Ready ● Busy ● OpenDoors(AfterScan)

STOP

| Mean / Std Dev / Variance | In range |
|---------------------------|--------------------------|
| 90.0070 0.0642 0.0041 | <input type="checkbox"/> |
| 90.0375 0.0525 0.0028 | <input type="checkbox"/> |
| 90.0223 0.0559 0.0031 | <input type="checkbox"/> |

Once the scan is completed, the value for the Mean value (first column) in the third row should be 90 +/- 0.1. The Green lights on the right side of the screen should be green for the third row, mean value (first entry) as seen below:

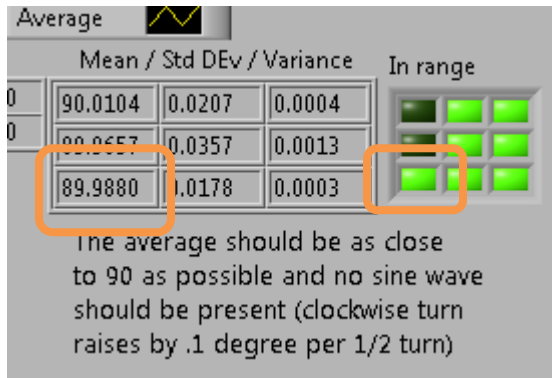

If adjustments are needed, adjust the screws on the mounting plate for the panel as shown below:

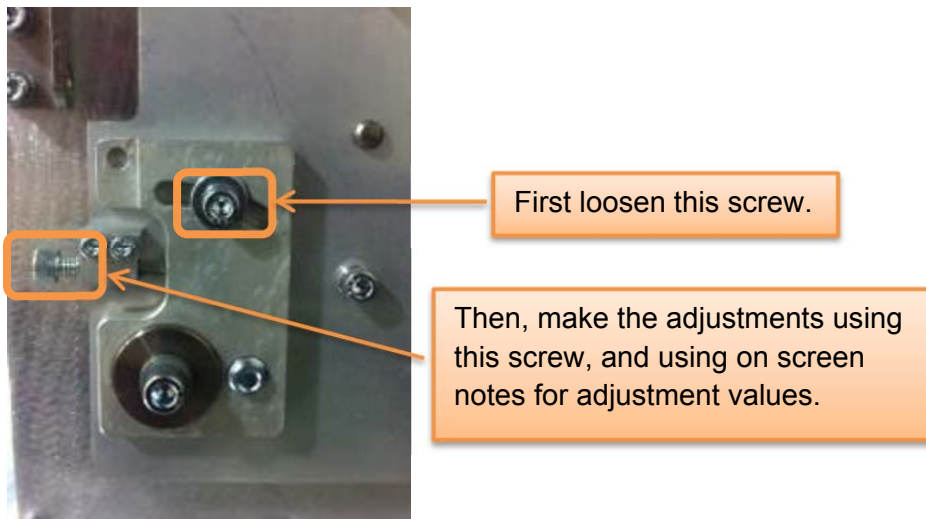

Repeat this calibration for all types listed under the Search Type pulldown.

Once all Search Types have been completed, close the AlignPanel Calibrations by clicking on the STOP button in the lower right corner. The Align Panel program will close.

5. Panel Gain Calibration:

Remove all objects from the Field of View in the scanner.

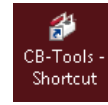

Open the CB-Tools by using the shortcut on the desktop:

The following main menu for CB-Tools will be displayed:

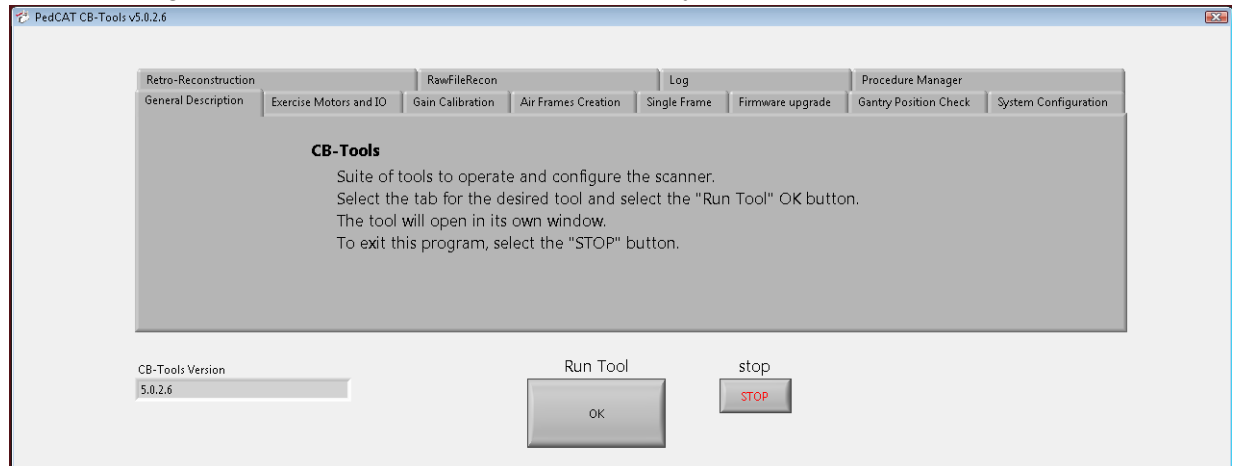

Select the "Gain Calibration" tab in CB-Tools. Then select "OK" under Run Tool.

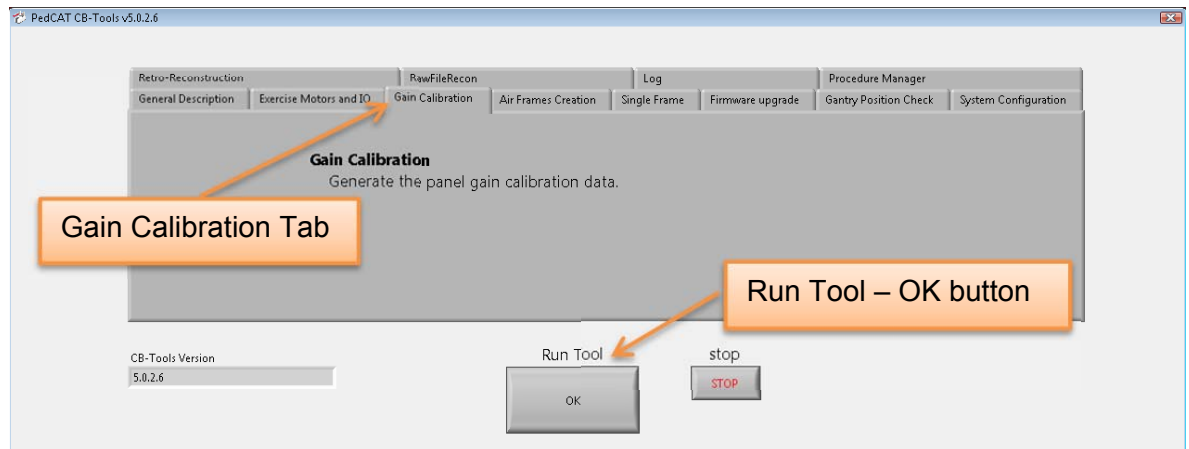

When the program is launched the Panel Gain Calibration window will open, with CB-Tools still visible in the background. Follow the User Instructions for this calibration. When the User Instructions state to "Select the 'Start' button to continue." select the "Start Cal" button as shown in the image below.

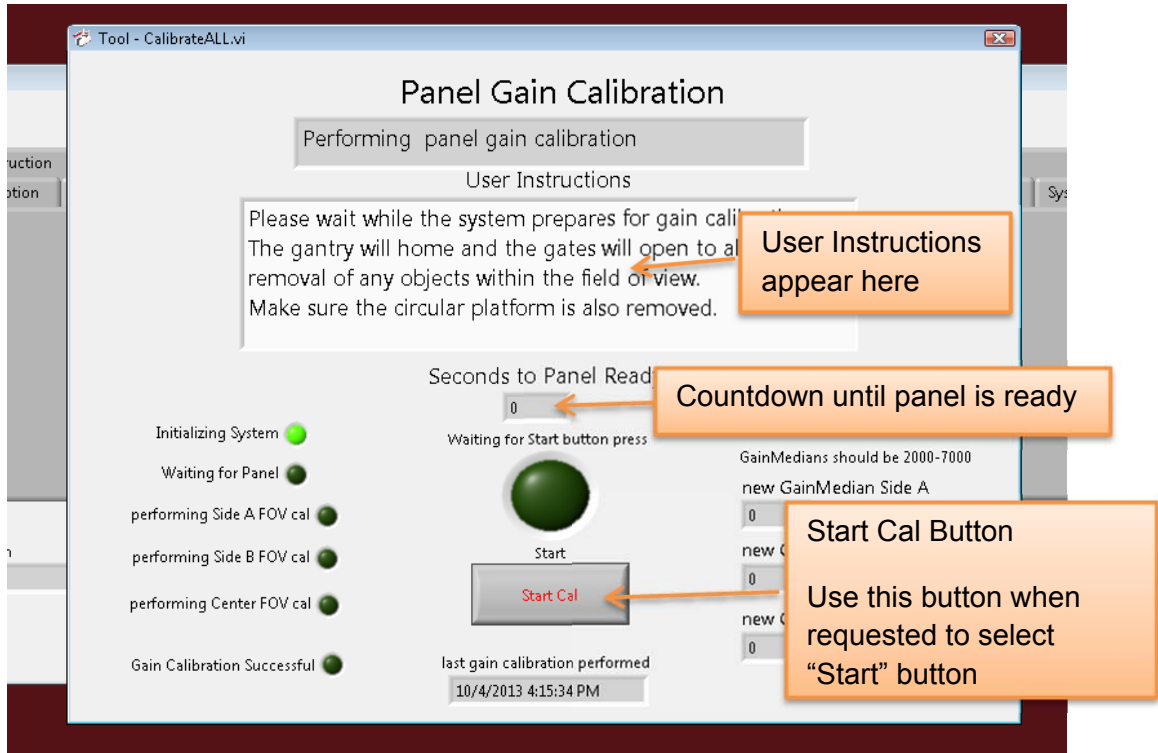

When going through the instructions, the program will require x-ray to be fired. There will be a prompt to hold the Scan button, at which point x-ray will be fired. It may take a moment, but there will be the sound of x-ray being fired and afterwards, there will be another User Instruction to release the Scan button.

 **WARNING** The X-ray device may be dangerous to the Patient and Operator if you do not observe and follow operating instructions. Do not operate this system unless you have received training to perform a procedure

After each time that x-ray is fired, the panel will need to discharge. There is a countdown box that will display the seconds until the panel is ready and then the User Instructions will be updated as to what to do next. X-ray will be fired THREE times throughout this calibration.

 **WARNING** The X-ray device may be dangerous to the Patient and Operator if you do not observe and follow operating instructions. Do not operate this system unless you have received training to perform a procedure

When the calibration is completed, the Gain Calibration will close and CB-Tools will be displayed on the screen. Keep CB-Tools open.

6. Panel Air Normalization Calibration (Air Frames Creation):

WAIT 5 MINUTES before starting this Calibration. The panel needs time to discharge and this procedure will need to be performed after waiting a full 5 minutes from the end of the Gain Calibration just performed.

There are two portions to this calibration, the first will be performed using CB-Tools, the second will be performed from the Recon Manager VM.

Remove all objects from the Field of View in the scanner.

Select the “Air Frames Creation” tab in CB-Tools. Then select “OK” under Run Tool.

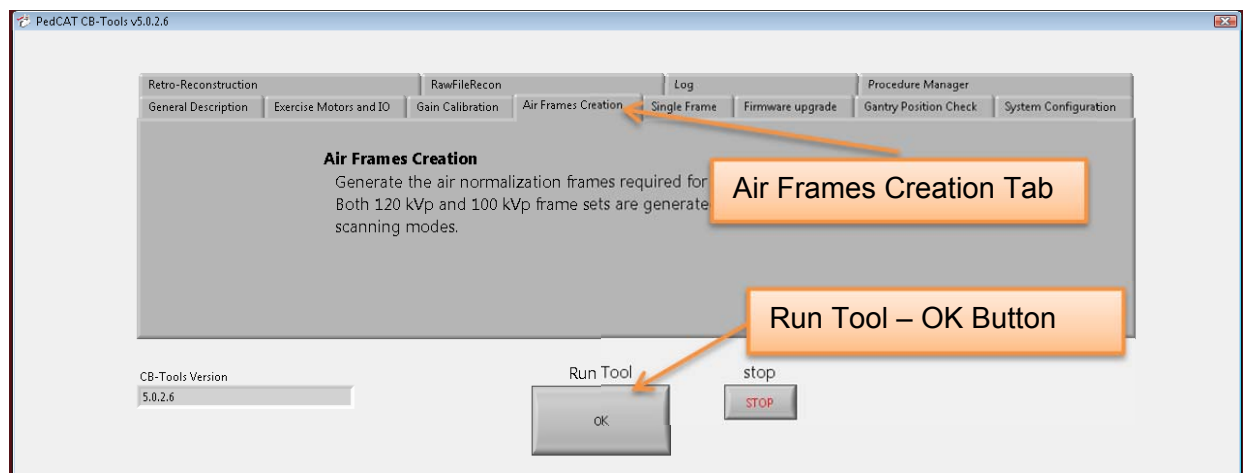

Follow the User Instructions for this calibration. When going through the instructions, the program will require x-ray to be fired. There will be a prompt to hold the Scan button, at which point x-ray will be fired. It may take a moment, but there will be the sound of x-ray being fired and afterwards, there will be another User Instruction to release the Scan button. X-ray will be fired SIX times total, three for 120kVp and three for 100kVp.

 **WARNING** The X-ray device may be dangerous to the Patient and Operator if you do not observe and follow operating instructions. Do not operate this system unless you have received training to perform a procedure

There will be a long delay between some of the calibration steps. There is a countdown box that will display the seconds until the panel is ready and then the User Instructions will be updated as to what to do next.

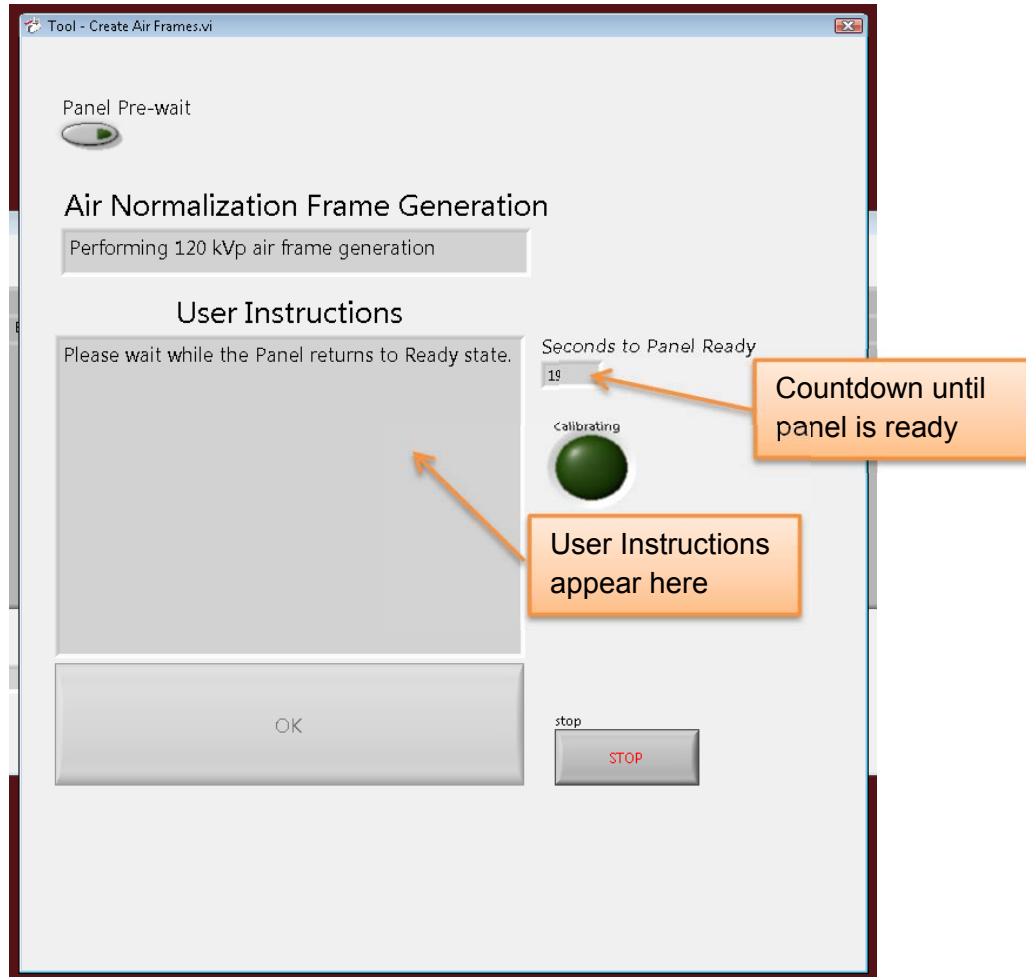

The system will perform the 120kVp calibrations and will require x-ray to be fired THREE times. The scanner will reposition itself and then perform the 100kVp calibrations and again fire x-ray THREE times. There will be a total of SIX times in which x-ray will be fired during this Panel Air Normalization Calibration.

 **WARNING** The X-ray device may be dangerous to the Patient and Operator if you do not observe and follow operating instructions. Do not operate this system unless you have received training to perform a procedure

When the calibration is completed, the Air Frames Creation Calibration window will close and CB-Tools will be displayed on the screen.

Close the CB-Tools program by clicking on the STOP button.

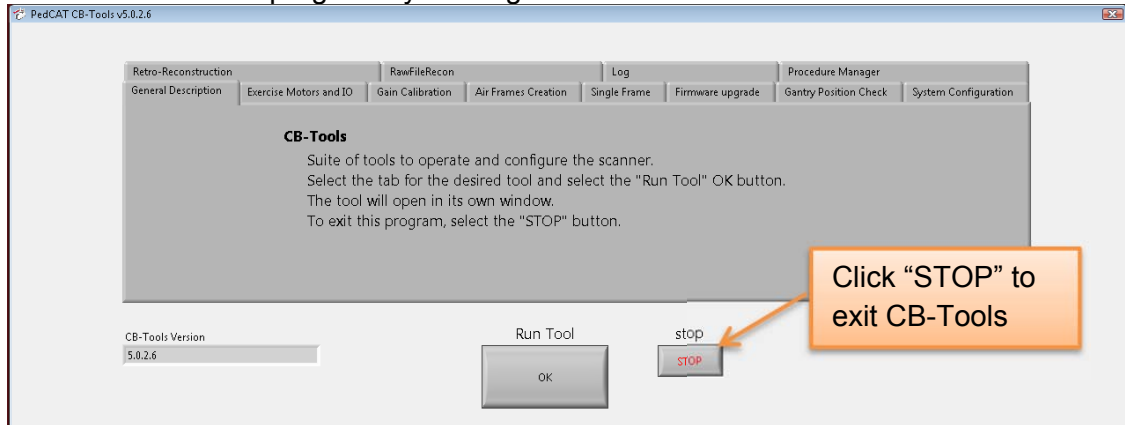

Ensure that all programs are closed, both Acquisition and CB-Tools. Then exit out of the ACQ VM.

What follows now is the second portion of the Panel Air Normalization Calibration.

Login to the Recon VM by clicking on Start then Remote Desktop. Obtain Login and Password from CurveBeam Technical Support.

Once logged into the Recon VM, close the Recon Manager program.

This part of the calibration will be processing four input folders. The procedure below will be done four times, but with some slightly different parameters for the four different input folders.



Start the CBGenNormfile application from the shortcut on the desktop or from the file on the desktop, depending on server setup.

Once open, the Input Folder will need to be set to: Y:\Airframes\768x768x100
To do this, select “Browse” on the Input Folder line. Then navigate to the “Y” drive and the Airframes folder. Click on the 768x768x100 folder. Then click on OK.

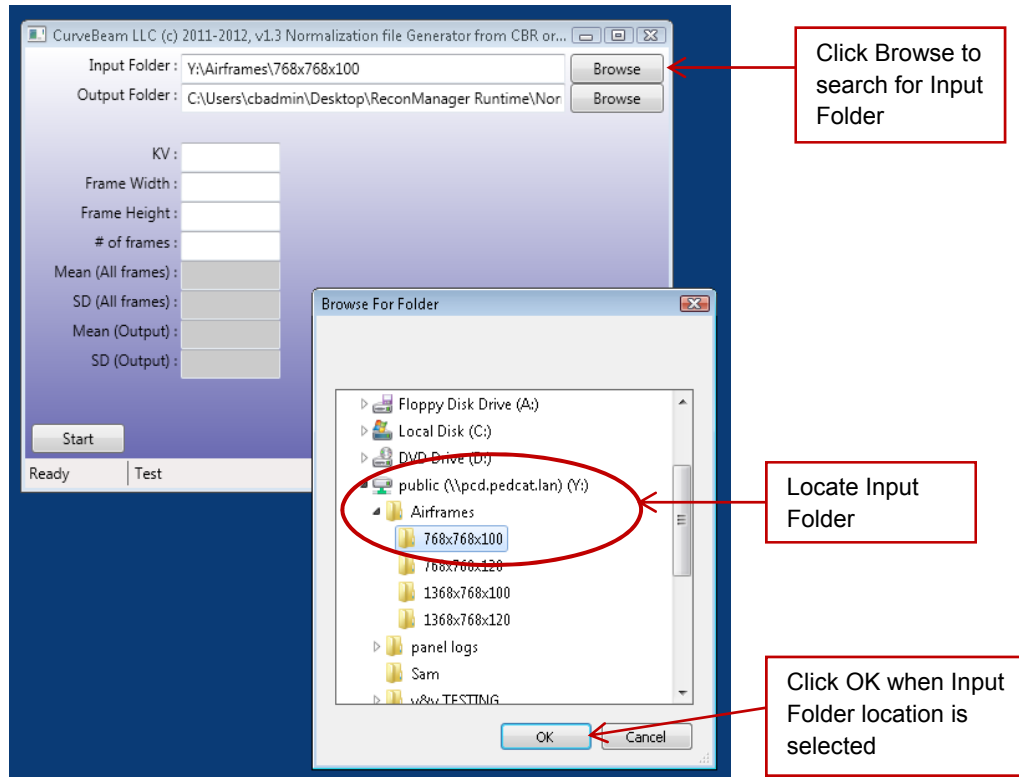

The output folder does not get changed and should remain at:
C:\Users\cbadmin\Desktop\ReconManager Runtime\Normalization
Please note, if this is the first time the server is running this procedure, this Output folder will need to be set. But once set, the folder should remain as specified above for any future times through this process.

Enter the following values:

KV: 100

Frame Width: 768

Frame Height: 768

of frames: 128

The window should now look as follows for the FIRST input folder:

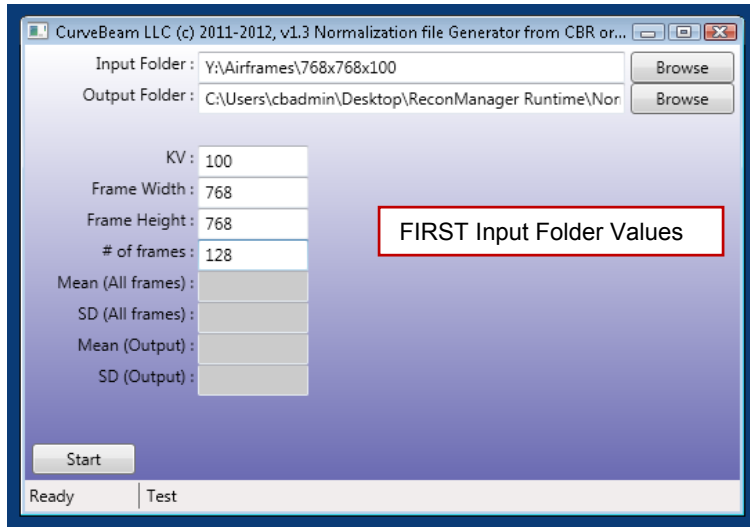

Click Start.

The gray boxes will start to populate and then “Ready” in the lower left corner will change from “Ready” to “Loading data” then to “Analyzing” and then back to “Ready”. Once all of the gray boxes are filled in and “Ready” is displayed again in the lower left hand corner of the box, this input file is completed.

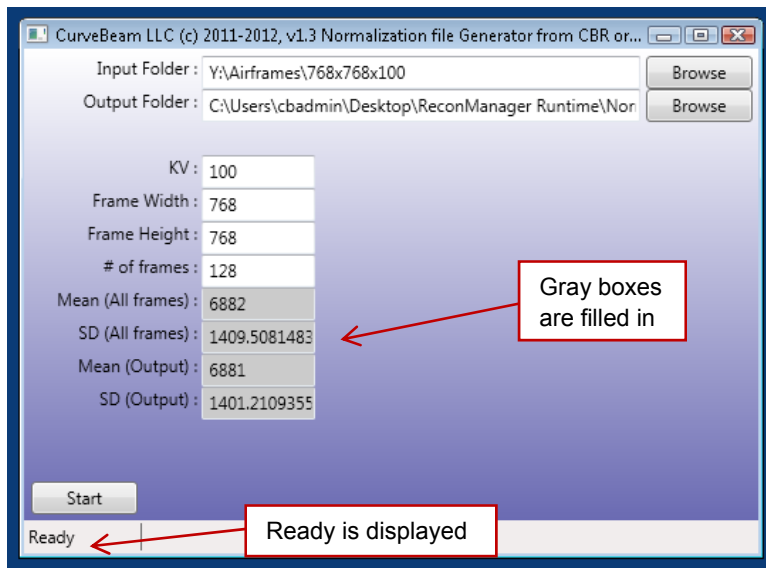

This process will need to be completed THREE additional times for three other input folders and some different input values.

After the gray boxes are all filled in, and “Ready” is displayed in the lower left corner, begin processing the second folder.

For the SECOND input folder, make the adjustments shown below:
Change the Input Folder to: Y:\Airframes\768x768x120

Change KV to: 120

Frame Width: 768 (remains unchanged)

Frame Height: 768 (remains unchanged)

of frames: 128 (remains unchanged)

The image below shows what the program will look like as a result of the changes for the SECOND input folder (above), just verify the white fields are a match as the gray ones are calculated as part of the calibration:

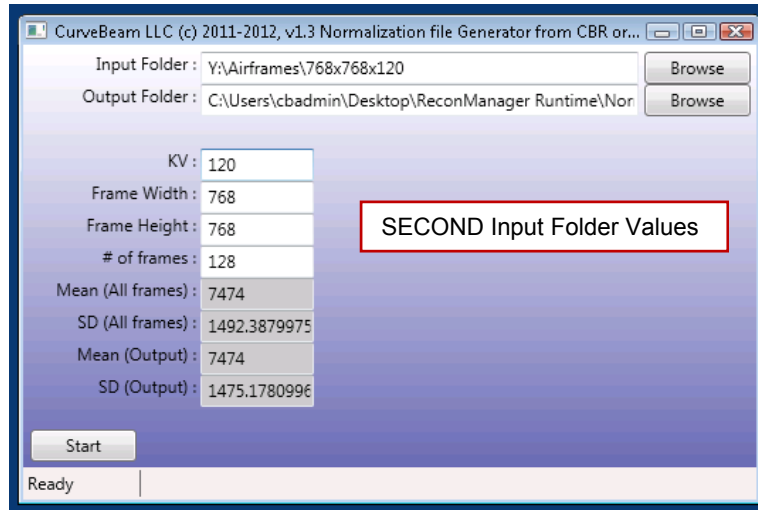

Click Start.

The values in the gray boxes will be recalculated and again the "Ready" will change to "Loading data" then to "Analyzing" and then back to "Ready". Once all of the gray boxes are filled in again and "Ready" is displayed again in the lower left hand corner of the box, this input file is completed.

For the THIRD input folder, make the adjustments shown below:

Change the Input Folder to: Y:\Airframes\1368x768x100

Change KV to: 100

Change Frame Width to: 1368

Frame Height: 768 (remains unchanged)

of frames: 128 (remains unchanged)

The image below shows what the program will look like as a result of the changes for the THIRD input folder (above), just verify the white fields are a match as the gray ones are calculated as part of the calibration:

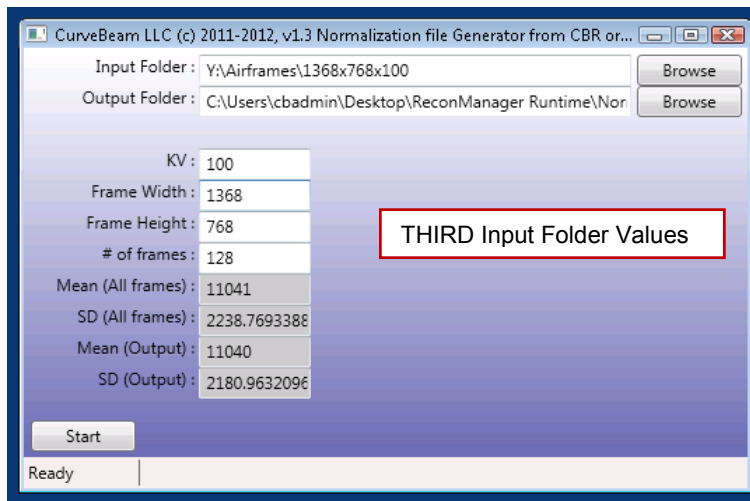

Click Start.

The values in the gray boxes will be recalculated and again the “Ready” will change to “Loading data” then to “Analyzing” and then back to “Ready”. Once all of the gray boxes are filled in again and “Ready” is displayed again in the lower left hand corner of the box, this input file is completed.

For the FOURTH input folder, make the adjustments shown below:

Change the Input Folder to: Y:\Airframes\1368x768x120

Change KV to: 120

Frame Width: 1368 (remains unchanged)

Frame Height: 768 (remains unchanged)

of frames: 128 (remains unchanged)

The image below shows what the program will look like as a result of the changes for the FOURTH input folder (above), just verify the white fields are a match as the gray ones are calculated as part of the calibration:

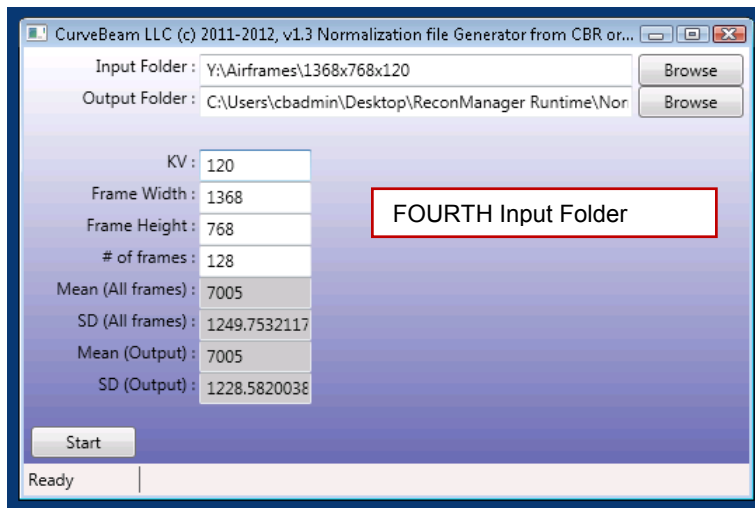

Click Start.

The values in the gray boxes will be recalculated and again the “Ready” will change to “Loading data” then to “Analyzing” and then back to “Ready”. Once all of the gray boxes are filled in again and “Ready” is displayed again in the lower left hand corner of the box, this input file is completed.

Close the CBGenNormFile application by clicking on the red “X” in the upper right corner.

Start the Recon Manager Program.

The second, and final, portion of the Panel Air Normalization Calibration is now complete.

7. Geometric Calibration:

Locate the Geometric Phantom and the alignment set screw. With the platform still removed from the unit, insert the set screw in the most center hole on the metal platform base where the patient would be standing. Turn the set screw two full rotations to insert it.

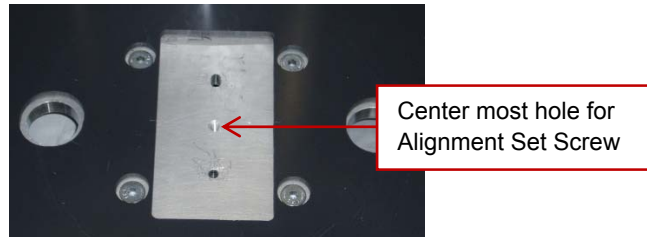

After the set screw is inserted, place the Geometric Phantom on the platform. The set screw will need to come up through the hole in the center metal plate at the bottom of the Geometric Phantom.

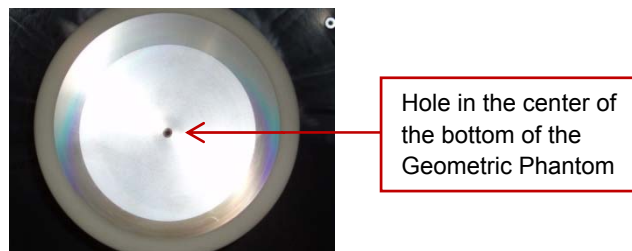

Placing the hole at the center of the base of the Geometric Phantom on top of the set screw in the base of the platform positions the phantom in the correct location. There will be a slight amount of movement with the phantom on the screw, this is perfectly acceptable. The phantom should look similar to the image below:



The full Geometric Calibration, from this point forward, will need to be performed twice. First for a Medium Field scan, then for a Large Field scan. The few differences will be pointed out, but for the majority of the instructions, they will not vary based on the scan field of view. Differences between the two runs of these instructions will be presented with bold text.

From the Acquisition terminal a scan will need to be taken of the Geometric Phantom. For this scan, both the PatientID and PatientName will need to be "geocal". All lowercase for the word "geocal". **The protocol that needs to be selected for the FIRST scan is: "Medium Field (120kVp)" and for the SECOND scan it is "Large Field (120kVp)".** Acquire the scan of the Geometric Phantom.



Advice: Refer to the "Acquiring a Scan" section of the manual for Acquiring the scan.



WARNING The X-ray device may be dangerous to the Patient and Operator if you do not observe and follow operating instructions. Do not operate this system unless you have received training to perform a procedure

Allow the scan to complete. On the Quality tab, view the raw frames. Scroll through the frames and observe the BB's to see if any appear to jump or move sporadically.

Close the Acquisition Software.

Login to the Recon VM. Obtain Login and Password from CurveBeam Technical Support.

Once logged into the Recon VM, close the Recon Manager program.

On the desktop, open the current version of IsoCal folder, named "IsoCalVXXXXRevY" where XXXX is the version number and Y is the Revision, such as "IsoCalV1000Rev2". Double click on "CstIsoCal.exe" to start the IsoCal program. When first opened a windows explorer like box will open requesting a location for the Geometry.xml. Navigate in that window to the Desktop, then to the IsoCal folder (current revision) and select "geometry.xml". The following will now be displayed on the screen:

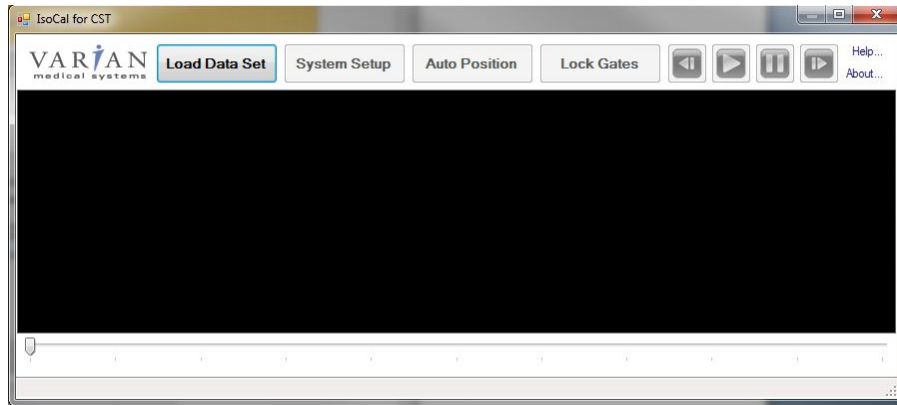

Click the “Load Data Set” button and browse to the Desktop, then “Recon Manager Runtime” folder. From there, select the “GeoCalRawDicomFiles” folder. In this folder, there are all scans that were taken using the “geocal” Patient ID and Name. Select the one with the most recent (or today’s) date, double click on select Open on this file. The screen will then appear similar to the one below:

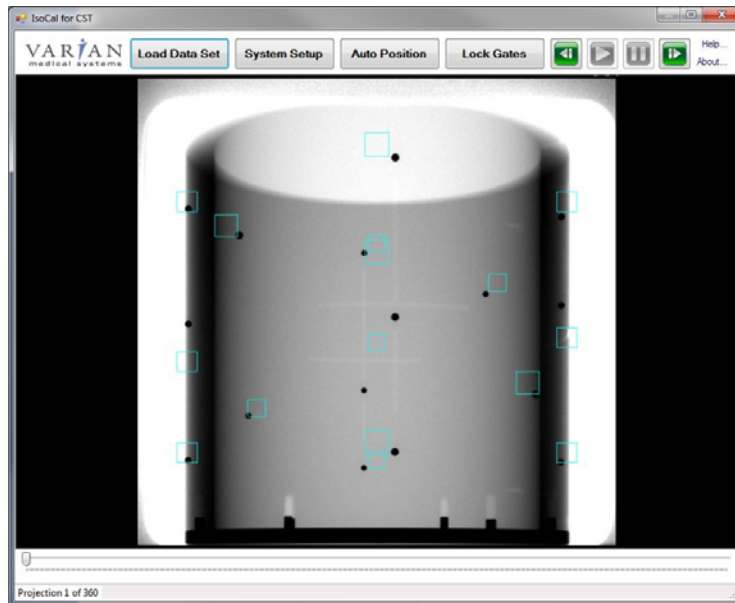

Click the “System Setup” button.

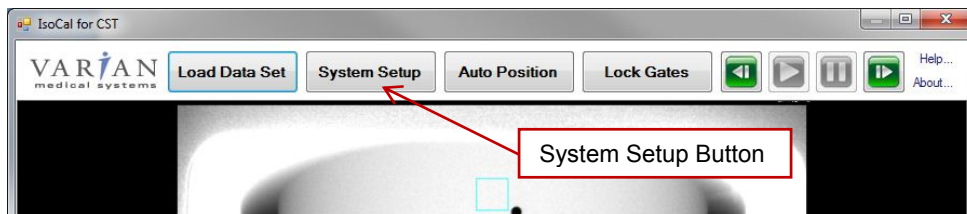

Under the “Acquisition Data” heading on the left, ensure that the Flipped Horizontal box IS checked and the Flipped Vertical box is NOT checked as shown below (the numerical values do not matter):

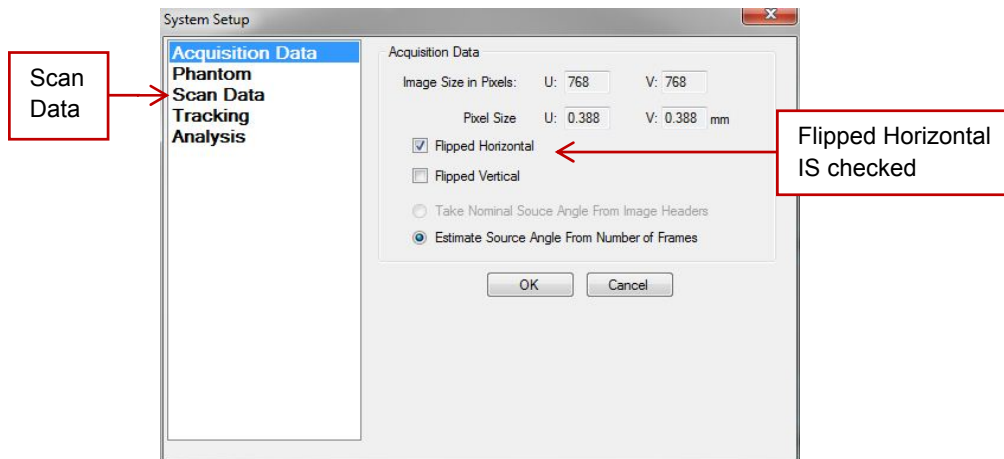

Under the “Scan Data” heading on the left check the value of “Nominal IsoCenter Offset V” to ensure it is a POSITIVE value. The numerical value does not need to match, but it must be positive and not negative. Also check that the “Gantry Rotation” is set to “Clockwise” as shown below. If either of the values are not set as expected, change to be the expected values by removing the negative sign or clicking on the Clockwise radio button. The other numerical values do not matter.

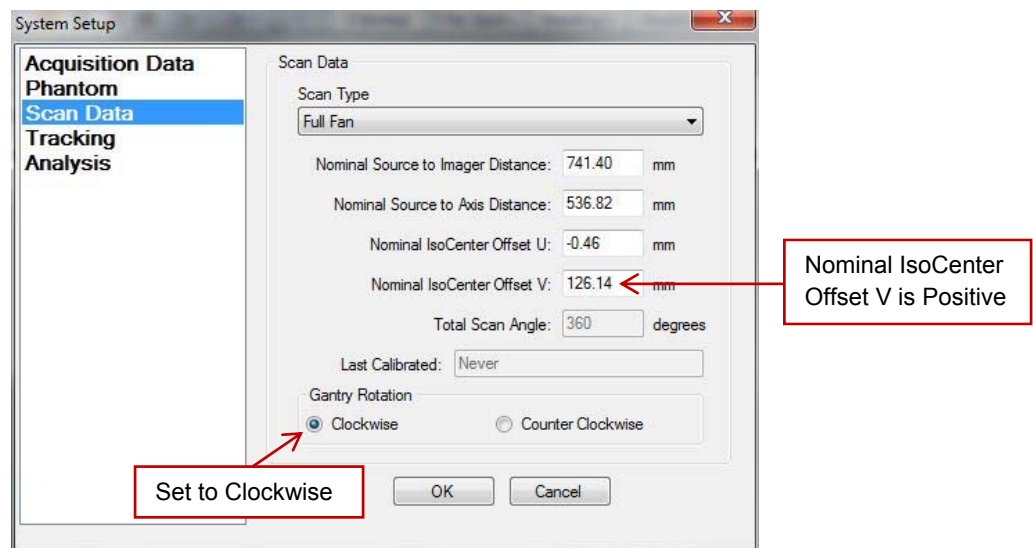

Click OK to close System Setup box.

Click the “Auto Position” button. If all BB’s are enclosed by a blue box, click the “Lock Gates” button.

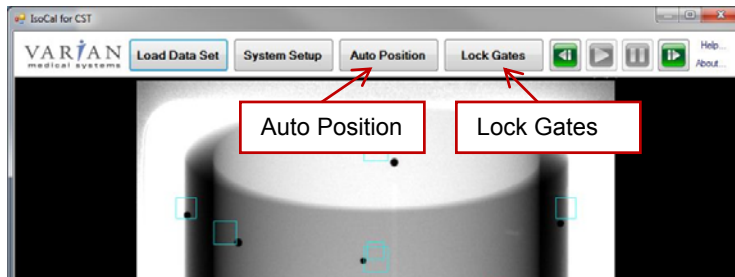

The display should look similar to the following:

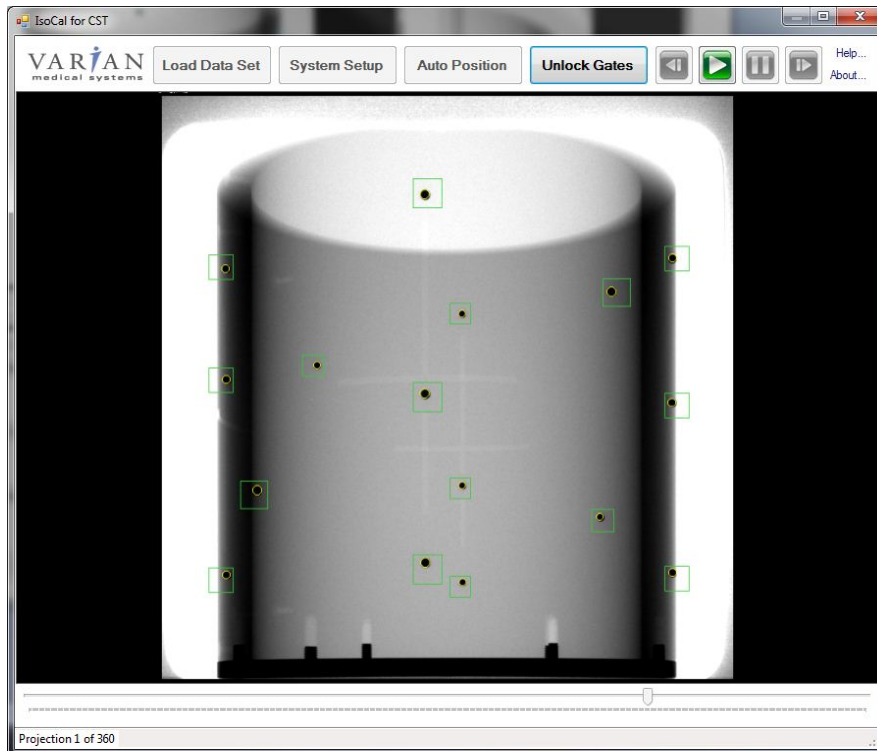

If all of the BB's are not fully encircled with a yellow circle and then boxed in with a green box, then select "Unlock Gates" and proceed to line up all of the BB's within the boxes manually using the slider at the bottom of the image. Move the slider until all BB's are fully contained within a single box, then select "Lock Gates". Perform this until all BB's are fully enclosed with the yellow circle and green box.

IsoCal is now ready to calculate the accurate geometry. In order to start the process, click on the green Play button.

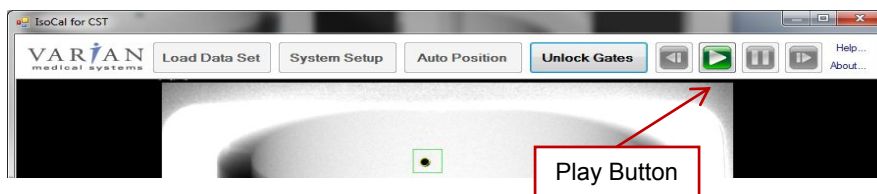

The program will now analyze every of the 360 frames in the geocal raw DICOM dataset and as it does that observe that as few boxes change from green to red and back. No problem if that happens occasionally, but if it happens too often, the IsoCal program will need to be closed and restarted again. The boxes change as the cross each other, if they were red without being near another box, then close the program and restart these instructions from when this program was first opened from the folder on the desktop.

When IsoCal is done analyzing the dataset, the IsoCal Results screen will appear, disregard all numerical values as they may vary from the ones shown below.

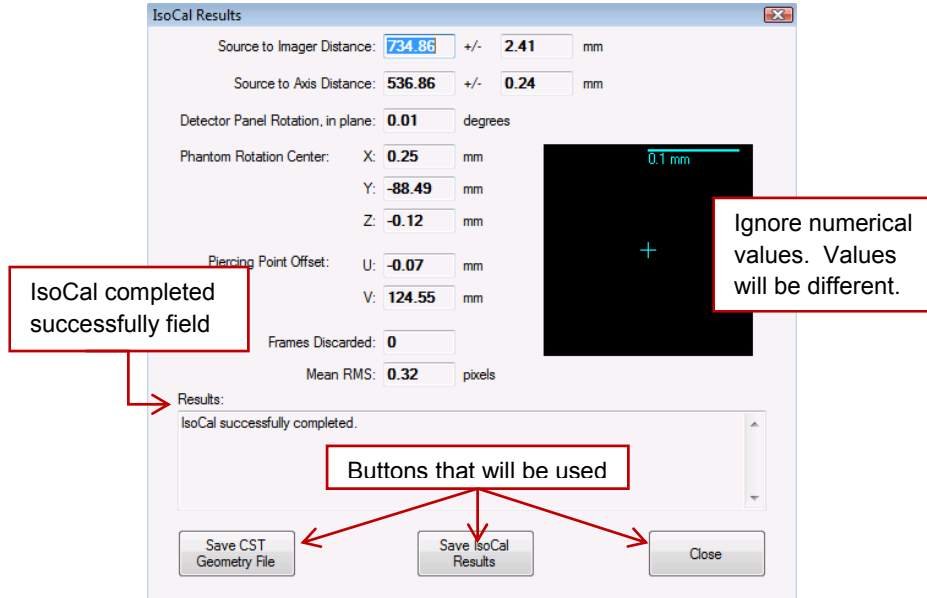

In the “Results:” section, ensure the calibration was completed successfully. If the message “IsoCal successfully completed” does not appear, contact CurveBeam Technical Support for assistance.

Click on the “Save CST Geometry File” button. When prompted for a location, navigate to the Desktop, then to the IsoCal (current version) folder. **For the FIRST scan (Medium FOV), use the filename geometry_768.xml. For the SECOND scan (Large FOV), use the filename geometry_1368.xml to save the file.** Allow the geometry file to replace the existing one, if one is present.

There will then be a pop up asking to save the results for the Full Fan Short Scans. Select “Yes” to the pop up to save them, then navigate to the Desktop then “GeoCal Files” then the folder with the current version of IsoCal folder for this file as well, allow it to overwrite if asked.

Click on “Save IsoCal Results” button. When prompted for a location, navigate to the Desktop, then to the IsoCal (current version) folder. **For the FIRST scan (Medium FOV), use the filename IsoCalResultsMedium.xml. For the SECOND scan (Large FOV), use the filename IsoCalResultsLarge.xml.** Allow the Iso Cal Results file to replace the existing one, if one is present.

Select the “Close” button for the IsoCal Results window.

Close the IsoCal program.

This next section, the geometry.xml file that was just created will need to be edited. The file is in the IsoCal (current version) folder on the desktop. **For the FIRST scan, use the file geometry_768.xml, for the SECOND scan, use the file geometry_1368.xml.** Right click on the appropriate geometry file (for the current scan) and select “Edit with XML Notepad” to open the file, which will look similar to the image below (highlighted values are values of interest to be described below the image):

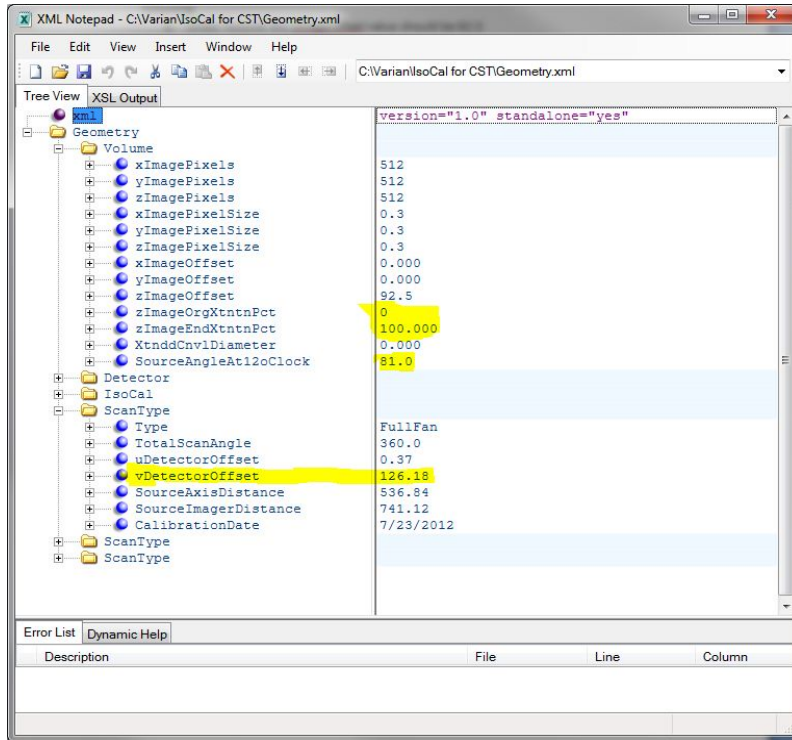

Under the folder name “Volume” locate the value for “zImageOrgXtntnPct”, this value should be “0.0”. If the value is already 0.0, then leave it as is. If it is not 0.0, then change it. Just double click on the value and replace it with the value it should be.

Also under the “Volume” folder, locate “zImageEndXtntnPct” and ensure this value is set to “100.0”. If it is not, then set it to 100.0.

Additionally under the “Volume” folder, locate “SourceAngleAt12oClock” and ensure the value is “81.0” and change it if it is not 81.0.

Under the folder titled “ScanType”, note there are three. Under each of the “ScanType” folders, there is a field named “Type”. Search for the “ScanType” folder where the value for “Type” is already set to “FullFan”. In this section, locate the “vDetectorOffset” field and ensure the value is positive. Do not change the value of this number other than to remove a negative sign, if one is present. If the value is positive then there is nothing further to do.

Save and close the geometry file.

Perform the SECOND Scan (Large FOV) instructions by starting the Geometric Calibration again using the Large FOV Scan.

Only perform the following steps after both Medium and Large FOV scans have been completed.

Next the Geometry files that are used by the Recon Manager will need to be copied and then replaced with the newly created and edited file from above. To do this, open the “Recon Manager Runtime” folder on the desktop. From here, there are two folders that will be accessed. The Configuration folder and the ConfigurationPass2 folder. In both of these two folders, locate the file “Geometry_768.xml” and rename it to “Geometry_768_YYYY_MM_DD.xml” where YYYY is the current year and MM_DD represents the current (today’s) month and date. Then locate the file “Geometry_1368.xml” and rename it to “Geometry_1368_YYYY_MM_DD.xml” where YYYY is the current year and MM_DD represents the current (today’s) month and date. This will need to be done TWICE, once for the Geometry_768.xml and Geometry_1368.xml files in the Configuration folder and once for the same files in the ConfigurationPass2 folder.

Navigate back to the IsoCal (current version) folder that has the newly created and edited Geometry files. Copy both the Geometry_768.xml and the Geometry_1368.xml files. Navigate on the desktop to the “Recon Manager Runtime” folder. The copy of the geometry files will now need to be placed in BOTH the Configuration folder and the ConfigurationPass2 folder inside the “Recon Manager Runtime” folder. So navigate to each folder and right click and select “Paste” to paste a copy of the geometry files in both the Configuration folder and the ConfigurationPass2 folder.

Close the “Recon Manager Runtime” folder.

Close the IsoCal (current version) folder.

Start the Recon Manager Program.

Close the Recon VM window.

Place the Patient Platform in the scanner.

All calibrations are complete.

Quality Assurance Procedures

QA Test Procedures:

The QA test procedures are designed to check for Image Quality, Accuracy of Distance Measurements, and Consistency. These tests can be performed by a PedCAT owner/operator, or any service technician or radiation physicists. It is recommended that this QA test procedure be performed quarterly or if there are any indications of image quality or accuracy issues.

The QA tests will be performed by scanning specified QA phantoms provided by CurveBeam. These include a QA Line Pair/Chamber Phantom and a Water Phantom. Image Data will be captured and assessed for acceptable values. For Assessments to be completed in CubeVue software, please refer to Post Processing of Data in Chapter 6 of this manual.

Image Quality (QA Phantom):

The items assessed for Image Quality will be:

- High Contrast Spatial Resolution measured via line pairs.
- Hounsfield Units (HU) accuracy of 4 Density chambers (Teflon, Acrylic, LDPE, Air)

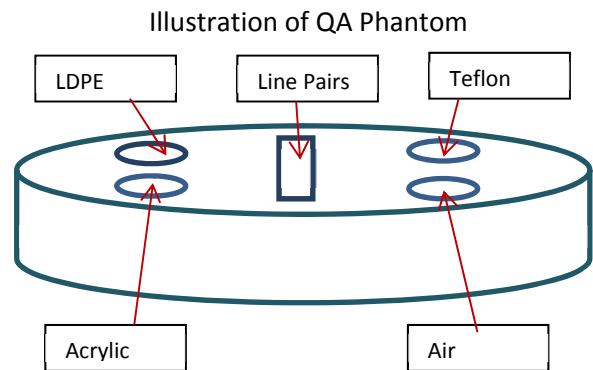
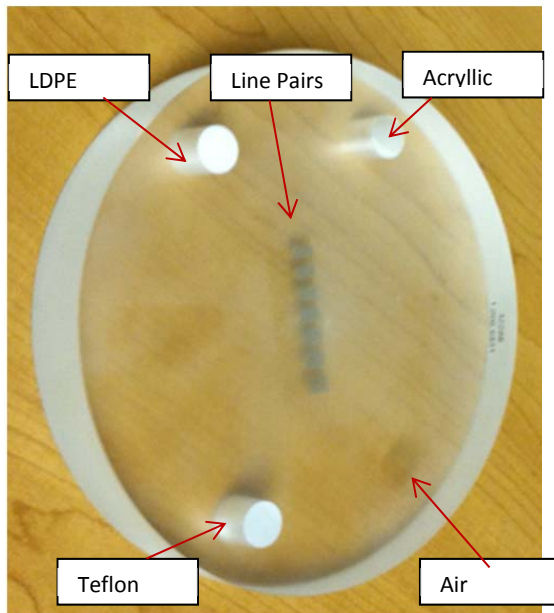

1. Place the QA Phantom on the devices patient platform using the circular positioning guides to center it on the platform.

2. Acquire a CBCT scan of the phantom using a **Medium Field (120 kVp) scan option**.



Advice: Please refer to the Acquiring a Scan section of the manual, Chapter 6, for Acquiring the scan).



WARNING The X-ray device may be dangerous to the Patient and Operator if you do not observe and follow operating instructions. Do not operate this system unless you have received training to perform a procedure

3. Evaluate High Contrast Spatial Resolution: Open the newly captured scan in CubeVue Viewing software and load the acquired scan to visually evaluate the line pairs for high contrast spatial resolution.



Advice: Please refer to Chapter 6 for instructions on use of CubeVue.

- a. Apply the Sharp Filter from within CubeVue – keep this set for all of the remaining QA procedures.
 - b. Change the slab thickness to the smallest thickness in the axial window – keep this set for all of the remaining QA procedures.
 - c. Observe the line pairs in the CubeVue Review/MPR Tab's axial view. (Refer to Chapter 6 for instructions on use of CubeVue). The axial image should be centered on the line pairs, use coronal and sagittal views to approximate the center of the line pairs (height), then view the line pairs in the axial window.
 - d. The expected result should be 9 line pairs per cm or better. The line pairs start at 8 line pairs, so the second set of line pairs is 9 line pairs per cm, third set is 10 line pairs per cm, and so forth.
 - e. Visually verify that there is definition present for each of the lines in pair 9 or higher.
4. Evaluate Hounsfield (HU) Accuracy:
 - a. On the axial view, measure the Hounsfield Units value of each density chamber. The results should fall within the below ranges.



Advice: *Keep the HU circle off the borders of the chambers and use the small circles under the HU menu in CubeVue. Move the HU regions so that the first one on the list in CubeVue in the top right corner is the Air region, the second is Acrylic and continue around the circle. This then allows for the CubeVue top right HU Values to line up with the HU value order of the list below.*

| <u>Density Material</u> | <u>Expected HU value Ranges</u> |
|-------------------------------|---------------------------------|
| AIR (black chamber): | -1100 to -900 |
| ACRYLIC (light gray chamber): | -50 to 200 |
| LDPE (dark gray chamber): | -250 to -50 |
| TEFLON (white chamber): | 700 to 1200 |

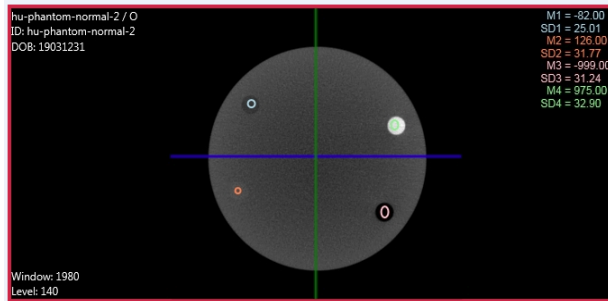

Distance Measurement Accuracy (QA Phantom):

Evaluate Distance Measurement Accuracy: In the currently open QA Phantom scan, Zoom into the Axial View's line pairs and make a distance measurement, using the Distance Tool, from one end of the line pair set to the other end of the line pair set. The distance should be between 41.0 - 42.5 mm.

Consistency/Uniformity (Water Phantom):

To evaluate consistency, we will image the Water Phantom. Water phantom image may vary from what was delivered with your machine.



1. The water phantom should be filled all the way to the top with distilled water, allow a bit of air space at the top to close the container.

2. Place the water phantom on the platform and ensure it is centered using the laser lights and circles on the patient platform.

3. Acquire a new scan of the water phantom using a **Medium Field (120 kVp) scan option**.



Advice: Please refer to the Operations: Acquisition section of the manual, Chapter 6, for instructions on acquiring the scan.

4. Once the data is captured, it can be evaluated in the CubeVue, viewing software. Open the dataset to the Review/MPR Tab's Axial View. Apply the Sharp Filter and change the slab thickness on the axial window to the smallest possible slab size.

5. *Noise Level Test:* from the axial view, use the large Hounsfield circular measurements from within CubeVue and move them so that one is in the center of the water.

The Value should fall in the below range:

Water: -150 to 150

6. *Uniformity Test:* move the other 4 HU large circular measurements into the four quadrants, with the one from the prior step still in the center of the axial image. Note the Mean of each measurement. The mean of each quadrant measurement should be within 250 HU's from the center measurement mean.

Radiation Output Test:

It is recommended that a check of the kVp(eff) and Radiation Output of the X-ray source be performed annually by a qualified Physicist. The incident Absorbed Dose at the detector may be measured using a dosimeter. Tests are performed to assess output value and to check for tube output consistency and timer accuracy.

1. Attach a dosimeter to the detector such that the sensor is positioned where the vertical and lower horizontal laser lights intersect.
2. Perform a Standard scan of 20 cm diameter x 20 cm height, 0.3 voxel (Procedure Name: Medium Field (120kVp)) and record the time and dose from the meter.



WARNING The X-ray device may be dangerous to the Patient and Operator if you do not observe and follow operating instructions. Do not operate this system unless you have received training to perform a procedure

CHAPTER 5: Radiation Environment Survey

Scatter Measurements:

All data was acquired using two Technical Associates Mark V integrating ion chamber meters. Data was acquired in concentric circles of radii listed in the tables. Foot phantoms (one or two as indicated) were placed in the beam to act as the scattering agent. The position of highest dose was determined to be approximately 1 foot off the floor. Shielding and dose calculations at this location will be slightly conservative as dose received to the lower extremities is not considered whole body dose. Measurements were made at 0, 45, 90, 180, 225, 270 and 315 degrees. Where the patient steps into the system is 0 degrees. The two calibrated integrating ion chambers were used to measure dose resulting from scatter at each location. These meters were verified to have excellent agreement. The integration time for each mode was the entire scan time.

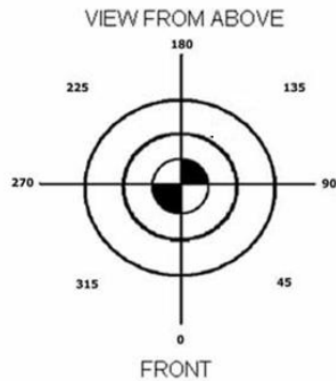

Scatter intensity drops off approximately in accordance with the inverse square law. Scatter measurements were similar to other units of this type given slight variations in kVp, mA, and rotation time. The levels as measured should pose no unusual problems in shielding. The angle with the highest scatter measurements for all scans was 315 degrees.

Dose Profile:

Dose Profile was determined with a ~1 mm thick solid state detector. The profile for the small field size was determined 1 cm increments in the PMMA phantom. The dose profile for the large field size was determined in air as the phantom material was not long enough to reliably encompass the entire profile.

CTDI:

CTDI measurements were made in the 16 cm diameter PMMA phantom. Measurements were made at the center and the periphery of the phantom. CTDI_w (CTDI_{vol}) was determined by routine means.

DATA for Scatter, Dose and CTDI:

Scatter Measurements - Center Mode (Small Patient: Medium Field (100kVp))

Unit: PedCat **Mode:** Center, 2 foot phantoms in beam
Time: 16 sec. **Field Size:** Large
kVp: 100 **mA:** 5
Pulses/Sec: 30 **Pulse dur:** 0.012 sec

Measurements at locations equidistant from phantom location

| Location (Degrees) | Distance in (ft.) | Exposure (mR) | Exposure (uR) | Exposure uR/mAs | 10 scans/wk. mR/week | 25 scans/wk. mR/week | 50 scans/wk. mR/week |
|--------------------|-------------------|---------------|---------------|-----------------|----------------------|----------------------|----------------------|
| 0 | 3 | 0.115 | 115.0 | 3.99 | 1.150 | 2.875 | 5.750 |
| | 6 | 0.023 | 23.0 | 0.80 | 0.230 | 0.575 | 1.150 |
| | 9 | 0.008 | 8.0 | 0.28 | 0.080 | 0.200 | 0.400 |
| 45 | 3 | 0.105 | 105.0 | 3.65 | 1.050 | 2.625 | 5.250 |
| | 6 | 0.022 | 22.0 | 0.76 | 0.220 | 0.550 | 1.100 |
| | 9 | 0.008 | 8.0 | 0.28 | 0.080 | 0.200 | 0.400 |
| 90 | 3 | 0.101 | 101.0 | 3.51 | 1.010 | 2.525 | 5.050 |
| | 6 | 0.023 | 23.0 | 0.80 | 0.230 | 0.575 | 1.150 |
| | 9 | 0.008 | 8.0 | 0.28 | 0.080 | 0.200 | 0.400 |
| 135 | 3 | 0.098 | 98.0 | 3.40 | 0.980 | 2.450 | 4.900 |
| | 6 | 0.020 | 20.0 | 0.69 | 0.200 | 0.500 | 1.000 |
| | 9 | 0.007 | 7.0 | 0.24 | 0.070 | 0.175 | 0.350 |
| 180 | 3 | 0.084 | 84.0 | 2.92 | 0.840 | 2.100 | 4.200 |
| | 6 | 0.016 | 16.0 | 0.56 | 0.160 | 0.400 | 0.800 |
| | 9 | 0.005 | 5.0 | 0.17 | 0.050 | 0.125 | 0.250 |
| 225 | 3 | 0.094 | 94.0 | 3.26 | 0.940 | 2.350 | 4.700 |
| | 6 | 0.018 | 18.0 | 0.63 | 0.180 | 0.450 | 0.900 |
| | 9 | 0.007 | 7.0 | 0.24 | 0.070 | 0.175 | 0.350 |
| 270 | 3 | 0.117 | 117.0 | 4.06 | 1.170 | 2.925 | 5.850 |
| | 6 | 0.024 | 24.0 | 0.83 | 0.240 | 0.600 | 1.200 |
| | 9 | 0.009 | 9.0 | 0.31 | 0.090 | 0.225 | 0.450 |
| 315 | 3 | 0.124 | 124.0 | 4.31 | 1.240 | 3.100 | 6.200 |
| | 6 | 0.017 | 17.0 | 0.59 | 0.170 | 0.425 | 0.850 |
| | 9 | 0.009 | 9.0 | 0.31 | 0.090 | 0.225 | 0.450 |
| 1m above/below | | 0.172 | 172.0 | 5.97 | 1.720 | 4.300 | 8.600 |

Ion Chamber Instruments: TA TBM-IC Mark V S/N 11982, Calibrated 7/12/11

TA TBM-IC Mark V S/N 9404, Calibrated 3/5/11

*Scattered dose in the down direction could not be measured due to practical considerations of machine size, weight, etc. Dose in the down direction is conservatively assumed to be the same as in the up direction. This is considered conservative as machine structural components will attenuate the scattered beam significantly.

Scatter Measurements - Center Mode (Medium Field (120kVp))

Unit: PedCat Mode: Center, 2 foot phantoms in beam
 Time: 16 sec. Field Size: Large
 kVp: 120 mA: 5
 Pulses/Sec: 30 Pulse dur: 0.012 sec

Measurements at locations equidistant from phantom location

| Location (Degrees) | Distance in (ft.) | Exposure (mR) | Exposure (uR) | Exposure uR/mAs | 10 scans/wk. mR/week | 25 scans/wk. mR/week | 50 scans/wk. mR/week |
|--------------------|-------------------|---------------|---------------|-----------------|----------------------|----------------------|----------------------|
| 0 | 3 | 0.214 | 214.0 | 7.43 | 2.140 | 5.350 | 10.700 |
| | 6 | 0.050 | 50.0 | 1.74 | 0.500 | 1.250 | 2.500 |
| | 9 | 0.021 | 21.0 | 0.73 | 0.210 | 0.525 | 1.050 |
| 45 | 3 | 0.226 | 226.0 | 7.85 | 2.260 | 5.650 | 11.300 |
| | 6 | 0.051 | 51.0 | 1.77 | 0.510 | 1.275 | 2.550 |
| | 9 | 0.021 | 21.0 | 0.73 | 0.210 | 0.525 | 1.050 |
| 90 | 3 | 0.208 | 208.0 | 7.22 | 2.080 | 5.200 | 10.400 |
| | 6 | 0.048 | 48.0 | 1.67 | 0.480 | 1.200 | 2.400 |
| | 9 | 0.019 | 19.0 | 0.66 | 0.190 | 0.475 | 0.950 |
| 135 | 3 | 0.192 | 192.0 | 6.67 | 1.920 | 4.800 | 9.600 |
| | 6 | 0.043 | 43.0 | 1.49 | 0.430 | 1.075 | 2.150 |
| | 9 | 0.018 | 18.0 | 0.63 | 0.180 | 0.450 | 0.900 |
| 180 | 3 | 0.161 | 161.0 | 5.59 | 1.610 | 4.025 | 8.050 |
| | 6 | 0.035 | 35.0 | 1.22 | 0.350 | 0.875 | 1.750 |
| | 9 | 0.013 | 13.0 | 0.45 | 0.130 | 0.325 | 0.650 |
| 225 | 3 | 0.206 | 206.0 | 7.15 | 2.060 | 5.150 | 10.300 |
| | 6 | 0.041 | 41.0 | 1.42 | 0.410 | 1.025 | 2.050 |
| | 9 | 0.016 | 16.0 | 0.56 | 0.160 | 0.400 | 0.800 |
| 270 | 3 | 0.216 | 216.0 | 7.50 | 2.160 | 5.400 | 10.800 |
| | 6 | 0.050 | 50.0 | 1.74 | 0.500 | 1.250 | 2.500 |
| | 9 | 0.019 | 19.0 | 0.66 | 0.190 | 0.475 | 0.950 |
| 315 | 3 | 0.237 | 237.0 | 8.23 | 2.370 | 5.925 | 11.850 |
| | 6 | 0.052 | 52.0 | 1.81 | 0.520 | 1.300 | 2.600 |
| | 9 | 0.022 | 22.0 | 0.76 | 0.220 | 0.550 | 1.100 |
| 1m above/below | | 0.318 | 318.0 | 11.04 | 3.180 | 7.950 | 15.900 |

Ion Chamber Instruments: TA TBM-IC Mark V S/N 11982, Calibrated 7/12/11

TA TBM-IC Mark V S/N 9404, Calibrated 3/5/11

*Scattered dose in the down direction could not be measured due to practical considerations of machine size, weight, etc. Dose in the down direction is conservatively assumed to be the same as in the up direction. This is considered conservative as machine structural components will attenuate the scattered beam significantly.

Scatter Measurements - Offset Mode (Small Patient: Large Field (100kVp))

Unit: PedCat **Mode:** Offset, 2 foot phantoms, 2 rotations
Time: 32 sec. **Field Size:** Large
kVp: 100 **mA:** 5
Pulses/Sec: 30 **Pulse dur:** 0.012 sec

Measurements at locations equidistant from phantom location

| Location (Degrees) | Distance in (ft.) | Exposure (mR) | Exposure (uR) | Exposure uR/mAs | 10 scans/wk. mR/week | 25 scans/wk. mR/week | 50 scans/wk. mR/week |
|--------------------|-------------------|---------------|---------------|-----------------|----------------------|----------------------|----------------------|
| 0 | 3 | 0.210 | 210.0 | 3.65 | 2.100 | 5.250 | 10.500 |
| | 6 | 0.041 | 41.0 | 0.71 | 0.410 | 1.025 | 2.050 |
| | 9 | 0.015 | 15.0 | 0.26 | 0.150 | 0.375 | 0.750 |
| 45 | 3 | 0.199 | 199.0 | 3.45 | 1.990 | 4.975 | 9.950 |
| | 6 | 0.040 | 40.0 | 0.69 | 0.400 | 1.000 | 2.000 |
| | 9 | 0.015 | 15.0 | 0.26 | 0.150 | 0.375 | 0.750 |
| 90 | 3 | 0.177 | 177.0 | 3.07 | 1.770 | 4.425 | 8.850 |
| | 6 | 0.037 | 37.0 | 0.64 | 0.370 | 0.925 | 1.850 |
| | 9 | 0.014 | 14.0 | 0.24 | 0.140 | 0.350 | 0.700 |
| 135 | 3 | 0.173 | 173.0 | 3.00 | 1.730 | 4.325 | 8.650 |
| | 6 | 0.032 | 32.0 | 0.56 | 0.320 | 0.800 | 1.600 |
| | 9 | 0.010 | 10.0 | 0.17 | 0.100 | 0.250 | 0.500 |
| 180 | 3 | 0.128 | 128.0 | 2.22 | 1.280 | 3.200 | 6.400 |
| | 6 | 0.024 | 24.0 | 0.42 | 0.240 | 0.600 | 1.200 |
| | 9 | 0.008 | 8.0 | 0.14 | 0.080 | 0.200 | 0.400 |
| 225 | 3 | 0.180 | 180.0 | 3.13 | 1.800 | 4.500 | 9.000 |
| | 6 | 0.031 | 31.0 | 0.54 | 0.310 | 0.775 | 1.550 |
| | 9 | 0.012 | 12.0 | 0.21 | 0.120 | 0.300 | 0.600 |
| 270 | 3 | 0.191 | 191.0 | 3.32 | 1.910 | 4.775 | 9.550 |
| | 6 | 0.039 | 39.0 | 0.68 | 0.390 | 0.975 | 1.950 |
| | 9 | 0.016 | 16.0 | 0.28 | 0.160 | 0.400 | 0.800 |
| 315 | 3 | 0.216 | 216.0 | 3.75 | 2.160 | 5.400 | 10.800 |
| | 6 | 0.044 | 44.0 | 0.76 | 0.440 | 1.100 | 2.200 |
| | 9 | 0.018 | 18.0 | 0.31 | 0.180 | 0.450 | 0.900 |
| 1 m above/below | | 0.272 | 272.0 | 4.72 | 2.720 | 6.800 | 13.600 |

Ion Chamber Instruments: TA TBM-IC Mark V S/N 11982, Calibrated 7/12/11

TA TBM-IC Mark V S/N 9404, Calibrated 3/5/11

*Scattered dose in the down direction could not be measured due to practical considerations of machine size, weight, etc. Dose in the down direction is conservatively assumed to be the same as in the up direction. This is considered conservative as machine structural components will attenuate the scattered beam significantly.

Scatter Measurements - Offset Mode (Large Field (120kVp))

Unit: PedCat **Mode:** Offset, 2 foot phantoms, 2 rotations
Time: 32 sec. **Field Size:** Large
kVp: 120 **mA:** 5
Pulses/Sec: 30 **Pulse dur:** 0.012 sec

| Location (Degrees) | Distance in Ft (m) | Exposure (mR) | Exposure (uR) | Exposure uR/mAs | 10 scans/wk. mR/week | 25 scans/wk. mR/week | 50 scans/wk. mR/week |
|--------------------|--------------------|---------------|---------------|-----------------|----------------------|----------------------|----------------------|
| 0 | 3 | 0.395 | 395.0 | 6.86 | 3.950 | 9.875 | 19.750 |
| | 6 | 0.095 | 95.0 | 1.65 | 0.950 | 2.375 | 4.750 |
| | 9 | 0.038 | 38.0 | 0.66 | 0.380 | 0.950 | 1.900 |
| 45 | 3 | 0.357 | 357.0 | 6.20 | 3.570 | 8.925 | 17.850 |
| | 6 | 0.081 | 81.0 | 1.41 | 0.810 | 2.025 | 4.050 |
| | 9 | 0.032 | 32.0 | 0.56 | 0.320 | 0.800 | 1.600 |
| 90 | 3 | 0.359 | 359.0 | 6.23 | 3.590 | 8.975 | 17.950 |
| | 6 | 0.087 | 87.0 | 1.51 | 0.870 | 2.175 | 4.350 |
| | 9 | 0.035 | 35.0 | 0.61 | 0.350 | 0.875 | 1.750 |
| 135 | 3 | 0.327 | 327.0 | 5.68 | 3.270 | 8.175 | 16.350 |
| | 6 | 0.071 | 71.0 | 1.23 | 0.710 | 1.775 | 3.550 |
| | 9 | 0.027 | 27.0 | 0.47 | 0.270 | 0.675 | 1.350 |
| 180 | 3 | 0.290 | 290.0 | 5.03 | 2.900 | 7.250 | 14.500 |
| | 6 | 0.062 | 62.0 | 1.08 | 0.620 | 1.550 | 3.100 |
| | 9 | 0.020 | 20.0 | 0.35 | 0.200 | 0.500 | 1.000 |
| 225 | 3 | 0.348 | 348.0 | 6.04 | 3.480 | 8.700 | 17.400 |
| | 6 | 0.064 | 64.0 | 1.11 | 0.640 | 1.600 | 3.200 |
| | 9 | 0.020 | 20.0 | 0.35 | 0.200 | 0.500 | 1.000 |
| 270 | 3 | 0.398 | 398.0 | 6.91 | 3.980 | 9.950 | 19.900 |
| | 6 | 0.089 | 89.0 | 1.55 | 0.890 | 2.225 | 4.450 |
| | 9 | 0.035 | 35.0 | 0.61 | 0.350 | 0.875 | 1.750 |
| 315 | 3 | 0.397 | 397.0 | 6.89 | 3.970 | 9.925 | 19.850 |
| | 6 | 0.084 | 84.0 | 1.46 | 0.840 | 2.100 | 4.200 |
| | 9 | 0.033 | 33.0 | 0.57 | 0.330 | 0.825 | 1.650 |
| 1 m above/below | | 0.503 | 503.0 | 8.73 | 5.030 | 12.575 | 25.150 |

Ion Chamber Instruments: TA TBM-IC Mark V S/N 11982, Calibrated 7/12/11

TA TBM-IC Mark V S/N 9404, Calibrated 3/5/11

*Scattered dose in the down direction could not be measured due to practical considerations of machine size, weight, etc. Dose in the down direction is conservatively assumed to be the same as in the up direction. This is considered conservative as machine structural components will attenuate the scattered beam significantly.

Scatter Measurement – 22” Directly above patient opening

This measurement was taken using the same Ion Chamber instruments noted above but located 22 inches above the patient platform which correlates to the smallest patients groin location. Two foot phantoms were located in the patient opening for this measurement.

Pulses per second: 30

Field size: large

mA: 5

Pulse duration: 0.012 seconds

| Mode, kVp | Scan time, seconds | mR at 56cm |
|--------------|--------------------|------------|
| Center, 100 | 16 | 0.83 |
| Offset, 100 | 32 | 1.53 |
| Mean for 100 | | 1.18 |
| Center, 120 | 16 | 1.30 |
| Offset, 120 | 32 | 2.42 |
| Mean for 120 | | 1.86 |

DOSE AND SENSITIVITY PROFILE, SMALL FIELD SIZE

(HIGH RESOLUTION MODE)

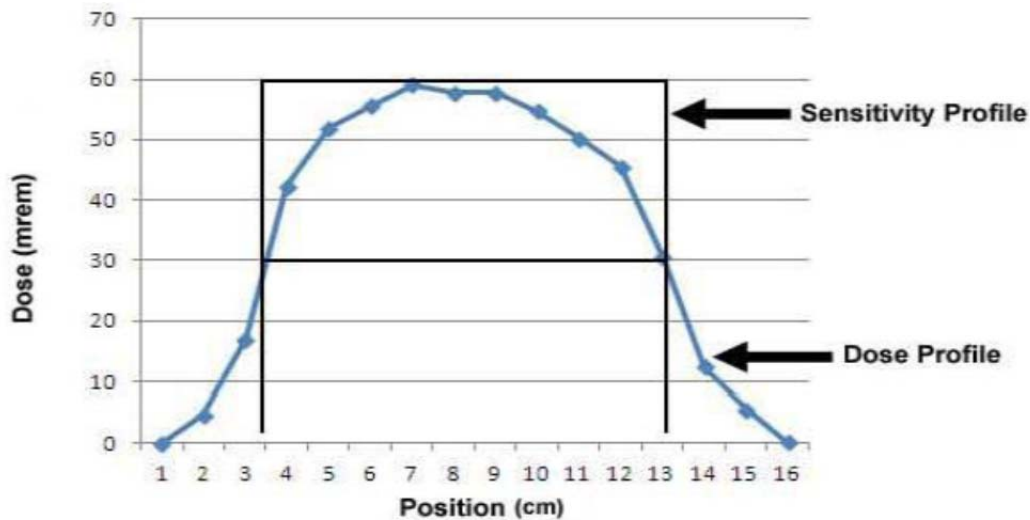

DOSE AND SENSITIVITY PROFILE, LARGE FIELD SIZE (CENTER AND OFFSET MODES)

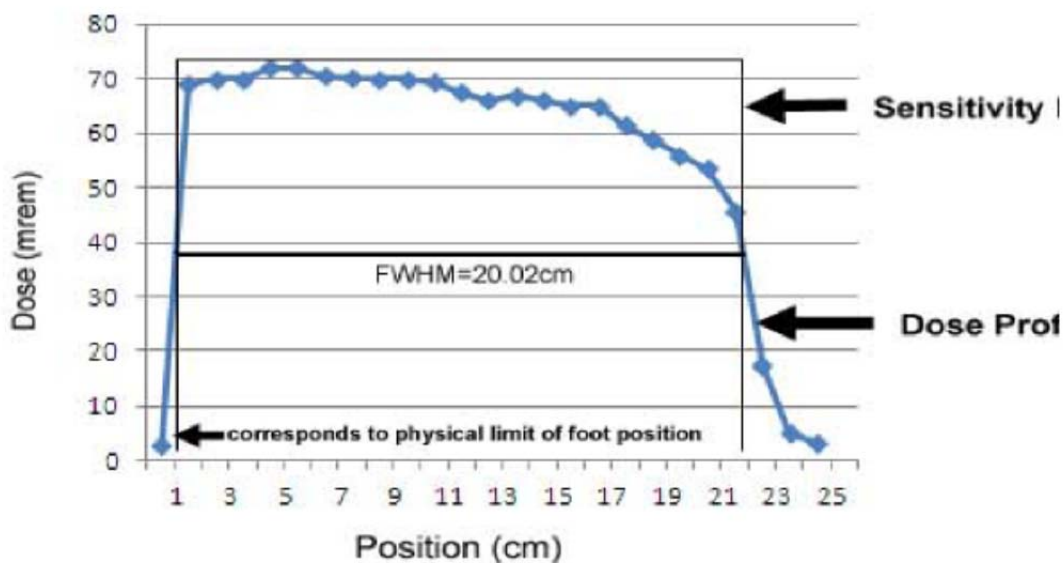

Dose Measurement PedCat - CTDIvol (mGy)

| Procedure | TIME OF SCAN (s) | kVp | mA | HEIGHT (cm) | CTDI – free air (mGy) | CTDI100 Center (mGY) | CTDI100 Peripheral (mGy) | CTDIvol (mGy)* |
|-----------------|------------------|-----|----|-------------|-----------------------|----------------------|--------------------------|----------------|
| Center Small Pt | 16 | 100 | 5 | 20 | 0.70 | 0.421 | 0.497 | 0.47 +/- 0.01 |
| Center | 16 | 120 | 5 | 20 | 1.04 | 0.80 | 0.931 | 0.89 +/- 0.02 |
| Offset Small Pt | 32 | 100 | 5 | 20 | 1.04 | 0.627 | 0.626 | 0.63 +/- 0.02 |
| Offset | 32 | 120 | 5 | 20 | 1.63 | 1.25 | 1.081 | 1.10 +/- 0.03 |

Center Small Pt = Small Patient: Medium Field (100kVp) procedure option.

Center = Medium Field (120kVp) procedure option.

Offset Small Pt = Small Patient: Large Field (100kVp) procedure option.

Offset = Large Field (120kVp) procedure option

Dosimetry was determined as described in IEC 60601-2-44 using A 16cm PMMA phantom as described in that document. Stated errors are based on the stated calibration error of the dosimetry system used and propagation of that error through the multiple measurements and calculations made to determine CTDIvol.

Dosimetry system: RTI Barracuda S/N BC1-04080043 with Radcal 10X5-3CT probe, free air measurements made with RTI dose profile probe.

CTDIw is CTDIvol as the pitch is 1 and helical scans are not possible on this unit.

Typical scans of similar tube current-time product (mAs) on a traditional, “full gantry” CT with the same phantom result in the following CTDI Values at resolutions of 7-9 lp/cm:

Dose Measurement - Full Gantry Units- CTDIvol (mGy)

| Make/Model | TIME | | | | Collimation (mm) | CTDIvol (mGy) |
|--------------------|-------------|-------|-------|-----|------------------|---------------|
| | OF SCAN (s) | mA | mAs | kVp | | |
| Siemens Somotome | 0.5 | 252 | 126 | 100 | 12 | 7.46 |
| GE Bright Speed 16 | 0.5 | 160 | 80 | 100 | 20 | 5.7 |
| Philips mX8000 | 0.5 | 400 | 200 | 90 | 10 | 14.0 |
| Philips Power 16 | 0.58 | 325.7 | 190 | 120 | 12 | 29.0 |
| Philips Power 16 | 0.50 | 157.6 | 78.78 | 120 | 24 | 7.4 |
| GE VCT | 1 | 210 | 210 | 120 | 20 | 18.74 |

Dose Measurement by Patient Size PedCat - CTDIvol (mGy)

| Procedure | AGE/SIZE | TIME | | | | HEIGHT (cm) | CTDIvol (mGy) |
|-----------------|-------------|-------------|----|-----|-----|-------------|---------------|
| | | OF SCAN (s) | mA | mAs | kVp | | |
| Center Small Pt | Child/Small | 16 | 5 | 80 | 100 | 20 | 0.47 +/- 0.01 |
| Center | Adult M/L | 16 | 5 | 80 | 120 | 20 | 0.89 +/- 0.02 |
| Offset Small Pt | Child/Small | 32 | 5 | 160 | 100 | 20 | 0.63 +/- 0.02 |
| Offset | Adult M/L | 32 | 5 | 160 | 120 | 20 | 1.10 +/- 0.03 |

Dose Measurement by Scan Procedure/Protocol: DAP (Dose Area Product) (mGy*cm²)

| PedCAT Procedure/Protocol | mGy*cm ² |
|---------------------------|---------------------|
| Medium FOV, 120 kVp | 803 |
| Medium FOV, 100 kVp | 492 |
| Large FOV, 120 kVp | 1484 |
| Large FOV, 100 kVp | 897 |

Dosimetry Meter: RadCal PDC (patient dose calibrator), Monrovia, CA. Measurements obtained with DAP meter flush to the image receptor.

CT#, Noise, Uniformity, and MTF Measurements

| Imaging Procedure | CT# - Water Center of phantom | | Noise | | Uniformity Range of CT numbers | | MTF=0.1 Limiting resolution | |
|--------------------------------------|-------------------------------|-----------|-------|-----|-----------------------------------|------|--------------------------------|-------|
| | Meas. | Std | Meas. | Std | Center to any Edge | Std | mm | LP/cm |
| Medium Field (120kVp) | -59 | 0 +/- 150 | 25.8 | <50 | 108 | <250 | 0.50 | 10 |
| Medium Field, Sharp Filter (120kVp) | -23 | 0 +/- 150 | 28.44 | <50 | 74 | <250 | 0.50 | 10 |
| Small Patient: Medium Field (100kVp) | 40 | 0 +/- 150 | 34.19 | <50 | 117 | <250 | 0.50 | 10 |
| Large Field (120kVp) | 50 | 0 +/- 150 | 16.11 | <50 | 13 | <250 | 0.56 | 9 |
| Small Patient: Large Field (100kVp) | -6 | 0 +/- 150 | 23.8 | <50 | 32 | <250 | 0.56 | 9 |

Standards as established by CurveBeam.

Measurements made on 15 cm water equivalent phantom

Sharp and normal refer to the type of reconstruction kernel used

Reconstructed Slice Thickness

| Imaging Procedure | Reconstructed Slice Thickness | | Limit |
|--------------------------------------|-------------------------------|----------|-----------|
| | Set | Measured | |
| Medium Field (120kVp) | 1 | 1.5 | 0.5 - 1.5 |
| Medium Field (120kVp) | 2 | 2.5 | 1 - 3 |
| Medium Field (120kVp) | 8 | 8.5 | 7 - 9 |
| Large Field (120kVp) | 1 | 1.5 | 0.5 - 1.5 |
| Large Field (120kVp) | 3.5 | 4 | 2.5 - 4.5 |
| Large Field (120kVp) | 8.5 | 9 | 7.5 - 9.5 |
| Small Patient: Medium Field (100kVp) | 1 | 1.5 | 0.5 - 1.5 |
| Small Patient: Medium Field (100kVp) | 3.4 | 3.5 | 2.4 - 4.4 |
| Small Patient: Medium Field (100kVp) | 10 | 11 | 9 - 11 |
| Small Patient: Large Field (100kVp) | 1 | 1.5 | 0.5 - 1.5 |
| Small Patient: Large Field (100kVp) | 3.5 | 4 | 2.5 - 4.5 |
| Small Patient: Large Field (100kVp) | 8.4 | 9 | 7.4 - 9.4 |

All measurements were made on a standard ACR accreditation phantom.

Limits taken from IEC 61223-3-5.

All measurements made with normal reconstruction kernel.

Z-axis point spread function:

The pedCAT has a fixed and rigid patient positioning platform that does not incorporate any table motion or indexing (no “table pitch”). The detector panel has a square shape, while the pixels on the panels are square shaped as well. The raw projections are acquired in a single 360 degree orbit, thus covering the entire Field of View (FOV) height in one rotation. This results in isotropic voxels in the reconstructed volume, hence the same spatial resolution in the z-axis as in the x-y plane. Due to this projection geometry, calculation of a separate z-axis point spread function should not be applicable.

Recommended Operating Requirements:

Local agencies or government bodies or international standards may dictate requirements for installation of the system in order to protect personnel and the public from exposure from the radiological output of the device. Consult your local agencies, government bodies, or international standards for actual requirements which apply.

It is recommended that a qualified Physicist or Radiologist determine where appropriate, the applicable lead shielding to be installed in the area around the system equipment. Below are some other common requirements that may apply to your location:

- The Operations computer (server) and X-ray Operator should be located behind a properly shielded permanent barrier. A viewing window should be present to enable the X-ray Operator to view the Patient and operate the computer while the exposure is present.
- Operators should consider the use of a lead apron to protect the anatomical areas of the medical personnel working in the areas exposed to radiation.
- The Operator Control Box and Acquisition Computer shall be located within 1 meter [3.28 ft] from a door. If not, an interlocked door may be required.
- A room door may be required.
- Radiation warning signs may be required next to the entrance to the room.
- A Warning light may be required by the entrance to the room.
- A shielding plan should be performed where the system is being installed. Some local agencies or government bodies require that a shielding plan be conducted by a qualified Physicist or Radiologist and a copy of the shielding plan be submitted and approved prior to installation of the system.
- An area radiation survey by a qualified physicist or Radiologist may then be required within 30 days of initial clinical use of the system. This survey may be required to be submitted to the local agency or government body

Site Survey TYPICAL pedCAT LAYOUT

Location of all "red box" items must be defined before installation

Operator to maintain at least 3 meters from unit during scan. Control box to be mounted outside of room. If mounting inside room lead shield must be used. When using lead shield it must be between the operator and unit. A smaller room can be used as long as a shielding plan is developed and recommended by a Physicist.

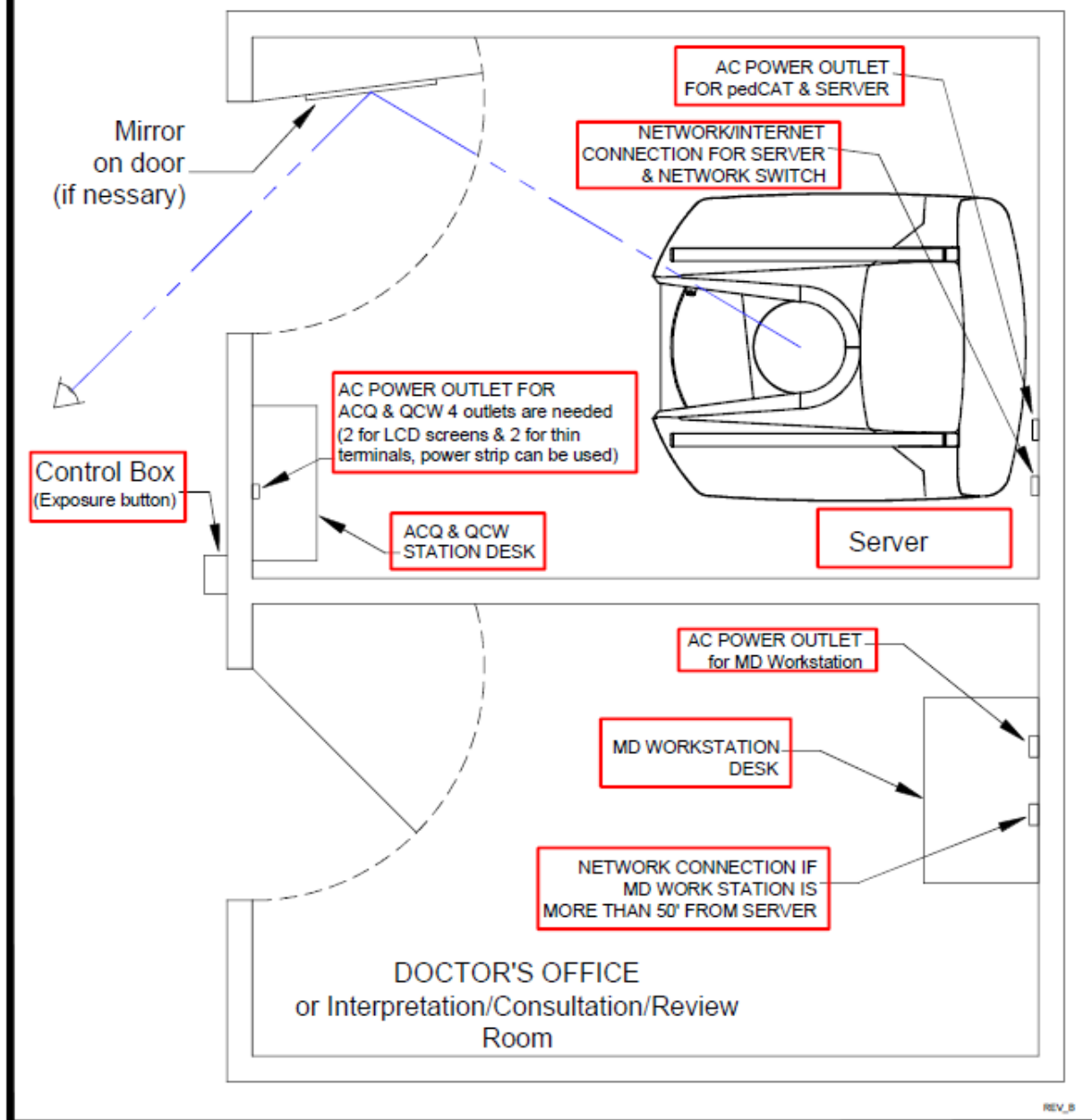

Effective Dose to Patient Measurements (Micro Sieverts):

| pedCAT Scan: Imaging Procedure | Effective Dose in Micro Sieverts (μSv) |
|--|---|
| Medium Field of View (<i>partial single foot</i>) | |
| Adult (18+) 100 kVp | 1 - 2 |
| Adult (18+) 120 kVp | 1 - 2 |
| Child (around 10) 100 kVp | 4 - 7 |
| Child (around 10) 120 kVp | 4 - 7 |
| Large Field of View | |
| Adult (18+) 100 kVp | |
| Single Foot | 2 - 3 |
| 2 Feet | 3 - 5 |
| Adult (18+) 120 kVp | |
| Single Foot | 2 - 3 |
| 2 Feet | 3 - 5 |
| Child (around 10) 100 kVp | |
| Single Foot | 5 - 9 |
| 2 Feet | 9 - 14 |
| Child (around 10) 120 kVp | |
| Single Foot | 5 - 9 |
| 2 Feet | 9 - 14 |

Report on CurveBeam CBCT Foot Dosimetry

John Ludlow, DDS, MS, FDS RCSEd

Methods:

A custom tissue equivalent anthropomorphic phantom of the foot and ankle was constructed (The Phantom laboratory, Salem, NY). The model was constructed in 25 mm horizontally sliced layers allowing separation and specific localization of dosimeters within each layer.

Slots were drilled in the upper surface of the layers to accommodate placement of NanoDot OSL dosimeters. Slots were located in and on tissues included in the weighted tissues used in the 2007 ICRP calculation of effective dose. Twenty-one dosimeter locations were utilized.

X-ray Tube Assembly:

CurveBeam utilizes an X-ray Tube, model SXR 130-20-0.5, from Superior X-ray Tube Co, 1220 Claussen Drive, Woodstock, IL 60098. Below are the X-ray Tube Specifications:

Superior X-ray Data for the SXR 130-20-0.5:

SXR 130-20-0.5

The SXR 130-20-0.5 insert is a stationary anode, glass envelope x-ray tube. The SXR 130-20-0.5 is an x-ray tube originally designed for use in dental CBCT* applications. The insert should be housed in a unit that allows for insulating media such as high dielectric mineral oil (Diala-AX) or high dielectric pressurized gas such as SF₆ (Sulfur Hexafluoride).

* Cone Beam Computerized Tomography

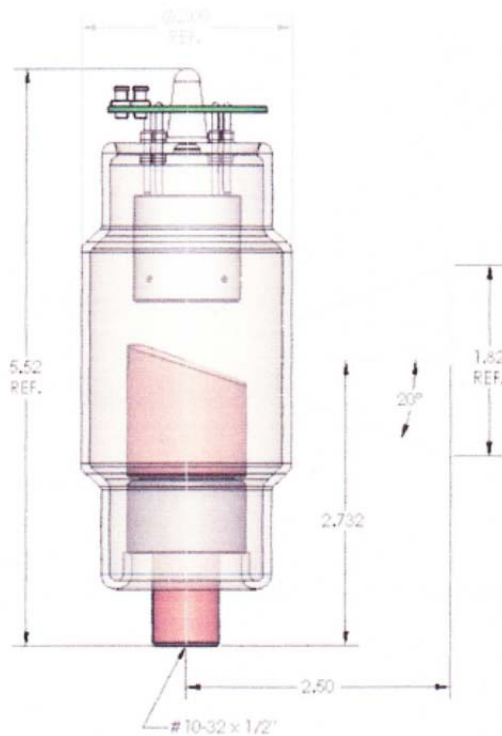

SXR 130-20-0.5 Outline Drawing

Physical Characteristics:

| | |
|----------------------|-------------------------------|
| Glass Frame: | Borosilicate 0.085 thick: |
| Inherent Filtration: | 1.1 mm Al equivalent at 80 kV |
| Focal spot: | 0.5 mm Nominal |
| Target Angle: | 20° |
| Target Material: | Tungsten |
| Filament Material: | Tungsten |
| Focus Cup Material: | Nickel |
| Anode Body: | Copper |

Thermal Characteristics:

| | |
|----------------------------------|-----------------|
| Anode Heat Storage Capacity: | 30 KHU's (21KJ) |
| Max Anode Heat Dissipation Rate: | 17.9 KHU's/min. |
| Duty Cycle: | 1:20 |

Electrical Characteristics:

| | |
|----------------------|-----------|
| Max. Tube Potential: | 130 kV |
| Filament V-A Curve: | See Chart |
| Max. Power: | See Chart |
| Max Single exposure: | See Chart |
| Max. Continuous Exp. | 1.8 mA |

NOTE: * Please contact Superior Engineering Department for cathode terminations options.

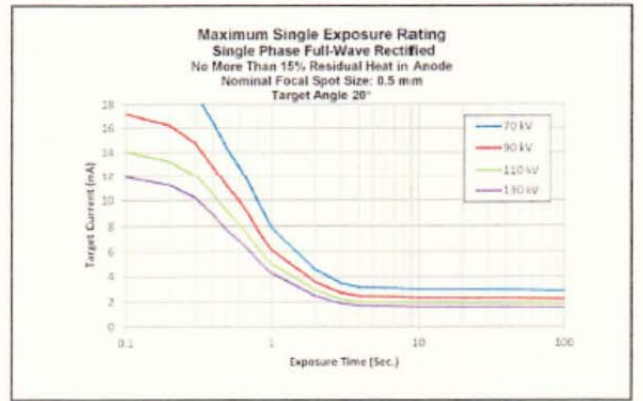
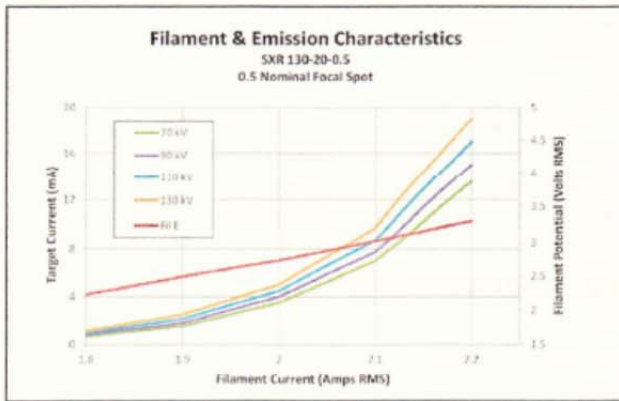
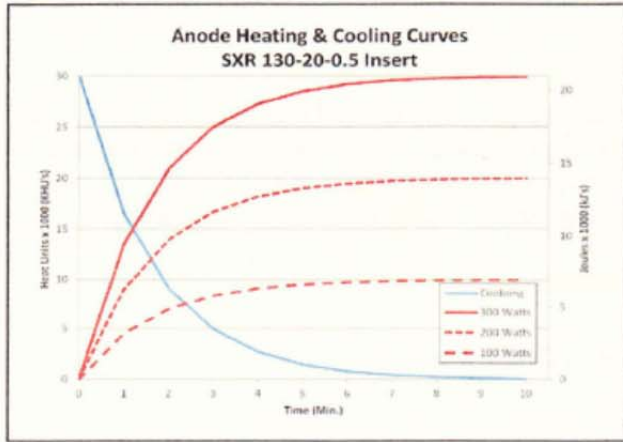

Beam Path and Angulation:

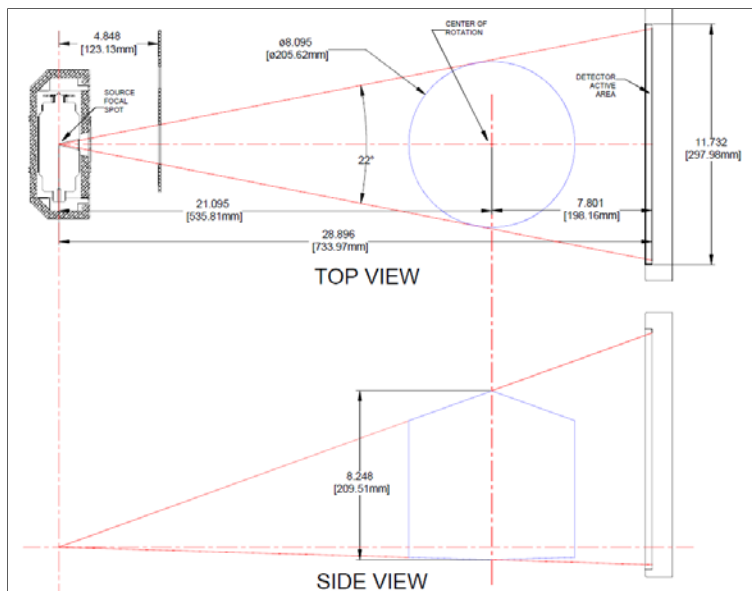

CHAPTER 6: Operations - Acquiring a Scan

ACQUIRING A SCAN

System Startup:

The PedCAT system at a minimum includes the Scanning device, the computer server, and an Operator's control Terminal. All must be powered **ON** in order for the system to operate properly.

The Scanning device circuit breaker should always be set to the ON position. This is located in the back of the machine. This is the machine ON/OFF control. The vertical line is the ON position. The 0 is the OFF position. The image below shows the scanner in the ON position:



Power ON is indicated on both the Machine Status Indicator panel and the Operators control box Status indicator panel lights. Power ON is lit in **Green**. **The machine must be ON for 30 seconds before the Acquisition Software should be launched. Optimal Scanning results will be achieved with the machine warmed up for 2 hours.**

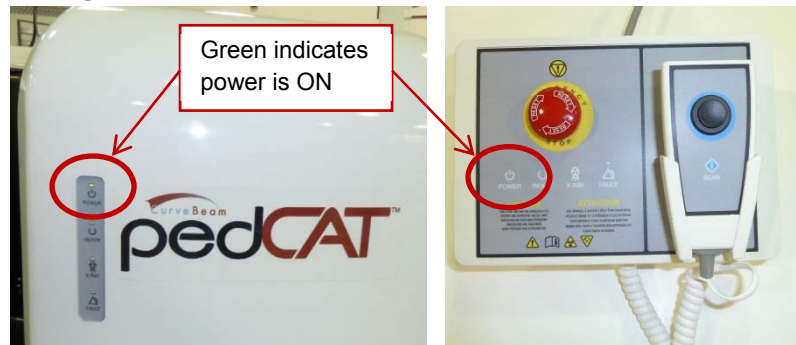

The scanning software is accessed via the Quality Control Workstation (QCW) and can be viewed on the DELL tower as well.

Start up the Acquisition software by double clicking on the CB-Scanner Shortcut



An “About Screen” will appear which displays the software version number and details. Or, the following About screen can always be accessed from the Acquisition software’s “About” button.

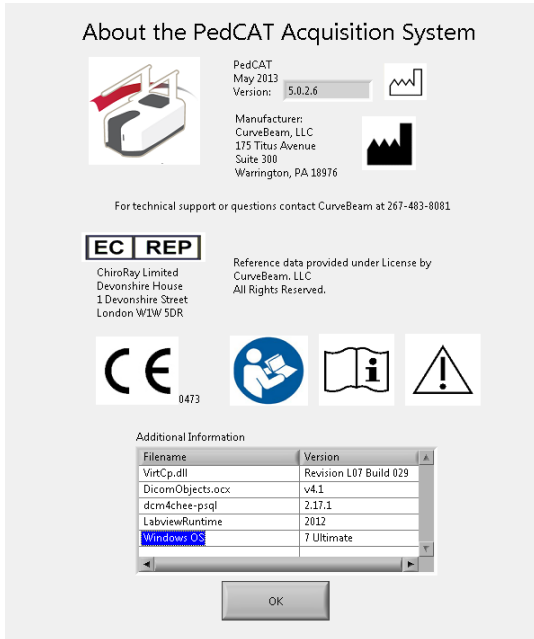

Once the acquisition software is launched, a system “Startup” window (also referred to as the “Initialization” window) will display indicating if various parts of the system are functioning properly or not. When the row has two dark buttons, that item is still awaiting a status and will eventually change the color from either the dark green to bright green or from dark red to bright red. The bright red buttons can indicate the functionality is still undergoing the startup test, so until it has successfully passed this testing, it will be illuminated bright red.

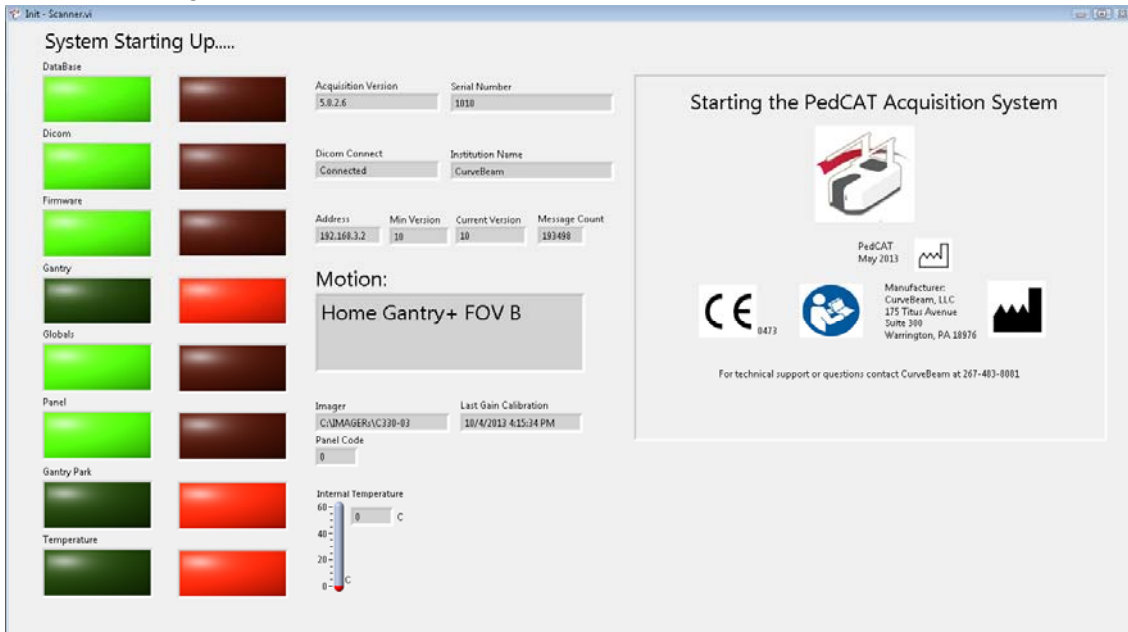

If one of more of these functions illuminates bright red, and remains bright red, it indicates a failure, please contact CurveBeam Technical Support if a light REMAINS on as follows:

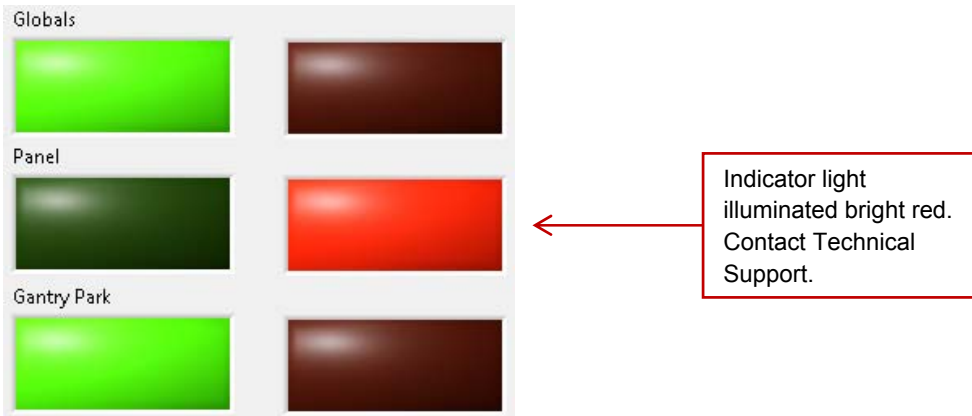

All Startup lights should be illuminated bright green once diagnostics have been completed successfully. If Startup was successful, the Startup window will close on its own, and the software will automatically display the Patient Worklist Window. The following depicts a successful Startup with all lights illuminated bright green:

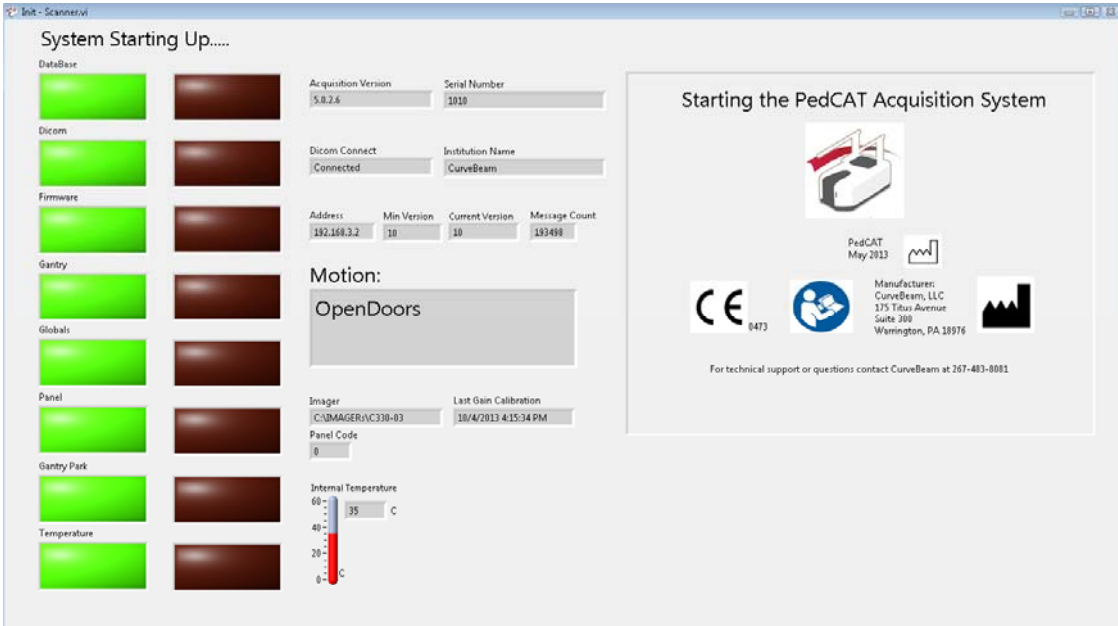

PedCAT Acquisition Software Interface:

The PedCAT Acquisition Software, “CB Scanning Device” Interface consists of the below sections, each with its own tab near the top of the screen:

- Patient List: Access or Add New patient information and intended procedure.
- Procedure: Perform the Scan Acquisition.
- Quality: Perform a QA (Quality Assurance) check of the scan acquired.

PATIENT LIST: Accessing/Entering Patient Information & Selecting Scan Procedure:

Patient Demographic Information can be either imported into the system via a Worklist or can be Added as a “New Patient” via the PedCAT ACQ software Patient Tab when “Add Patient” is selected.

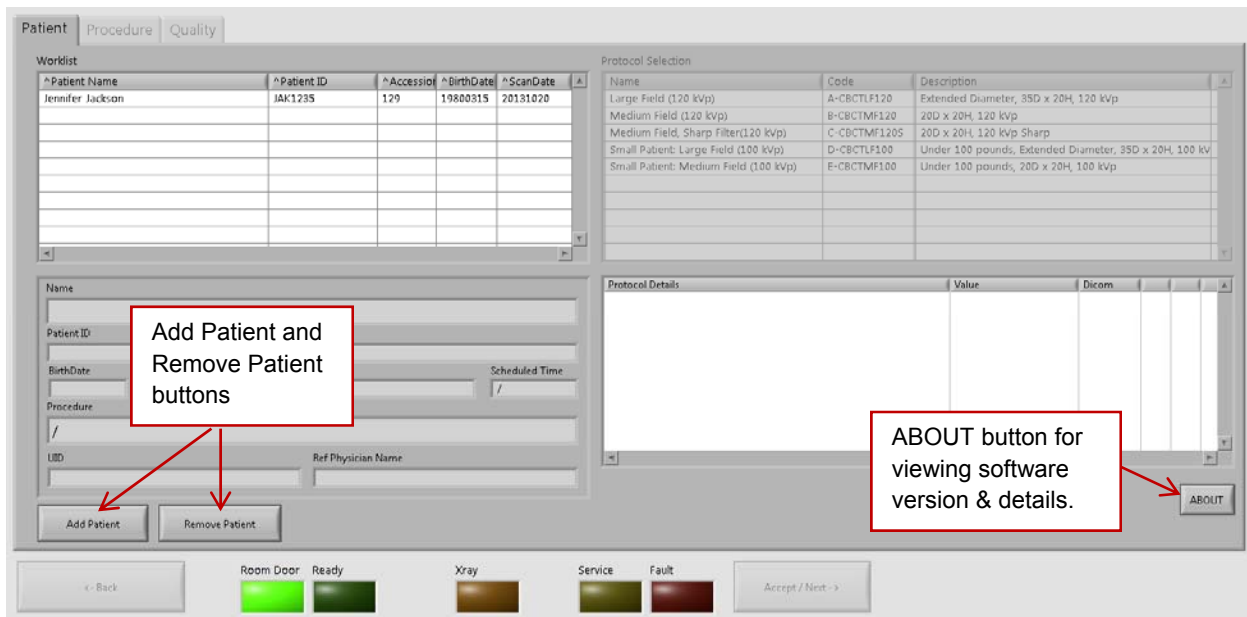

To add a patient’s scan to the Worklist, select the “Add Patient” button at the bottom of the screen. If a procedure is added by mistake or needs to be removed, highlight the entry in the worklist and select the “Remove Patient” button at the bottom and the patients scan will be removed from the list.

When the “Add Patient” button is selected, the following pop up box will appear:

| Procedure | Code | Description |
|----------------------------------|---------|-------------|
| CT LE LEFT WITHOUT CONTRAST | CTLELWO | |
| CT LE LEFT WITH CONTRAST | CTLELW | |
| CT LE RIGHT WITHOUT CONTRAST | CTLERWO | |
| CT LE RIGHT WITH CONTRAST | CTLERW | |
| CT LE BILATERAL WITHOUT CONTRAST | CTLEBWO | |
| CT LE BILATERAL WITH CONTRAST | CTLEBW | |
| CT FOLLOWUP | CTFU | |

On the Add Patient Procedure window, the minimal patient information that **MUST** be entered is **Patient ID, Patient Name and Procedure To Add. The ID# MUST be unique to this patient.** The other items are optional. The Accession Number field can be manually entered, or if left blank one will be auto generated. After all the required fields are entered and any optional fields as well, select the “OK” button under “Add” to add the patient to the Worklist.

To select the patient for the scan, highlight on the patient's line in the Worklist. The patient's information that was entered will appear under the worklist. Select a protocol from the right side of the screen, under Protocol Selection, for the list provided. The details of the protocols are listed below the Protocol Selections, as each one is selected. Once the patient and protocol have been selected, click on "Accept/Next" to move to the Procedure tab. The "Accept/Next" button is remain grayed out until the patient and protocol have both been selected.

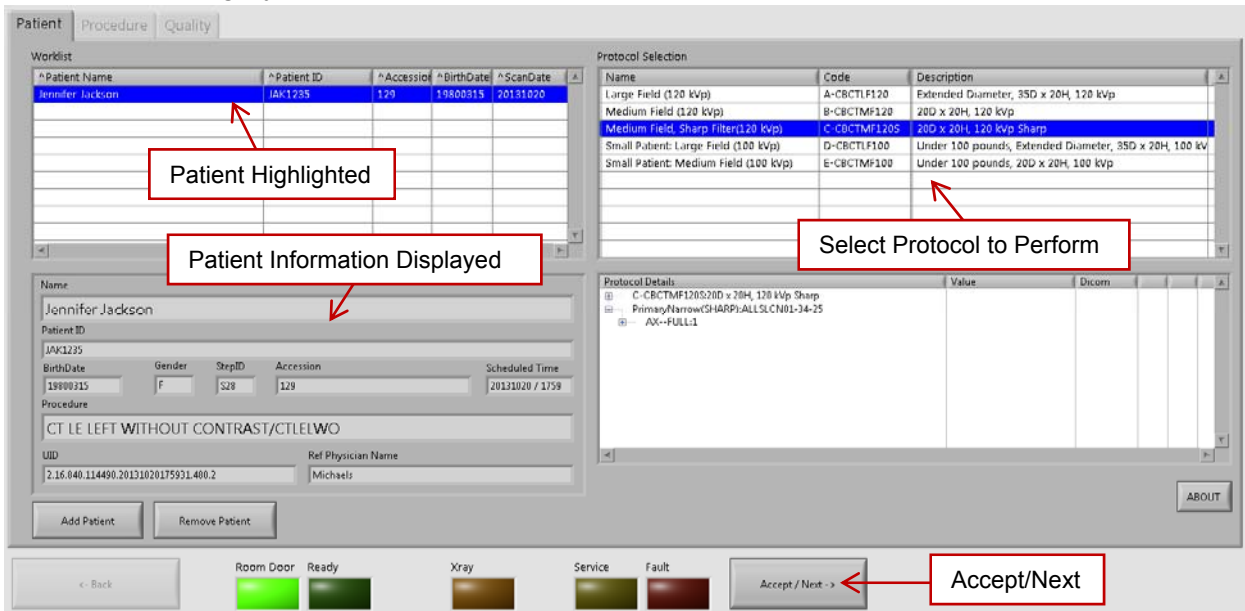

Patient Size for Protocols :

Patient size has been separated into 2 categories

- Small size (this will use exposure factors of 100 kVp, 5 mA).
- Normal to Large size (this will use exposure factors of 120 kVp, 5 mA).

Small is defined as patients weighing 100 pounds (45 kg) or less, with a minimum weight of 50 pounds (23 kg) and groin area at least 22" (56 cm) above the floor.

Normal to Large is the remaining population which is defined as 101 – 400 pounds (46 – 181 kg) and groin area at least 22" (56 cm) above the floor.

RECOMMENDATIONS for Selecting a Protocol:

There are 5 Protocols to select from:

Medium Field (120kVp): (20 cm diameter x 20 cm height, 0.3 voxel):

Select this option if the patient size is normal-large as defined above, and if you need to capture only one foot or a partial area of interest for one foot.

Medium Field, Sharp Filter (120kVp): (20 cm diameter x 20 cm height, 0.3 voxel):

Select this option if the patient size is normal-large as defined above, and if you need to capture only one foot or a partial area of interest for one foot, but specifically for visualizing anticipated small fractures or stress fractures.

Large Field (120kVp): (35 cm diameter x 20 cm height, 0.37 voxel):

Select this option if the patient size is normal-large as defined above, and if you need to capture both feet in a scan. This procedure automatically executes 2 rotations around the patient so it is longer than the single foot procedure.

Small patient: Medium Field (100kVp): (20 cm diameter x 20 cm height, 0.3 voxel):

Select this option if the patient size is small as defined above, and if you need to capture only one foot or a partial area of interest for one foot.

Small patient: Large Field (100kVp): (35 cm diameter x 20 cm height, 0.37 voxel):

Select this option if the patient size is small as defined above, and if you need to capture both feet in the scan. This protocol automatically executes 2 rotations around the patient so it is longer than the single foot procedure.



WARNING The patient must wear a protective full wrap X-ray shielding apron (lead apron) during a scan. Patients less than 21 years old, small size patients (under 100 pounds) and children must also wear a gonad and ovarian front and back protective shield.

Once the Protocol is highlighted, the “Accept/Next” button will become non-gray. Click “Accept/Next” when the protocol is correct for the patient being scanned to continue with the Acquisition process.

PROCEDURE: Performing the Acquisition:

The Acquisition will be performed via the “Procedure” Tab. The Procedure Tab will display the current selected Patient Name and Procedure, as well as User Instructions and Information as to the status of what the software and scanner are doing.

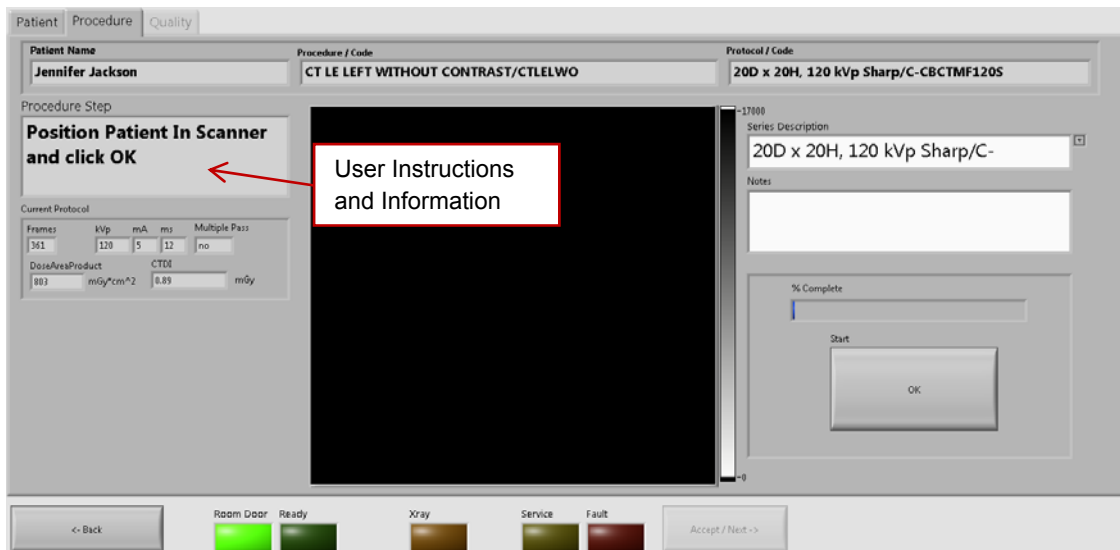

Follow the instructions as stated in the Procedure Step box.

Additionally if an alternate Series Description is desired, select from the pulldown list, or use the blank entry to provide a different Series Description.

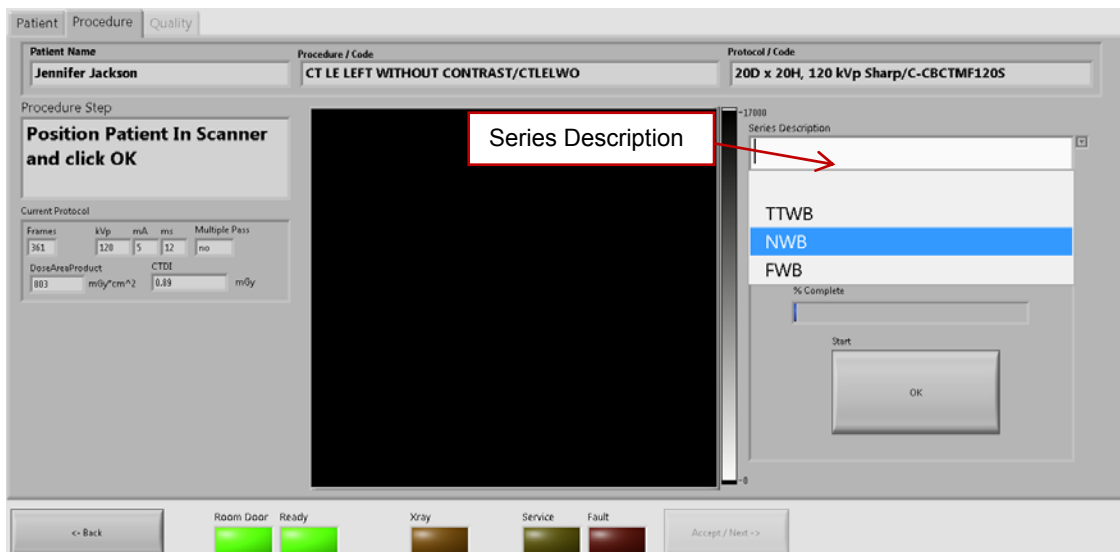

If any notes need to be added to go along with the current scan, they can be added in the Notes Field as shown below:

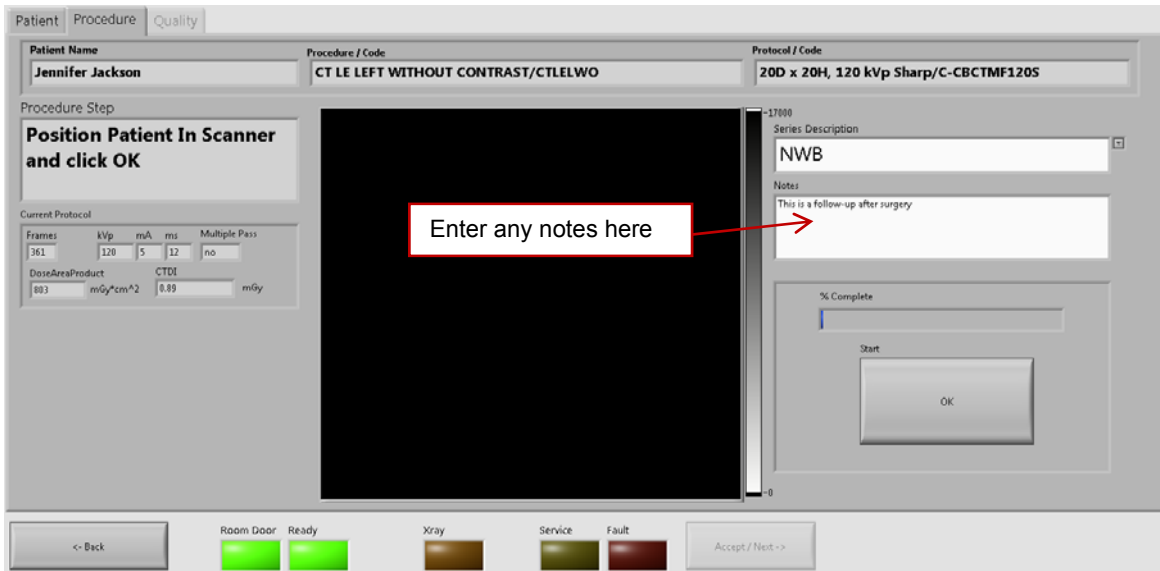

Patient Positioning:

Before positioning the patient in the machine, remove his/her shoes/socks. We recommend the patient not step bare foot on the patient platform. Proper foot protection should be provided.

Have the patient put on FDA approved medical gloves and foot protection as recommended in Ch. 3 Safety Items, Patient Preparation Recommendations section.

Drape the patient with protective shielding for the procedure as recommended in Ch. 3 Safety Items, Radiation Safety section.

The patient will now need to be positioned in the machine. The Door Gates to the machine should now be in OPEN position in order for the patient to step in.

*Be sure to position your patient before clicking the OK button. Once the OK button is clicked, the Door gates will CLOSE.

Door Gates Open

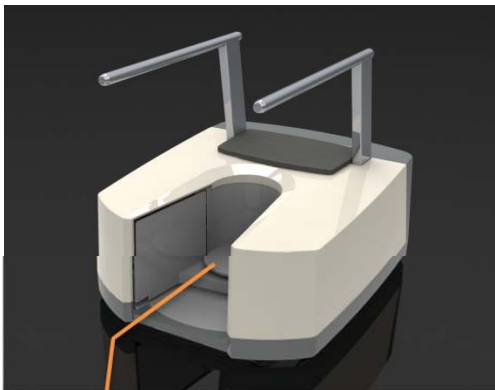

Patient Platform for Standing during a procedure

Door Gates Closed

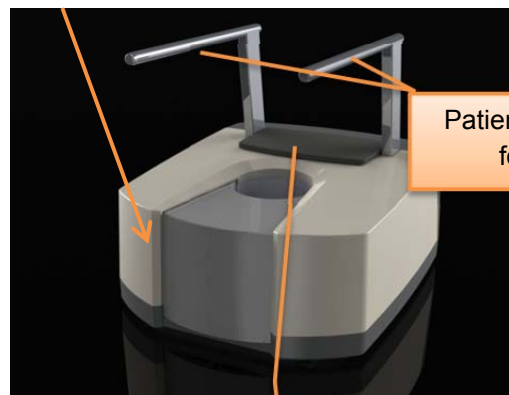

Patient Handle Bars for support

Patient Seat for Sitting during a procedure

The patient should be instructed to step into the machine and position the feet on the platform. Also instruct the patient to use the handle bars for support as they step into the platform.

There are 2 standard positions for imaging the patient.

- Standing: for weight bearing images.

If Standing, the patient should step onto the platform and continue facing in the step in direction. However, the patient could also turn around and face outward if necessary. We recommend standing facing outward as it provides more clearance for the doors to close and is best for the patient to look at the operator for instructions.

Use the circular guides on the platform for feet position as described in the next section.

✔ Note: Please remind the patient to stand in the appropriate weight bearing position and use the handle bars for stability during the scan. The handle bars are meant for support only.



- Sitting: if the patient cannot achieve standing position or if standing is not required.

If Seated, the patient should step onto the platform, turn around and face the doors and then sit on the padded seat on the machine. Use the circular guides on the platform for feet position as described in the next section.



Circular Positioning Guides:

These guides on the patient platform are intended to assist the operator in positioning the patient's feet/foot into the field of view.

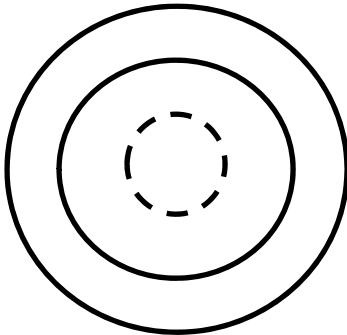

The most outer circle is for the Full, both feet procedure option (35 cm diameter). This is for a scan that needs to include both feet. Both feet should be positioned within this circle in order to capture both.

Positioning Illustrations are intended for Training purposes only.



Sample Results of Full both feet Field of View



The second circle is for the Partial Single Scan option (20 cm diameter). This is for capturing one foot or a partial scan of one foot only. The area of interest for the scan should be positioned within this circle in order to capture it. So if you require the forefoot, then ensure that it is within the inner circle, however the hindfoot may not fit and would not be included in the scan (and vice versa). Smaller foot sizes may capture from Fore to Hindfoot.

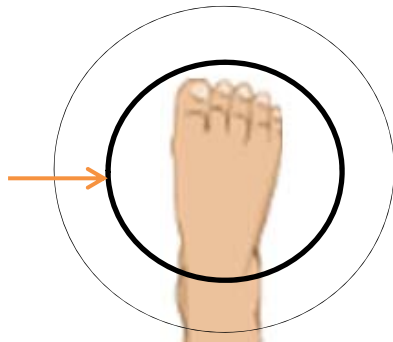

Sample Results of Partial Single Foot Diameter Scan
Field of View, Forefoot

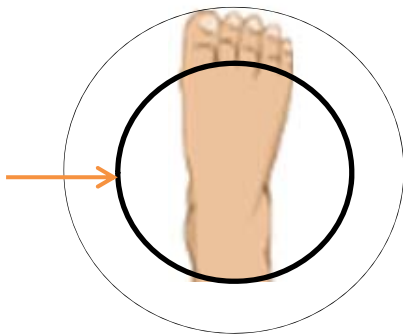
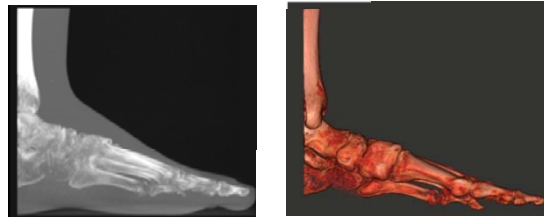

Sample Results of Partial Single Foot Diameter Scan
Field of View, Hindfoot

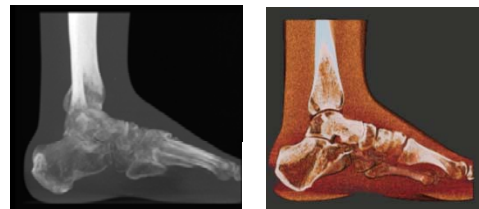

Alignment Light Positioning Guides:

There are 3 laser alignment lights to also assist the user in positioning the patient if needed. Access to turning these lights ON are on the upper corner of the left Door. When this button is pushed, the 3 lights will illuminate until the button is released.

One is a vertical light in the very center of rotation (center of the circles). The anatomy that this light falls on will be in the very center of the scan.

The other two lights are horizontal, one at the top of the scan (20 cm height), the other at the center of the scan (10 cm height).

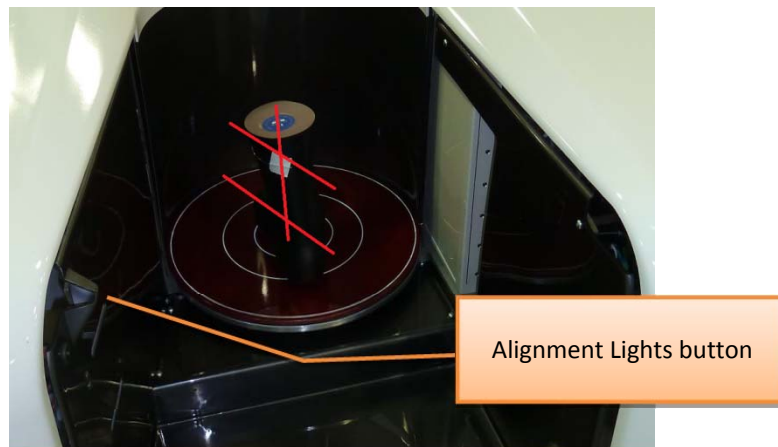

⚠ WARNING Laser beams can cause optical damage. The operator should avoid looking directly into the beams. The operator should instruct the patient to avoid looking directly into the beams. The use of optical instruments such as eyeglasses with large diopter or mirrors, increase eye hazard with this product.

Patient Instructions for a Scan:

Once the patient is properly positioned in the system, the operator should instruct the patient to **hold perfectly still for the duration of the scan**. It is very important for the patient to hold still. If the patient moves during the volume scans, the results may not be optimal. Data is being captured when the alarm is audible (and x-ray light is ON).

- Next, click the OK button in the “Procedure” Tab in order for the Doors to close. Be mindful that the doors closing can result in a pinch point. Instruct the patient to be aware of this and keep all possible interferences clear.

⚠️ WARNING Closing of the Gate doors creates a pinch point. Keep hands and feet clear when closing Gate

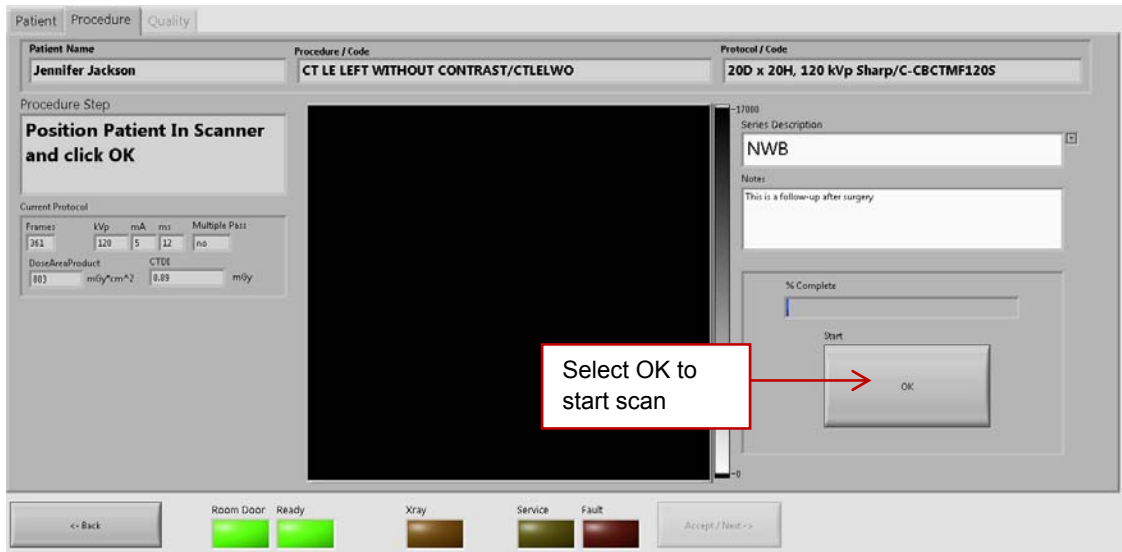

- Next, a message will appear on screen instructing the operator to: “Press and HOLD Scan button”.

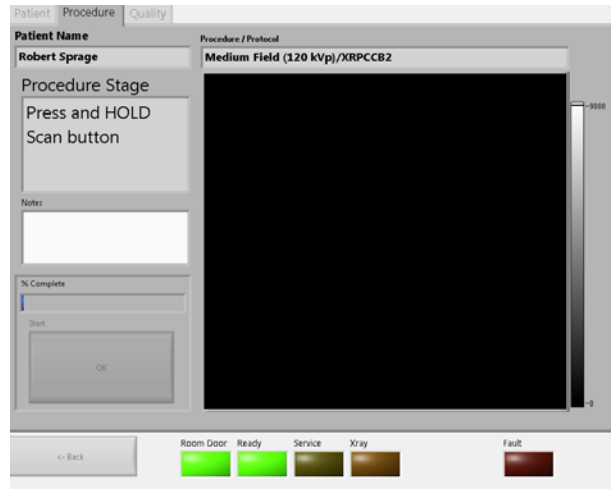

⚠️ WARNING The X-ray device may be dangerous to the Patient and Operator if you do not observe and follow operating instructions. Do not operate this system unless you have received training to perform a procedure.

The Scan Button to start the exposure is mounted on the Operator control box.

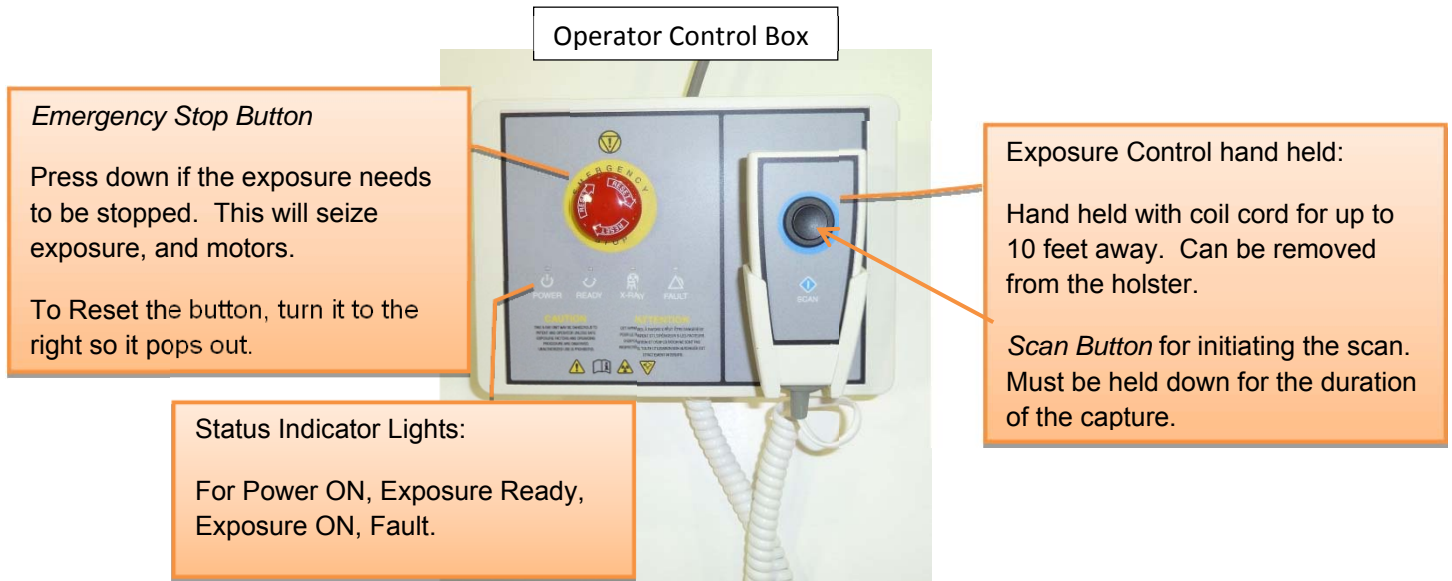

3. Deliver the Patient Scan Instructions to the patient.
4. Now Push & Hold the scan button down. During exposure an audible signal is generated by the machine, and the visual X-ray ON indicator lights will be illuminated in Amber color. The visual X-ray ON indicators are on the machine, the operator control box (above) and in PedCAT Acquisition "CB Scanning Device" software. The Operator should hold the exposure switch for the duration of the exposure as indicated by sound and lights.

Software

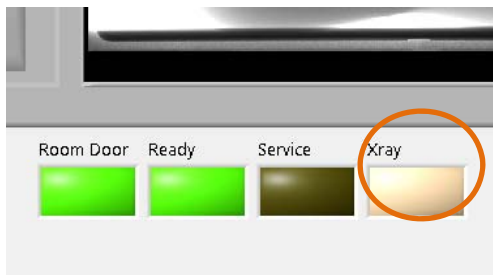

Machine



- When the audible buzzer and “X-ray on” light turn off, it is OK to release the exposure switch.

NOTE: If you release the exposure switch before the exposure time has completed, the system will STOP exposing, however the gantry and motors will complete their sequence. If the button is released prematurely, the buzzer and indicator lights will turn off and the Error message below will display on screen:

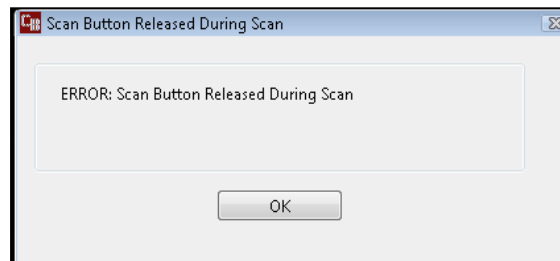

Emergency Stop: In the event of an emergency during a procedure (any moving component collides with any parts of the equipment or items in the environment, or that could cause physical injury to the Patient), the Operator or Patient should utilize one of the 2 the designated Emergency Stop buttons to turn off the power to the X-ray and all moving parts in order for the Patient to be safely removed from the machine. There is an Operator E-stop button on the Operator Control Box and there is a Patient E-Stop button on the machine by the seat. The Emergency Stop(s) when activated will remove ALL power from the machine. If the machine gates are closed, they will have to be opened manually and any obstructions to the patient exit will need to be manually removed before the patient is safely removed from the machine.



- If performing a Large Field scan, the gantry will need to rotate around the patient twice. While the gantry repositions itself, the x-ray will not be fired and the scan button can be released. It is however critical that you inform the patient to not move and await the second pass with the x-ray. When the gantry is in position again, there will be a user prompt again to Press and HOLD the Scan button.

7. Once the capture is complete, the Door Gates will automatically OPEN. The patient can now safely EXIT the machine. If the scan is a Large Field of View scan, the machine will fire x-ray, reset itself, then fire again. The door will not open until all of the x-ray is completed.
 - If the patient is Standing, he/she should turn around while still on the platform, using the handle bars for support and step forward out of the machine.
 - If the patient is Sitting, instruct the patient to carefully stand and use the handle bars for support while stepping forward out of the machine.
8. When the Accept/Next button becomes visible, click on it.

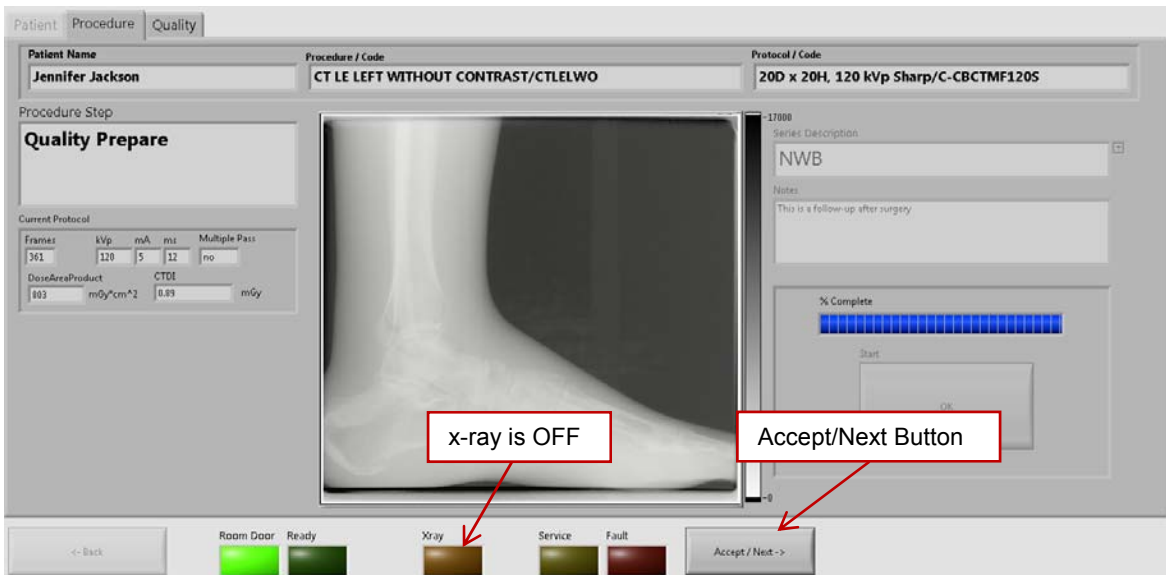

9. Once on the Quality screen, wait for all of the QA images to be present. Initially the QA screen will appear as in the following image.

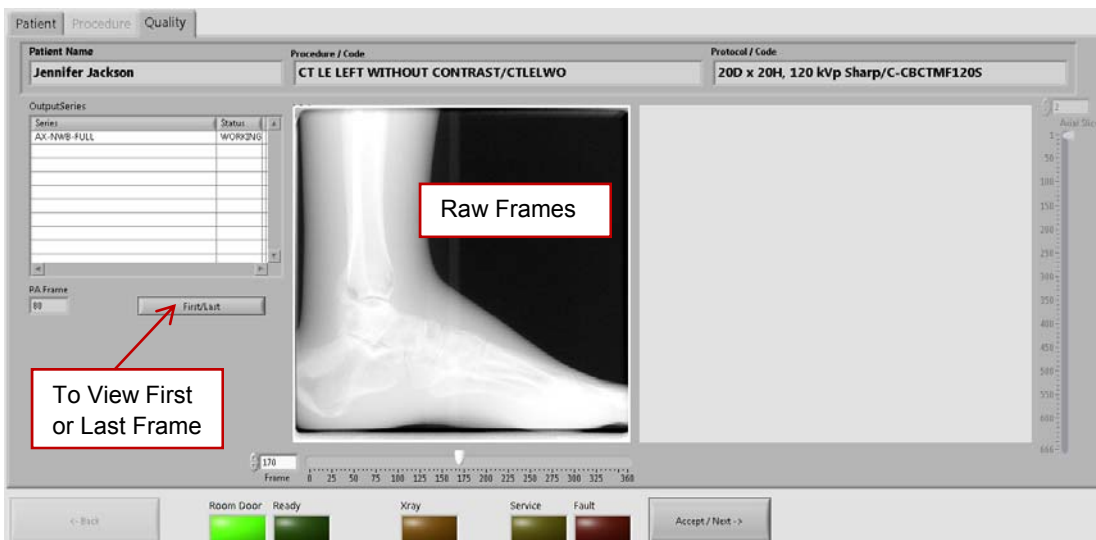

10. While waiting for the image to finish processing, check for movement of the patient during the scan, compare the first and last frames by using the “First/Last” button. View all images as they were acquired by using the slider below the raw frames or typing in a number to directly view that single frame.
11. Once the processing is completed, the right side of the screen will display the Axial slices. Scroll through them using the slider bar to the right of them.



12. Once certain the image looks like the anatomy desired was done so acceptably, click on the Accept/Next button.

✔ NOTE: If there is any indication of vibration to the system, or malfunction to the system, or computer crash during a scan, please contact CurveBeam Technical Support for assistance. If there is a failed procedure, turn the machine off by the Emergency Stop button, following the below procedure.

Procedure for Emergency Removal of a Patient:

The system has undergone extensive testing of the mechanically, electrically and software performance, but if an unexpected occurrence is observed and/or the software locks up during a scan or an emergency arises where it becomes necessary to interrupt a scan and/or remove a patient from the system before a scan is completed, please follow these steps:

1. Press the EMERGENCY STOP button. This will halt the X-ray as well as the motors to the machine functions and all power to the machine. The message below will display on screen and will terminate the “CB Scanning Device” Acquisition software:



2. Open the Gate doors manually with your hands by using the slots at the top of each door to grasp and slide to an open position. Manually push the gantry out of the way if necessary.
3. Carefully assist the patient to step out of the scan platform area.
4. Reset the machine: Close the PedCAT Acquisition, “CB Scanning Device” software (if not already). Release the E-stop that was engaged by pressing in and turning the knob to the right until it pops up. Then turn the machine power back ON at the Main Circuit Breaker. Wait 2 minutes, then re-launch the PedCAT Acquisition “CB Scanning Device” software. Now the system can be operated again as expected

CHAPTER 7: Using the Viewing Software: CubeVue

Now that the data is acquired, it can be reviewed and post processed within the viewing software, CubeVue.

CubeVue can be accessed by the Viewing Terminal, MD workstation, or any computer that is connected to the PedCAT server via the facility network and has CubeVue software installed. Log into the Viewing Terminal, MD Workstation computer or any other workstation.



Then, to launch CubeVue, click on the CubeVue icon. The “About” Screen will appear showing software version & details. This can also be accessed by selecting *Settings/About*.

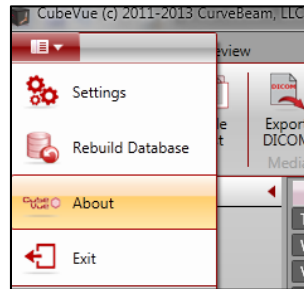

The CubeVue software has the following components to it:

- Patient List: for accessing, importing & exporting patient datasets.
- Review: for reviewing and processing the patient datasets.

PATIENT LIST:

When CubeVue is launched, the “Patient List” will display the list of patients with their datasets for the user to load. The volume datasets will display as Raw or Reconstructed. The Raw data sets are listed with the description of “RAW”, the Reconstructed data sets are listed with the description being the protocol for which the scan was acquired.

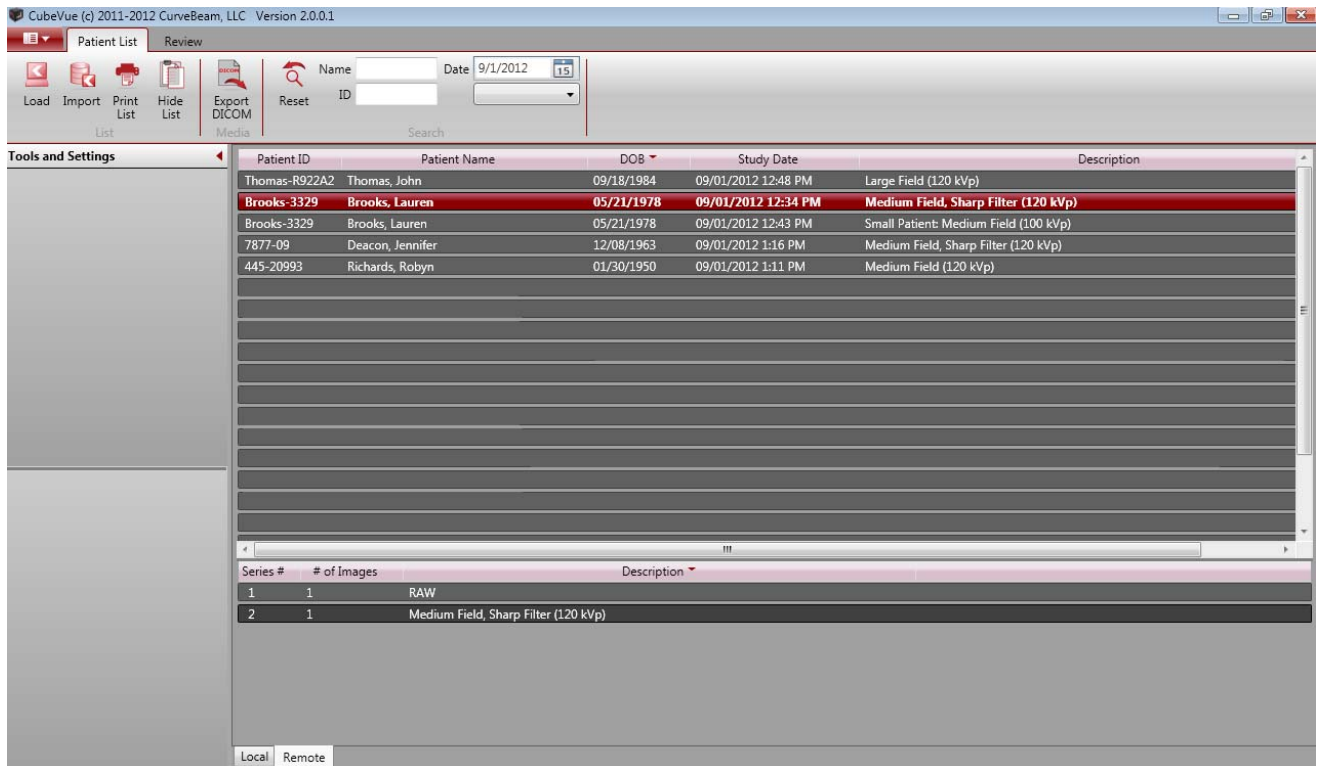

After selecting the patient name from the list at the top, then select which type of scan to view. Typically the Reconstructed study will be the type of scan to select. Once the scan is selected, the Review Tab will be active.

If the patient that needs to be viewed does not exist in the patient list, it can be imported from an external location. The scan must have been taken using a PedCAT scanner in order to import

the patient scan. To Import a study from a PedCAT, select the Import Icon:



Once selected, a prompt will appear asking for DICOM Study or Raw File. DICOM Study would be the option to choose to navigate to the location of the study to import.

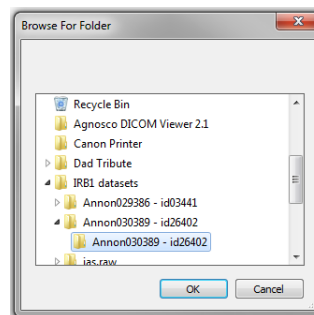
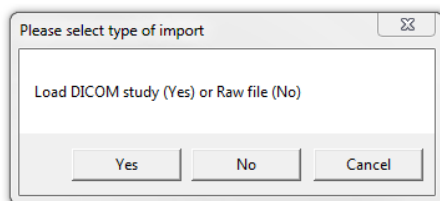

An Imported Study will reside in the “Local” Tab.

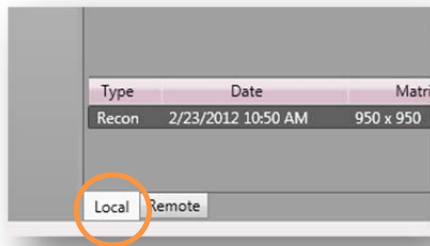

CubeVue allows for the user to have more than one scan loaded at the same time. This can be useful when comparing two scans done on the same person, a progression or a before and after type scenario. This is accomplished by first loading up a single scan. Then, from the Patient List tab (at the top), click first on “Load into 2nd work space” and then select the second series (scan) to open from the patient list.

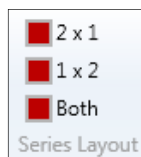
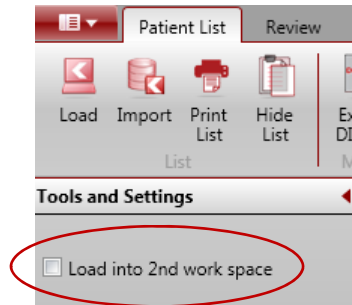

Using the Series Layout tools: the user can select which way to view the images, either both of the scans in a vertical mode (select 2x1) or a horizontal mode (select 1x2). The limit to the number of scans that can be opened at once is just two scans. To remove the scan and load a different second scan, close the series to be unloaded and then return to the Patient List. Repeat the steps above to load a different series into the 2nd workspace.

Conversely, if the patient’s DICOM data needs to be sent to another location, the user can



Export the DICOM data. To do this, select the Export DICOM icon:

Once selected, the user can Browse and select the location to export the DICOM data.

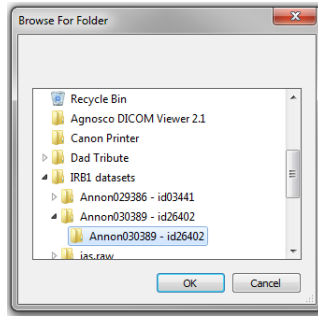

To put the study on a CD, have a CD in the drive and then navigate to the CD drive as the destination folder for the Export DICOM. This will then place the DICOM data on the CD using the Windows Burning Software program.



To print the patient list, select the icon:

There is a button that will allow the user to hide and unhide the Patient List. To do this, select the icon:

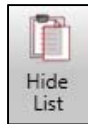

After 10 minutes of inactivity, the Patient List will be hidden for privacy purposes. In either case, when the list is purposely hidden or hidden after the 10 minutes, to unhide the Patient List, click on the Hide List icon to unhide the list.

It is possible to view only a subset of the entire Patient List. This can be helpful when a portion of their name or ID is known, or when trying to locate a patient that was scanned today, on a known date, or within the last few days.

To locate a patient in the list using a partial (or full) name or ID, start to type in the “Name” or “ID” fields. As information is typed in, the Patient List will start to decrease as only the patients that match the criteria entered are displayed. To do this, select the pulldown shown below to select a number of days since the scan was acquired.

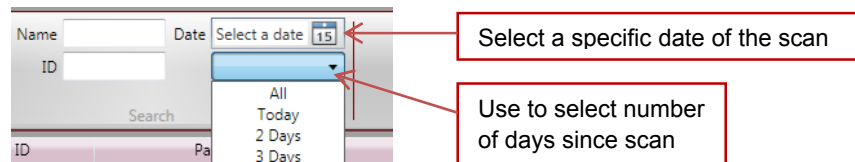

Additionally, typing in a partial name or partial ID will display all the scans listed with the matching Name or ID as a part of the patient’s information. Or, a specific date can be selected

and all scans acquired on that date will be displayed. To select a specific date, click on the calendar next to "Select a date" in the image above.

REVIEW TAB:

Once the patient scan is selected from the Patient List, the scan will open in the Review Tab.

The Review Tab consists of 4 different Screens for viewing and processing data and a Main Menu Bar. The Tabs along the bottom are:

Combined 3D/MPR: contains a 3D rendering of the scan plus multiplanar reconstructed slices.

3D: contains the 3D rendering of the scan only.

MPR: contains the multiplanar reconstructed slices only.

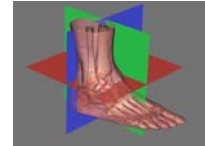

Each "Plane" is color coded with Red, Green or Blue.

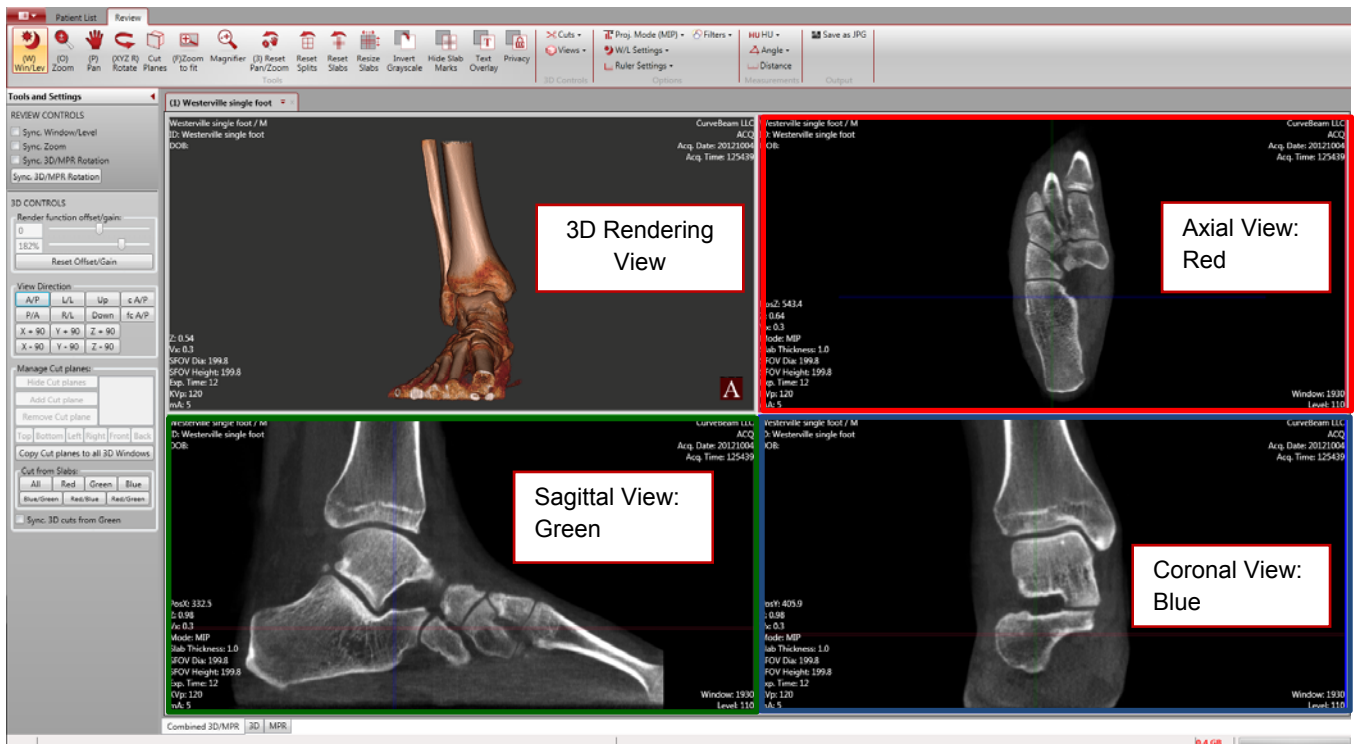

3 Review Tab Options

The Review Main Menu Bar (Ribbon):

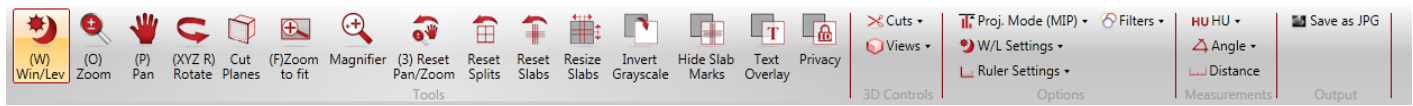

Review Tab layouts.

MPR stands for Multiplanar Reconstruction. There are 3 views that are associated with MPR images. These views hold true for both the Combined 3D/MPR and the MPR Tabs: Axial, Coronal, Sagittal. Utilize the colored Slice Indicator Lines to know the slice locations.

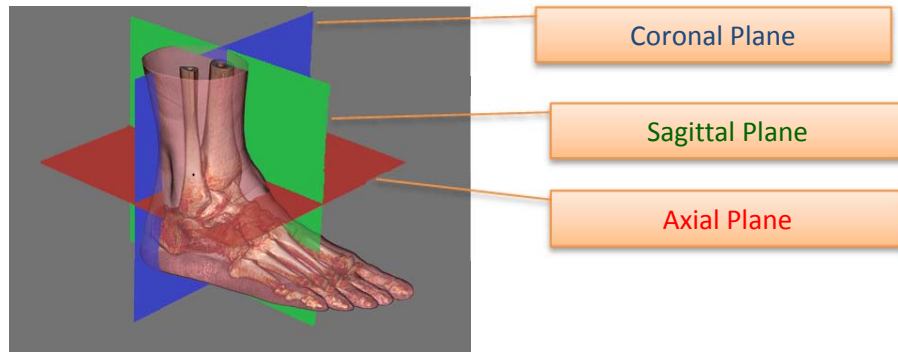

- **Axial:** slices through the anatomy from top to bottom, bottom to top: **Red** plane. The “orientation of the image” is as if you were looking down on your foot/feet.
- **Coronal:** slices through the anatomy from back to front, front to back. **Blue** plane. The “orientation of the image” is as if you are looking at the foot/feet from behind.
- **Sagittal:** lateral slices through the anatomy. **Green** plane.

Scrolling through cross section images in the MPR views:

The scrolling cursor is the Default cursor.  To scroll through slices, hover the mouse cursor over a desired view and this cursor should be enabled. **Left Click, hold and drag to scroll through slices.**

Alternately, each colored line in a Window can be clicked and dragged to scroll through its corresponding colored views.

The red line that cuts through two images, the Coronal and Sagittal, is the reference point for the Axial slice that is shown in the red outlined box. Moving the red line in either the Coronal or Sagittal views will change the slice location and the image displayed in the Axial view. The red reference markers will always depict the location of the Axial slice. This reference is the same for both the Coronal and Sagittal views as well, with the Coronal in green and the Sagittal in blue.



Alternately, for scrolling through slices in fine increments, when the cursor is hovered over an MPR image, use the mouse wheel to scroll through slices.



Each Tab has use of Universal Image Processing and Planning Tools:

Slab/Slice Thickness:

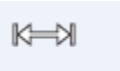

There are 2 methods to enable the tool for changing the thickness of the anatomy viewed, Hold down the SHIFT key and click on any of the colored reference lines and then drag the mouse to change the width of the line to represent either a larger or smaller slice of anatomy.

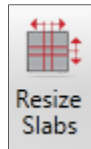
The cursor should change to this:  for horizontal lines or  for vertical lines.

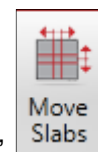
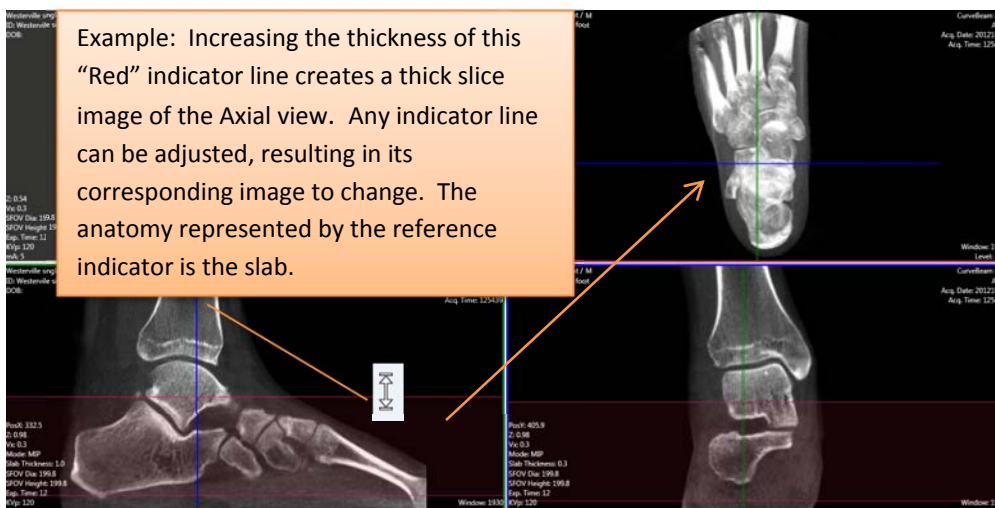

OR, click on the “Resize Slabs” button on the Main Menu Bar. This will change the cursor for resizing. To disable the resize, click on the icon a second time and the cursor will change back to normal.



To move a Slab to a new location, click the now toggled “Move Slabs” button on the Main Menu Bar and the cursor will change to its default   which will allow you to “move” the slab to a new location by dragging the slab.



To Reset the Slabs back to normal thin slices, click the “Reset Slab” button on the Main Menu Bar. If selected, a warning message will appear to verify that the slabs do need to be reset. The message will appear as shown below:

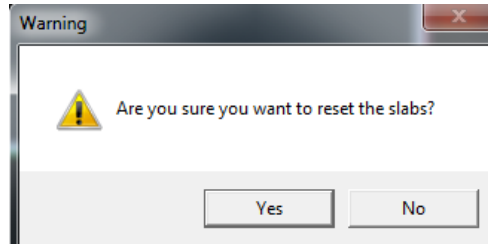

Image Enhancement Tools: These are functions that can be used to enhance and manipulate the image for optimal viewing.



Window / Level (Brightness / Contrast):

To adjust the Window/Level, select the Win/Lev icon and then selecting a window to make the window/level change to. Changes are made by first clicking in the window, then moving the mouse up and down and then left and right until the optimal window/level is achieved. To deselect the Window/Level function, click on the Win/Lev icon a second time.



Zoom:

If the image does not appear as close as desired, then select the Zoom icon and select a window to change the zoom factor on. If you drag your mouse up, the image will zoom in and appear closer. As the mouse is moved down, the image will appear further away. To deselect the Zoom function, click on the Zoom icon a second time.



Pan:

To adjust the image to a different location inside the window, the Pan function can be utilized. To center the section of the image desired in the window, select the Pan icon and then select the window to modify. Click on the image and hold the mouse down, while moving the mouse around and the image will move with the mouse movements. To deselect the Pan function, click on the Pan icon a second time.



Image Magnifier:

The Magnifier icon will provide a magnification of the selected image. When the mouse is moved around the anatomy in the selected image box, the magnification box will be continually updated with the new location of the mouse.

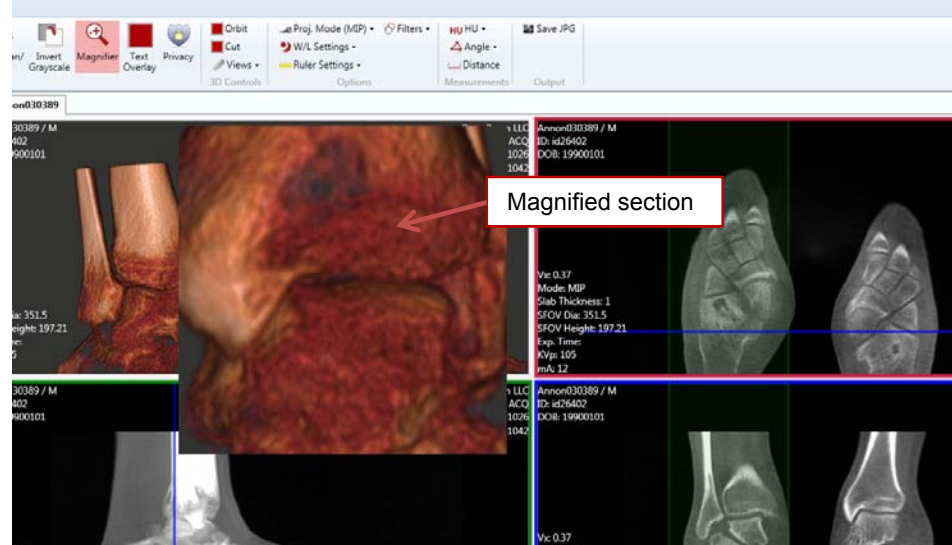

Reset Pan/Zoom:

Once the Pan and Zoom functions have been used and a different section of the anatomy is of importance, then the user can begin the Pan and Zoom process again by selecting the Reset Pan/Zoom icon. When the Reset Pan/Zoom icon is selected, the image will appear as it did when the study was originally first loaded.



Splits / Reset Splits:

The individual windows can also be moved to allow for a larger window for any of the four windows. So that if the user would like to see a full screen of the Axial image, mouse click on the center of the four windows and adjust the window sizes so that the Axial image takes up the majority of the window.



Once done with viewing the Axial window, the window sizes can be reset with the use of the Reset Splits icon. This icon will put the windows back into the configuration they were in when the software scan was freshly opened.

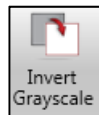

Invert Grayscale:

The Invert Grayscale icon will invert the grayscale on all the images, except the 3D image. Click the Invert Grayscale icon again to revert back to normal grayscale.

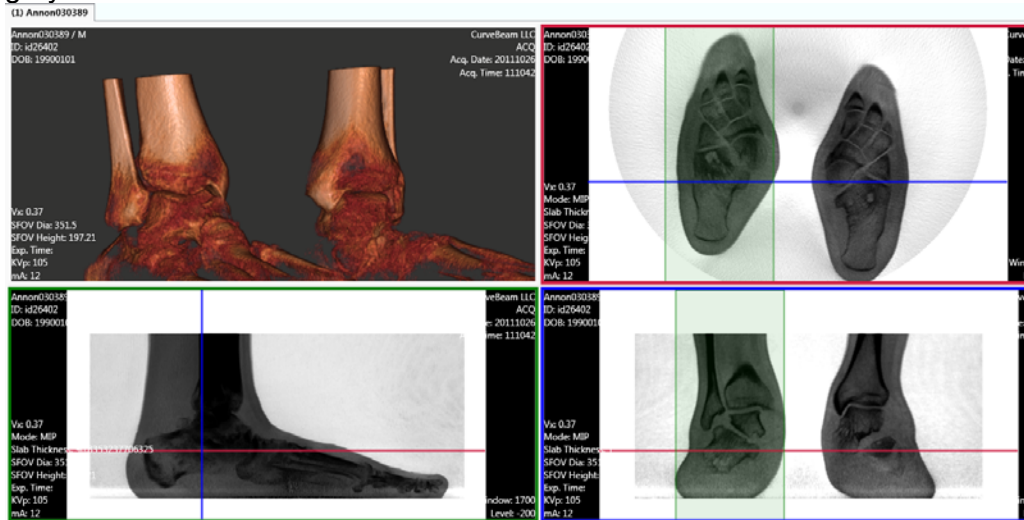

Text Overlay and Privacy:

The overlay on the images is most of the informative text on the image. If the user does not want to display the information, there are two options available. The Privacy icon:



will remove ALL patient information from the image other than Patient ID#. This can be useful if the desire is to maintain a level of anonymity when viewing the scan on the screen. The image should NOT be printed when the Privacy icon is selected and no patient data is displayed. To allow for the basic patient information, then the Text

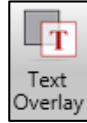

Overlay icon should be selected. This allows the user to display some information but also remove the excess information from the Image Windows.

Projection Mode:

There are 2 options available for projection mode, one is “Radiographic”, the second is “MIP”. Radiographic is the image displayed as a normal radiograph.

MIP stands for Maximum Intensity Projection. This is an image tool that is only useful for thick slice slabs. It will display for each pixel, the most dense valued pixel in the depth of the selected slab, which means it will display the brightest pixel (voxel). Below is a comparison of a thick slice slab as a Radiographic projection vs. an MIP projection.



Radiograph

MIP

To alternate between Radiograph and MIP, click the Proj. Mode icon. It will display to you which mode it is currently toggled to.



Filters:

There are 3 filter options available; Smooth, Normal, Sharp. Filters can be applied to enhance images. The default filter type will be Normal. But if the image requires a little more detail, than the Sharp filter can be selected. Smooth will make the edges of the images appear more smooth, but may lose some detail. Filters are often a personal preference. Select the Filters icon to apply one of the 3 options.

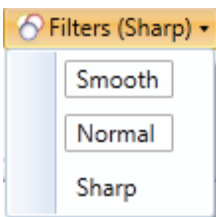

Measurements: There are various measuring tools for treatment planning.

HU: These are for measuring Hounsfield Units, which is density value of an area of interest.

Angle: These are for measuring angles on the anatomy of interest.

Distance: This is for measuring distances in millimeters. There is also a Ruler that can be displayed on the images to assist in quick visual reference of length.

HU Measurements: The HU tool has a drop down with 6 options; rectangle, circle, freehand and line for general use and then QA set Small and QA set Large for doing the QA procedures.

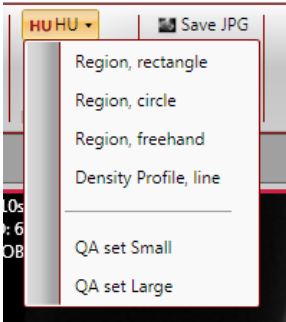

Any of the general use regions can be selected for creating a region of interest (ROI) on the bone in order to obtain a density value reading. For example, if "circle" is selected, a circular ROI can be drawn by point click and drag. Then click a final time to anchor the ROI. The measurement reading will display in the upper right hand corner of the image window. A maximum of 10 measurements can be made in one image window. This tool will remain enabled until disabled by clicking the selection again.

M = Mean, SD = Standard Deviation.



HU Measurement Values

HU Circular ROI

Follow these instructions for the rectangle or freehand as well. The Density Profile line displays in graphical form. Draw a line and the graph will appear.

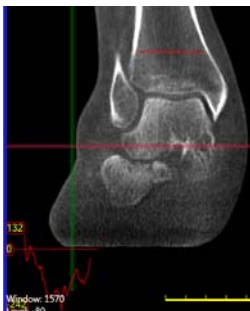

For doing the QA procedures, there are two sets of pre-sized HU regions. Selecting the “QA set Small” will draw small circles that are used to determine the HU of the various materials on the QA Line Pair Phantom. The “QA set Large” will draw large circles that are used to determine the HU of the water.

Angle Measurements:

The angle tool has a drop down with 3 options for measuring angles; Simple, Cobb and Correlate Cobb:

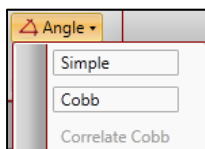

Simple Angle: Select “Simple” to enable the Simple angle tool. The Simple Angle has 3 points of reference. Point, click, move, click, move, click to finish (3 clicks). This will result in an angle in degrees, and the measurement will display in the upper right hand corner of the window. A maximum of 4 measurements can be made in one image window. This tool will remain enabled until disabled by clicking the selection again.

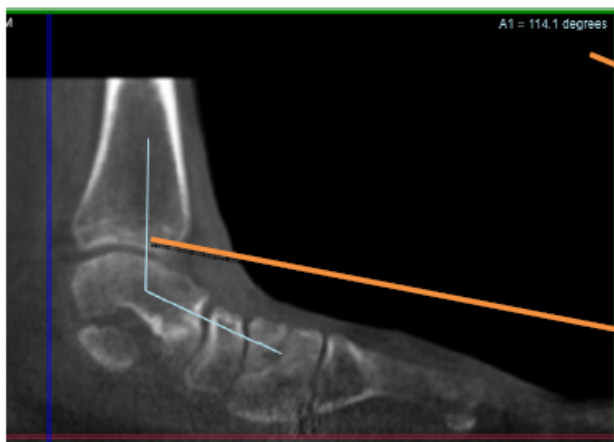

Angle Measurement Values

Simple Angle Measurement

Cobb Angle: Select “Cobb” to enable the Cobb angle Tool. The Cobb angle requires creating 2 separate lines and the tool will calculate the angle at the point of “intersection” of those 2 lines:



These 2 lines are drawn when "Cobb" is enabled (4 clicks). The calculated angle measurement is where these 2 lines intersect.

Correlate Cobb Angle: Create 2 sets of "Cobb" lines and then select "Correlate Cobb" to calculate and angle where the 2 yellow dotted lines intersect:

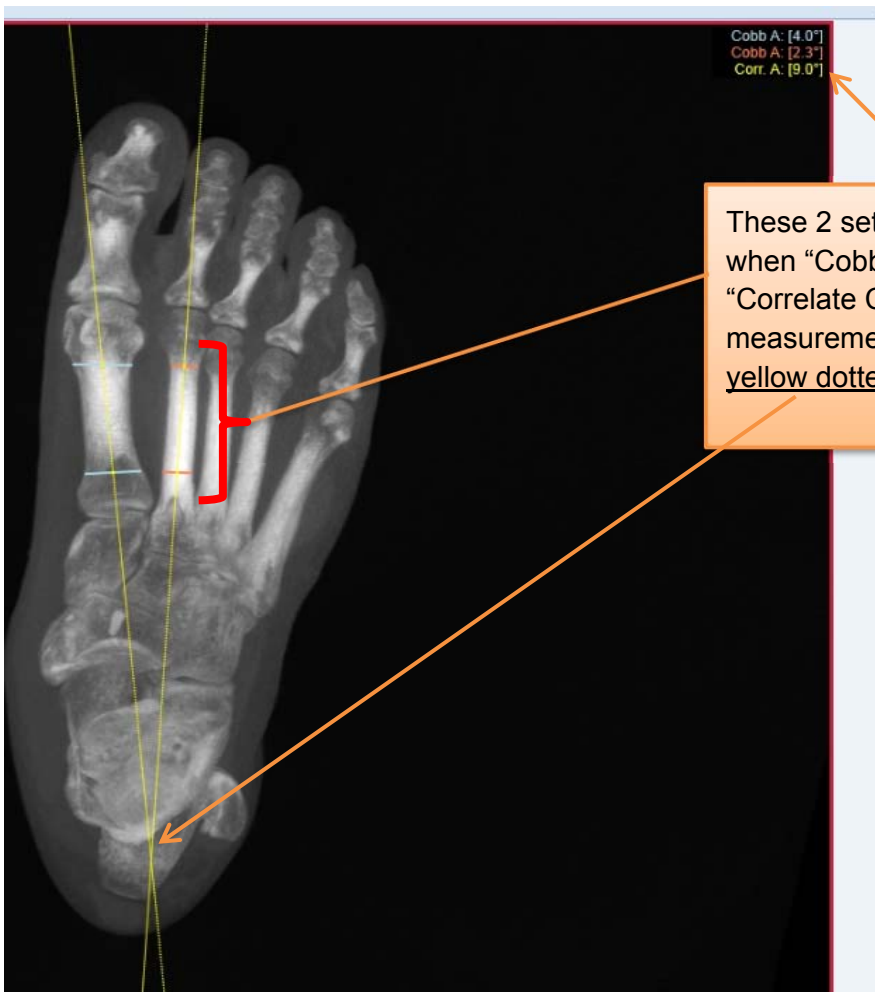

These 2 sets of Cobb lines are drawn when "Cobb" is enabled. Then select "Correlate Cobb" to calculate the angle measurement where the resulting 2 yellow dotted lines intersect.

Distance Measurements:

Select the Distance Tool icon to enable the distance tool. Distance has 2 points of reference. Point, click, drag, release to create a line. This will result in length measurement in millimeters, and the measurement will display in the upper right hand corner of the window. A maximum of 10 measurements can be made in one image window. This tool will remain enabled until disabled by clicking the selection again.

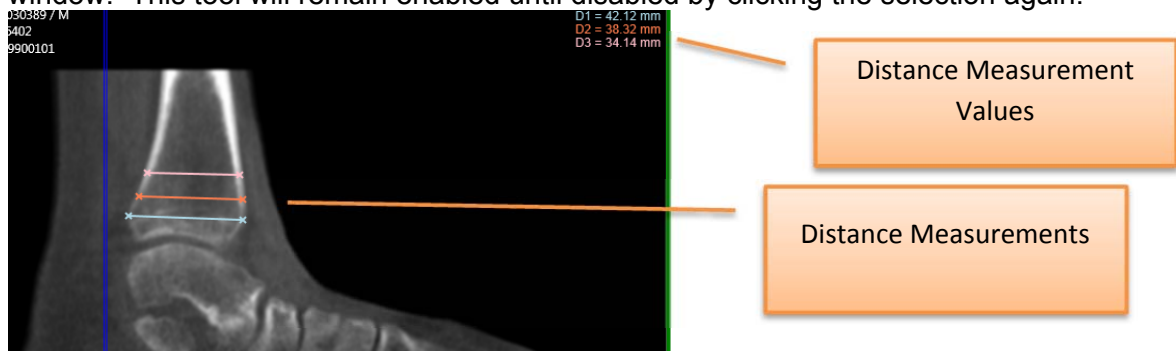

Removing Measurements:

All measurements can be removed by hovering over the values in the corner and right clicking on them. This will display a pop up window. Select either *Remove measurement* which will remove the last one drawn on or *Remove all measurements* which will remove all from both the corner and the illustration on the image.

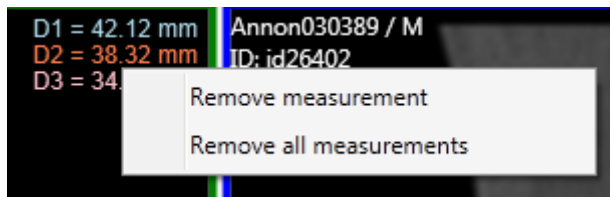

Ruler Settings:

Also Note that there is a Ruler Tool that can be displayed on the bottom of the image window for quick distance measurements. This overlay can be enabled or disabled by clicking on the "Ruler Settings" icon. Click Show Ruler to display the yellow ruler at the bottom of the image window.

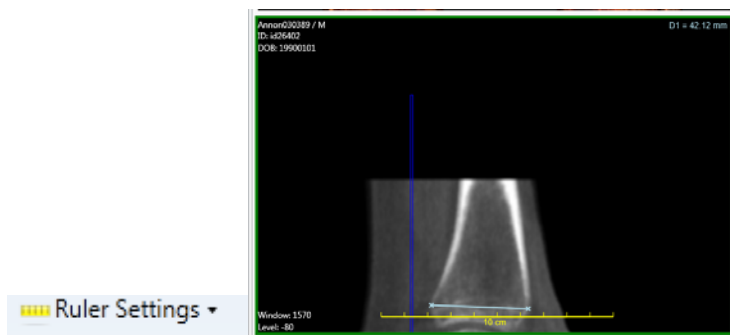

MPR Tab:

The MPR Tab has available the 3 MPR views and no 3D Rendering. One additional tool within only the MPR Tab is the “MPR Cut” tool. This tool is only enabled when you are on the MPR Tab and is in the “Options” area.

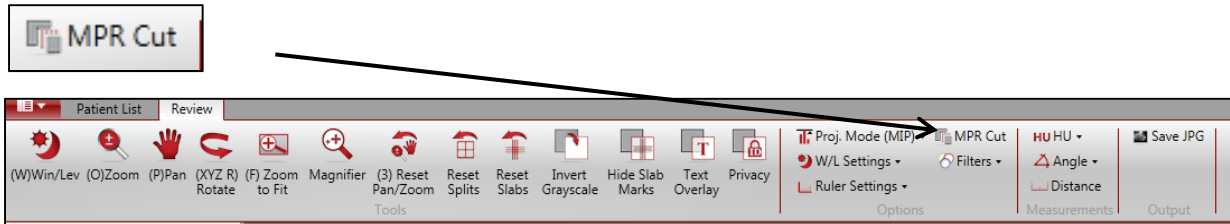

When MPR Cut is selected, the cursor now allows the user to draw a “cut line” on any of the 3 MPR images in order to display a customized slice in any direction in the lower right hand corner Window.

The cut line can be straight or curved. For a straight cut line, click in 2 spots, then double click to complete the sequence. For a curved cut line, make multiple clicks in a curved direction.

MPR Straight Cut Plane: Created in the Axial view. The resulting cut displays in the lower right corner.

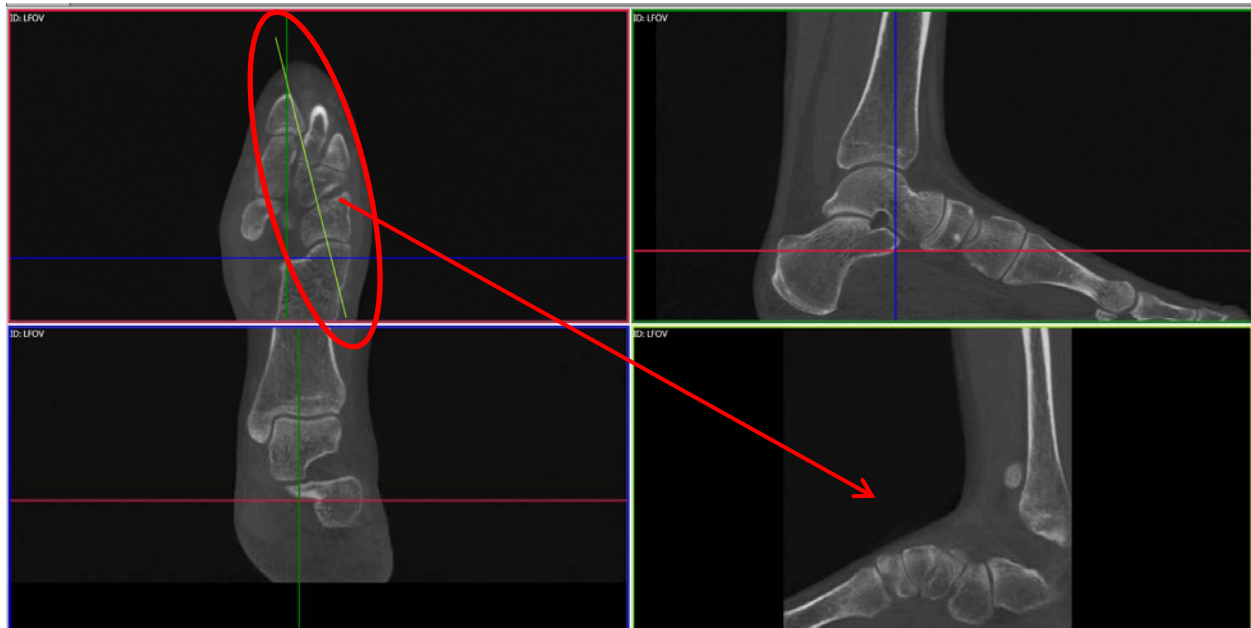

MPR Curved Cut Plane: Created in the sagittal view. The resulting cut displays in the lower right corner.

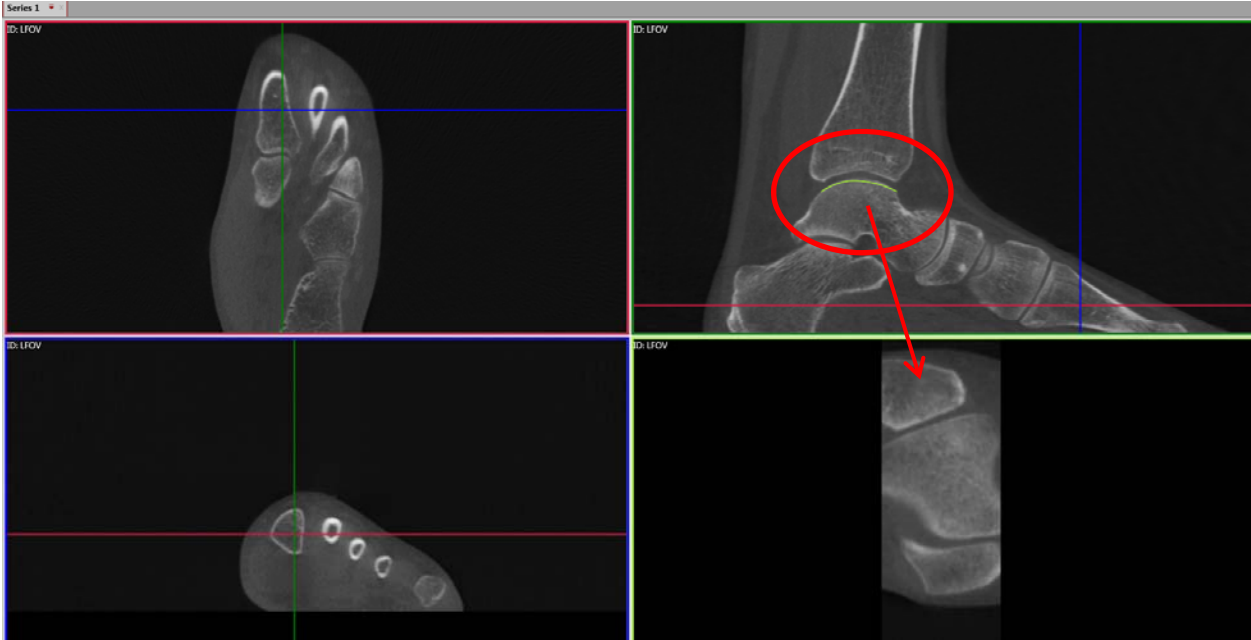

Tools and Settings Panel:

REVIEW CONTROLS:

Sync Window/Level: when this item is “checked”, any Window/Level adjustment to an MPR image will make the same adjustment to the other MPR images.

Sync. Zoom: when this item is “checked”, any Zoom adjustment to an MPR image will make the same Zoom adjustment to the other MPR images.

Sync 3D/MPR Rotation: When this item is “checked”, any rotation of the 3D rendering will also rotate all 3 MPR images to the same angle.

Sync 3D/MPR Rotation button: When this button is clicked on, the MPR images will snap to the rotation angle of the current 3D rendering rotation.

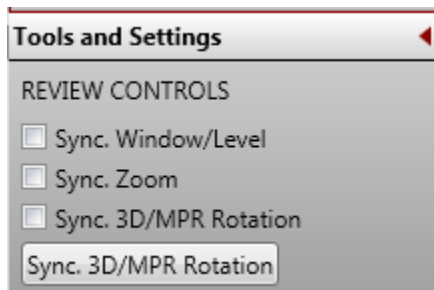

3D/MPR Rotation, (Volume Rotation, Volume Tilt):

The default image planes of MPR views are as the scan was taken. However, if you wish to rotate or tilt the MPR images to different planes, this can be achieved using the 3D rendering and the Sync 3D/MPR functionality.

Below is an example.

If this is the starting view below and then 3D image was tilted upwards either with the Sync 3D/MPR Rotation or by clicking the button after the rotation, then the MPR rotation will change from picture A to picture B:

Picture A: the 3D rendering is in an A/P direction.



Picture B: The 3D rendering has been rotated with the toes up slightly. Observe how the upward tilt of the 3D rendering is now reflected in the MPR views. The first metatarsal is now on the same horizontal plane.

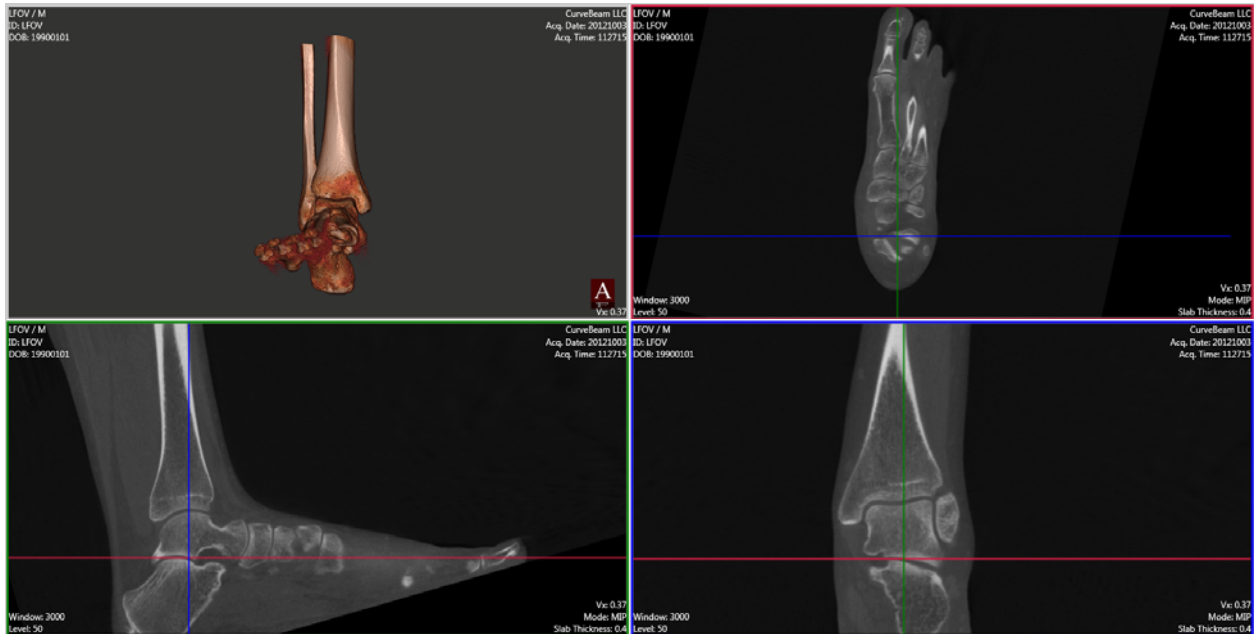

For fine control of the X, Y and Z rotations of the 3D rendering, press the associated keyboard letter and HOLD while rotating the 3D image.



X key: Hold the key down and move the mouse up or down on the 3D rendering. This will tilt the rendering in an even up / down plane.



Y key: Hold the key down and move the mouse left or right on the 3D rendering. This will tilt the rendering in an even side to side plane.





Z key: Hold the key down and move the mouse in an up or down direction and this will move the 3D rendering clockwise or counterclockwise.



3D Renderings:

The 3D Rendering image displays in both the Combined 3D/MPR Tab and the 3D Tab. The combined allows the user to scroll through MPR slices for Viewing/Planning as well as edit and manipulate 3D renderings. The 3D Tab only displays the 3D renderings. However, the 3D Tools are similar for each.

Combined 3D/MPR Tab:

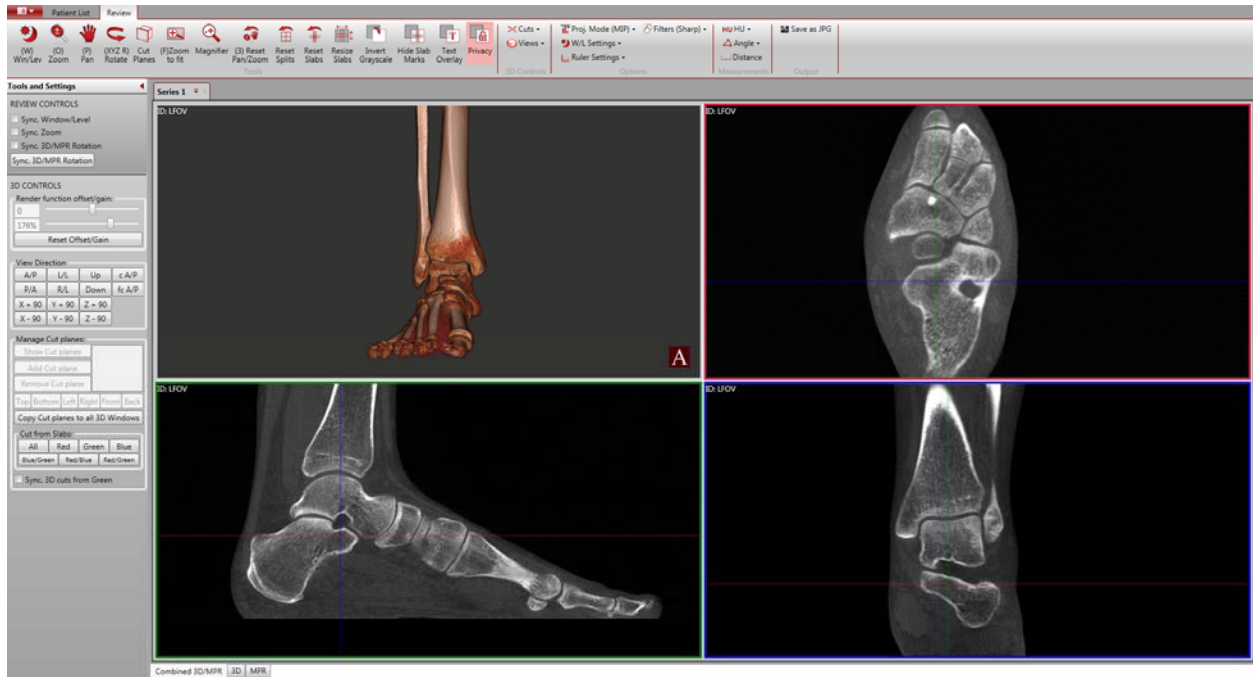

3D Tab:

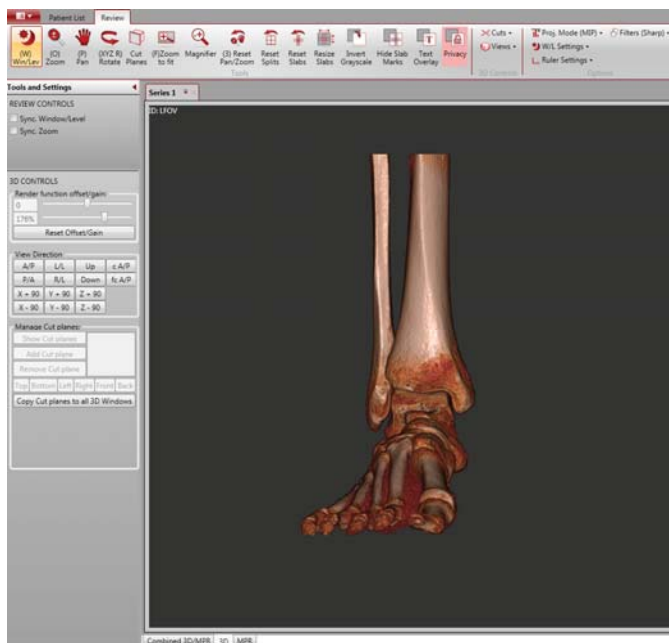

The Zoom, Pan & Rotate buttons on the Main Menu Bar all can be activated and used in the 3D Rendering window.

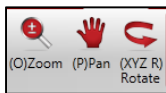

3D CONTROLS: the 3D CONTROLS within the Tools and Settings panel contains most of the 3D rendering functions.

Render Function offset/gain: **These tools adjust the thresholding for the 3D rendering.** Drag the slide bar to adjust from soft tissue to bone and vice versa. To reset both back to zero, click the Reset Offset/Gain button.

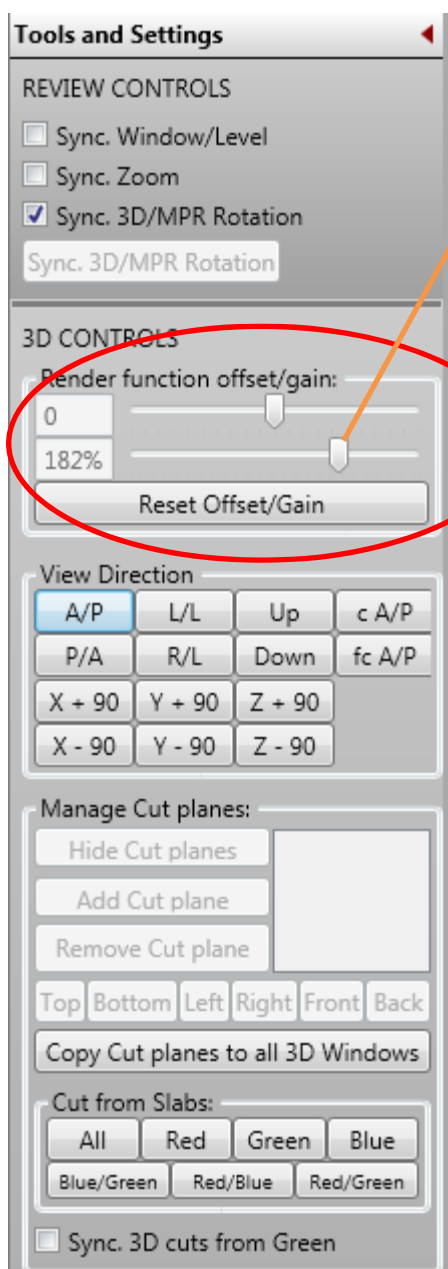

Slide to adjust thresholding for the 3D renderings from A to B.

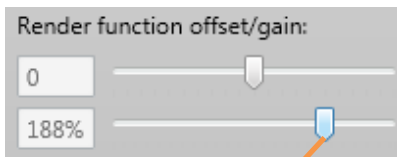
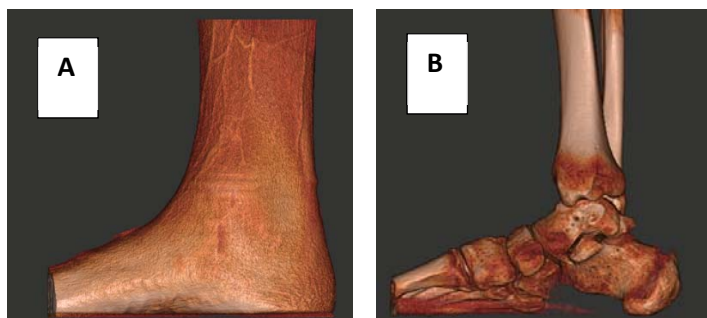







To Fine Tune the thresholding in small increments: when the slide bar is highlighted in light blue color, use the keyboard arrow keys left and right



View Directions:

| View Direction | | | |
|----------------|--------|--------|--------|
| A/P | L/L | Up | c A/P |
| P/A | R/L | Down | fc A/P |
| X + 90 | Y + 90 | Z + 90 | |
| X - 90 | Y - 90 | Z - 90 | |

There are automatic snap to View Directions for a quick rotation of the Rendering to a desired view:

| View Directions | | | |
|------------------------------------|---|---|---|
| A/P (Anterior / Posterior): |  | Up (looking up into bottom of foot/feet): |  |
| P/A (Posterior / Anterior): |  | Down (looking down onto top of foot): |  |
| L/L (Left Lateral): |  | C A/P (Conventional Anterior / Posterior): down, 15 degrees from vertical. |  |
| R/R (Right Lateral): |  | | |

Cut Planes: To cut a 3D rendering from an entire plane, first click the **Cut Planes** icon from the Main Menu Bar to activate the functionality.

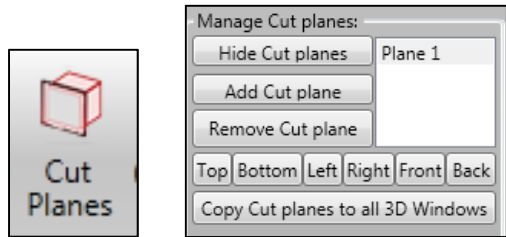

Once enabled, a cut plane is placed within the center of the 3D Rendering. Also, the “Manage Cut Planes” tools will be enabled in the 3D Tools area.

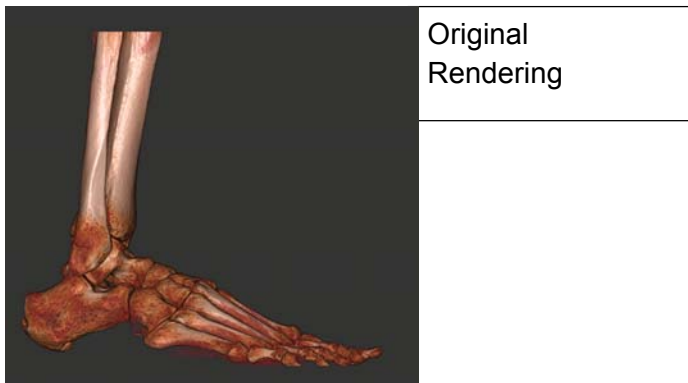

After clicking on **Cut plane** icon. A cut plane will Auto drop into the center of the volume and cut out half the 3D rendering. *Manage Cut Plane Tools* will also be enabled.

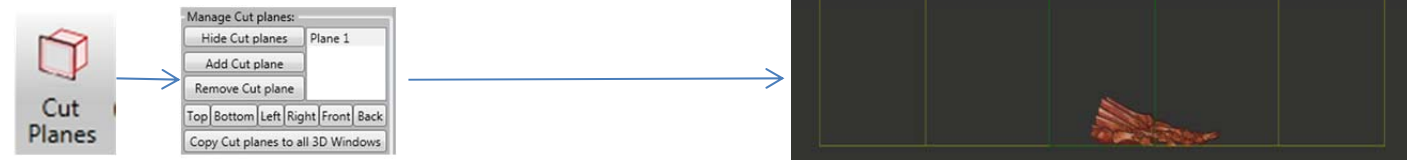

To Insert the Cut Plane in any direction, Utilize the “Direction buttons” in the *Manage Cut Planes* Tool area.



In this sample we clicked on the “Front” Button to cut away the front half of the rendering.

NOTE: The angle of direction of the cut plane can be adjusted to any angle by holding down the CTRL key and dragging the mouse in any direction.

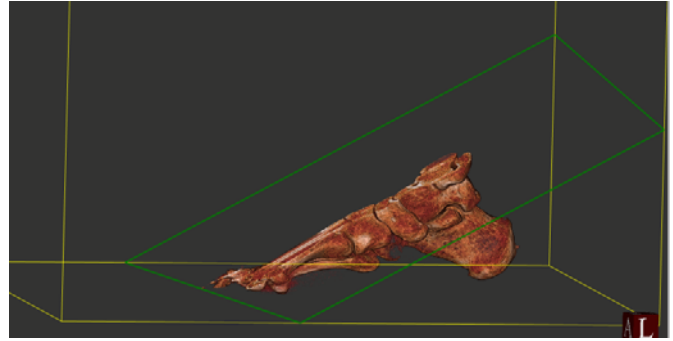

Peeling Away the rendering:

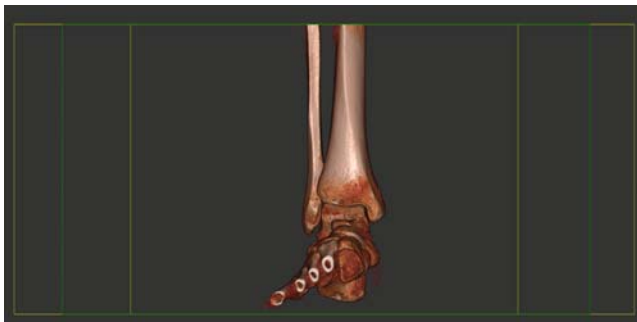

In this sample, the rendering has been rotated to an A/P view for viewing the metatarsals.

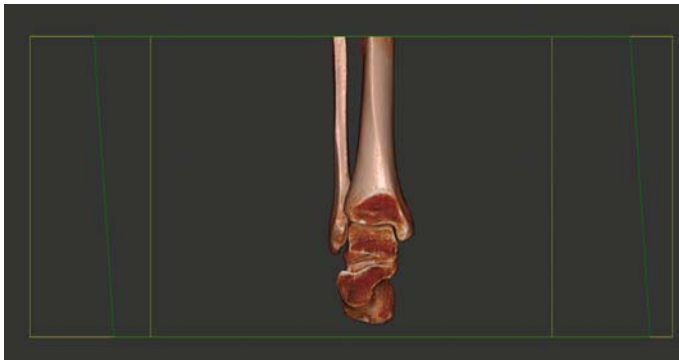

Now, the rendering can be cut more (peeling away) or restored more, by holding down the SHIFT key on the keyboard and moving the mouse up and down.

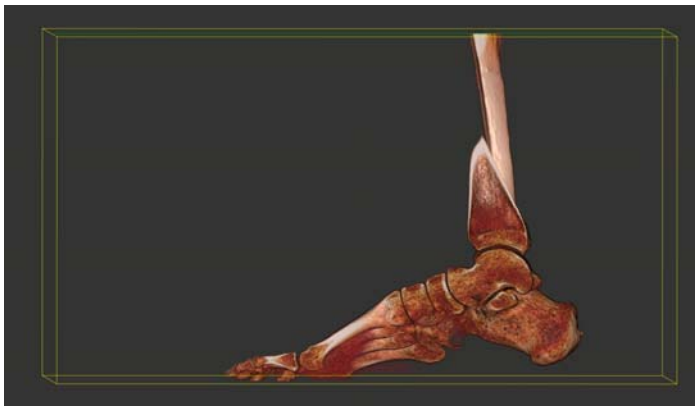

This cut plane was rotated to a sagittal plane by clicking the "Left" button to cut through the foot from the medial side.



Multiple Cut Planes can be inserted and manipulated by clicking on “Add Cut Plane” button. To Remove Cut Planes, highlight the Plane in the list (Plane 1, Plane 2, Plane 3....) & click on the “Remove Cut Plane” button. To Hide a Cut Plane, highlight that Plane in the list and click on the “Hide Cut Plane” button.

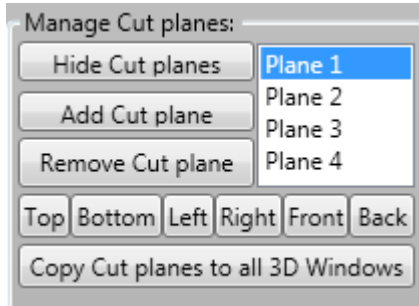

If desired, to transfer the 3D Rendering that was just designed to the other 3D Window click on the “Transfer Cut Planes to all 3D Windows” button. Otherwise, the other 3D window will be a fresh rendering.

Cut From Slabs:

Another method of cutting a 3D Rendering is to “Cut From Slabs”. In order to Cut from Slabs, you must first create Slabs in the MPR image(s). Then use the “Cut From Slab” Buttons to make the cut(s) on the 3D image.

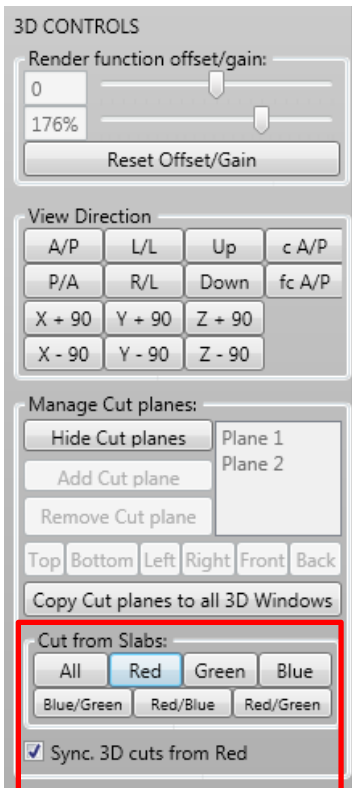

For example, if you wanted to cut just one section from the rendering, you could use the sagittal view to create a slab, and then click on the “Red” button.

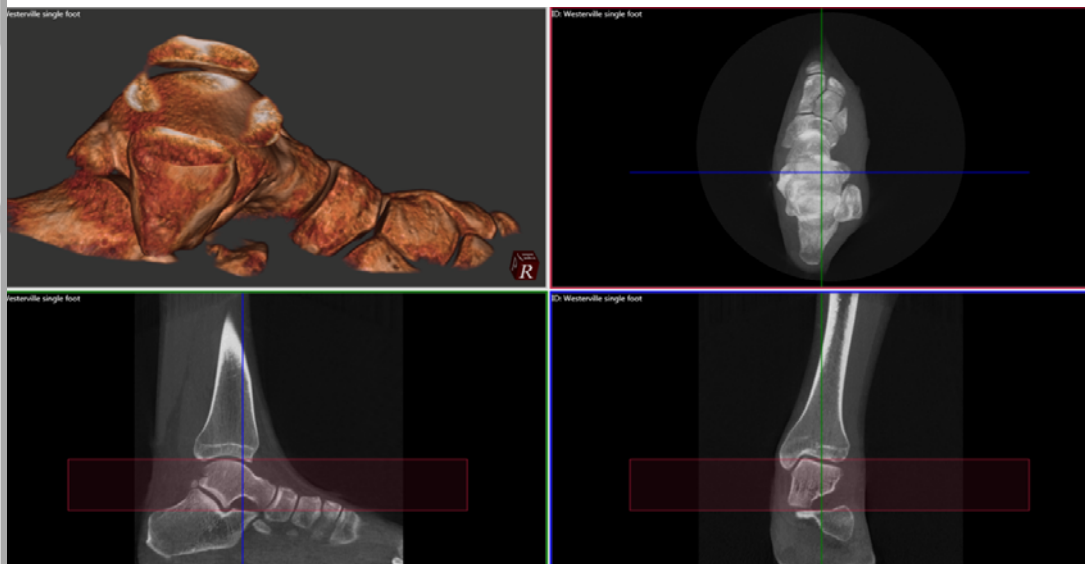

Or you can cut from 2 or all 3 slabs. In this example below, a slab was created in all 3 MPR views and the “All” button was clicked:

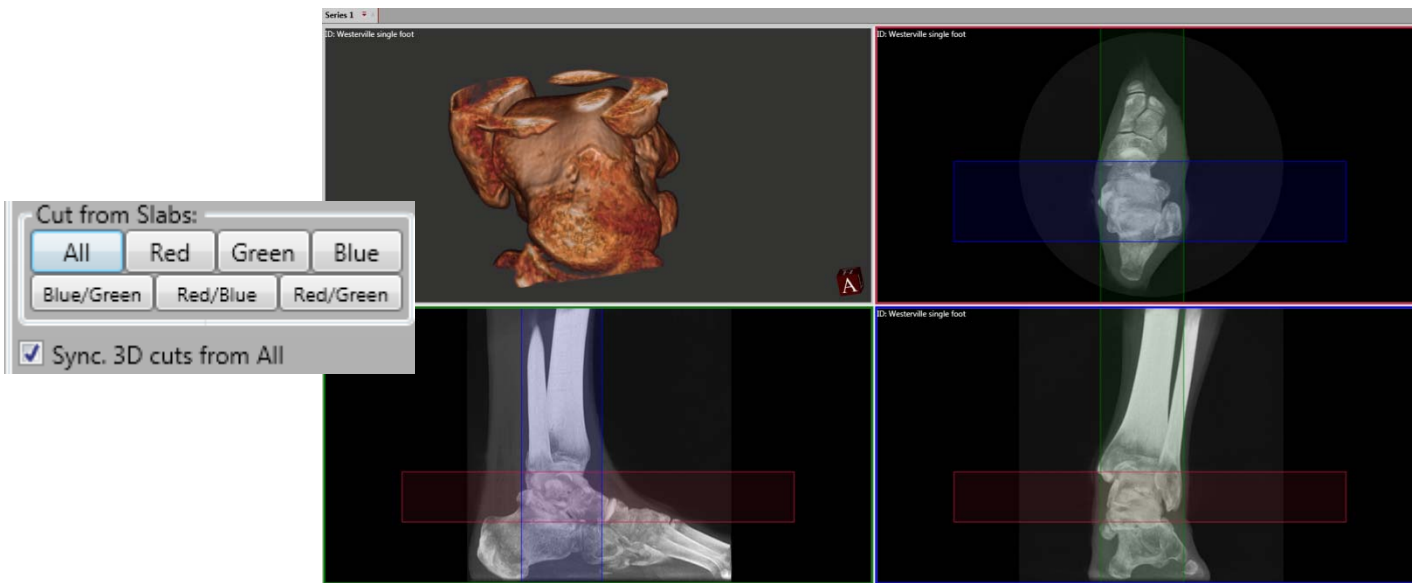

Note: to restore the original 3D rendering, click on the “Hide Cut Planes” button under Manage Cut Planes.

Render Types:

To select various 3D Rendering types, click on the Views icons in the 3D Control area. This will display a pop up window with various options to select from. Select Render Type.

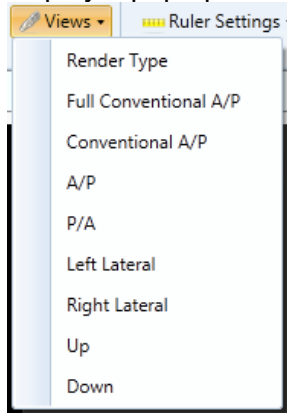

When Render Type is selected, a window will display thumbnails of the various default types of 3D renderings currently available. They are:

1. bone_skin
2. bone_skin2
3. bone_transparent skin
4. transparent_colorized
5. x-ray

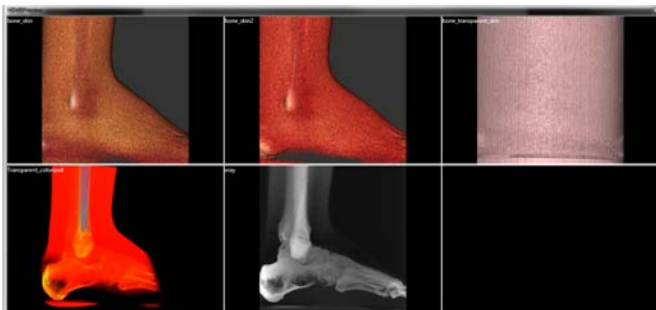

When one of these options is selected, that render type will display in the 3D Render window. Now you can adjust the rendering by using the Render function tools and dragging the slide bars. The most effective change of renderings will come from the slide bar.

Saving Sessions and “Series” Tab Functions:

When a study is loaded, the Patient Series Tab will display that current study name. The dataset can also be closed or “unloaded” from this tab by clicking on the “x” in the corner. The session work that has already been completed will be auto saved, so when the study dataset is re-loaded again, the sessions work will automatically load.

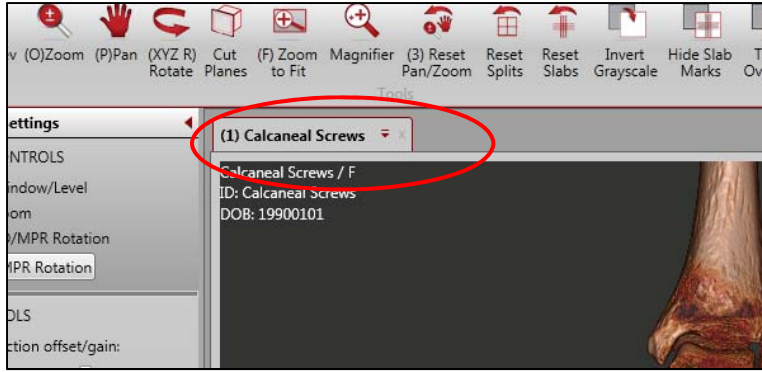

However, there is also a Drop Down Menu that provides a “Save Session” functionality so that you can save several different planning’s.

Click the Drop Down Icon to access the Drop Down Menu to Save Session:

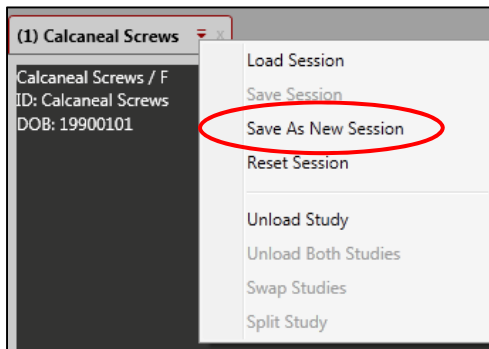

From this menu, then select “Save As a New Session” for the Session Manager Dialog Box. Enter in an appropriate Session Name over the “Type a Description” Session Description. Click inside this text box to enable the cursor for typing. Click OK to close the Session Manager.

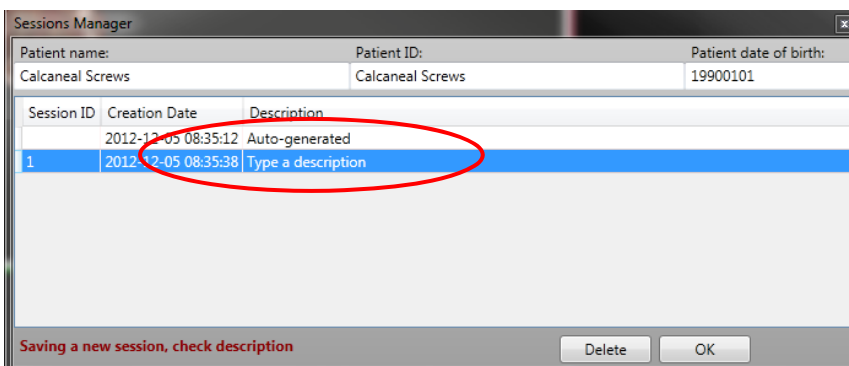

Then at any time, a Saved Session can be accessed and loaded by selecting “Load Session” from the Drop Down Menu. This will open the Session Manager where you can then highlight the desired Session and click OK to load.

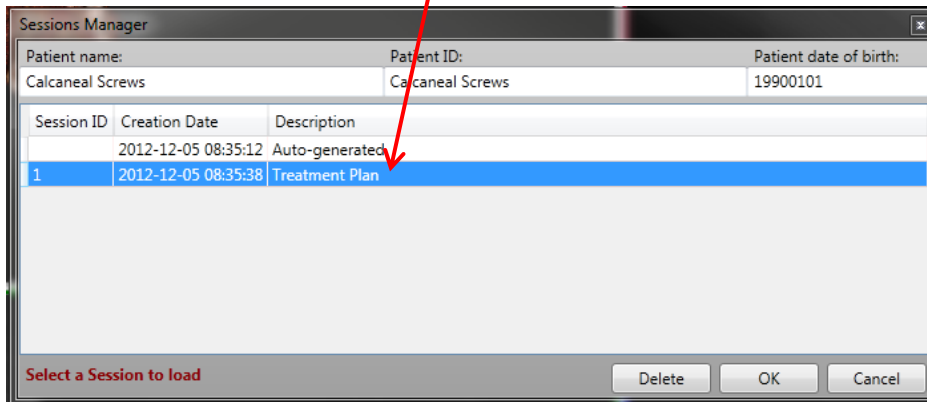
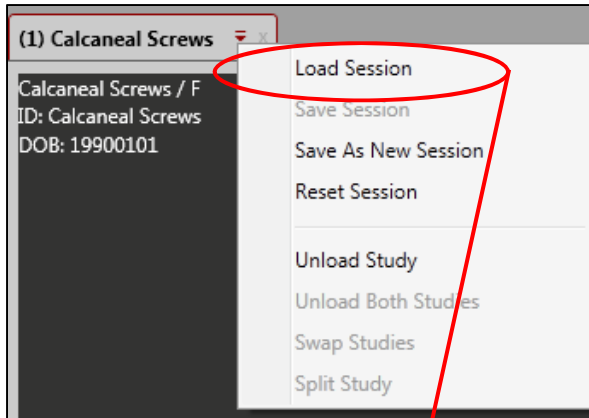

From the Drop Down menu, the Dataset Study can also be Reset, which will re-load the original dataset to its pre-worked state. And a Dataset Study can also be “unloaded” from this drop down menu as well.

Input: Load Function

The Load function is provided to allow the scan to be viewed in CubeVue, either the Raw or Recon file. But, when using the Load function, the patients scan will NOT be added to the existing Patient List. Any changes to the scan that are made, measurements, etc, will not be saved. The scan will not be added to the database of scans available to view.

To perform the Load function, click on the Load icon from the Patient List tab:



Then follow the steps to load the study into temporary memory for CubeVue. Remember, any plannings done will not be saved.

Input: Import Function

A patient's study can be Imported to add it into the current patient database. When this is done, the patient's scan and any work done on that scan will be stored on the PC with the other scans in the Patient List. To Import a study, click on the Import icon from the Patient List:



Then there will be a pop up box that will ask for the Input Location. Once that is provided, the study will be in the database on the current PC.

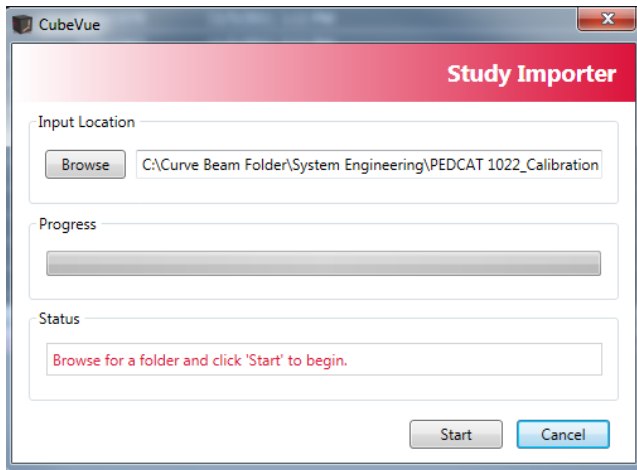

Output: Saving Images as JPG images

To save any one individual image as a JPG, click it to highlight and then click on the Save JPG icon, then select the location to save to.

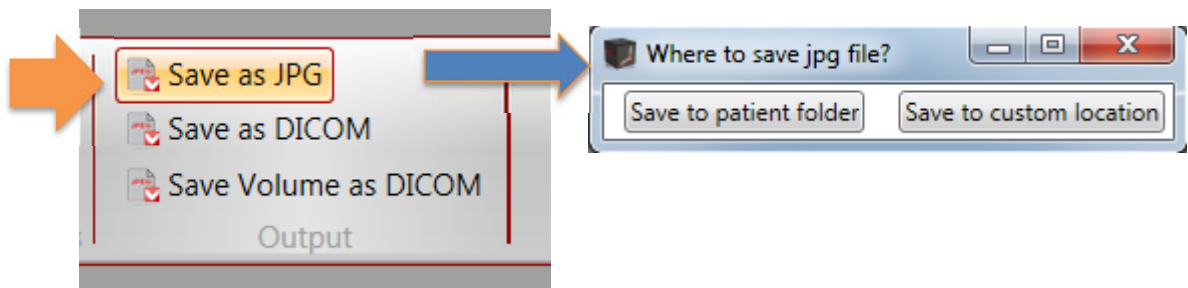

If Save to patient folder is selected, the file will save to the patient's folder and remain there. The JPG can then be exported using Media Export if desired. If Save to custom location is selected, there will be a prompt to browse to the desired location.

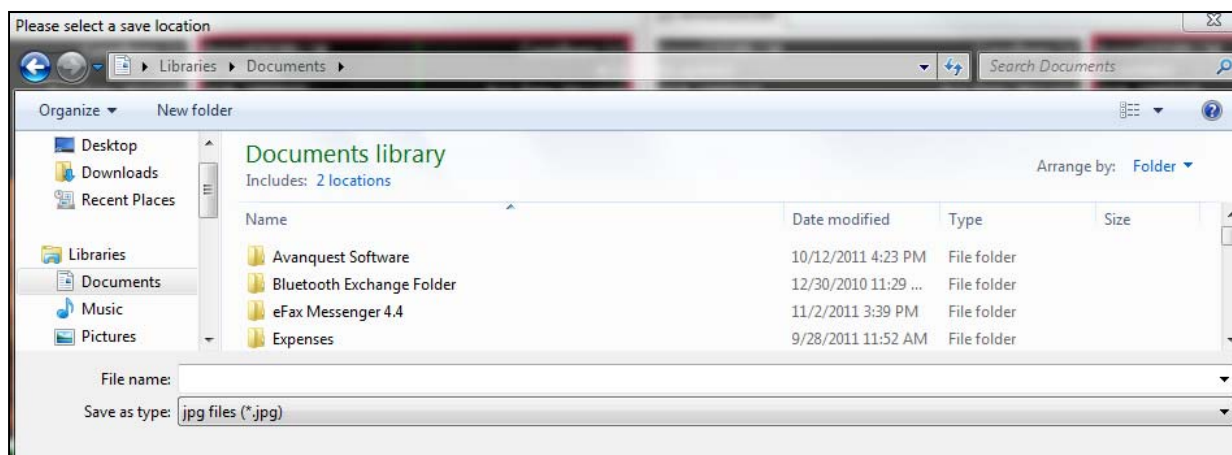

Output: Media Export

Burning a DISK with a free CubeVue Viewer: The software has functionality that will allow for an auto burn of a disk that contains the desired dataset(s) along with a limited-function copy of the CubeVue viewing software. The limited-function viewer does not have volume render capability. The receiving user of this disk can then open the dataset(s) in the CubeVue software for viewing. This function allows the end user to also export and burn individual images of 3D renderings, or any image of choice to the disk which can then be viewed via the CubeVue viewing software. This is useful if the receiving user does not possess one of our 3D licenses necessary for building 3D renderings. (If the receiving viewer desires to have full 3D rendering functionality, they can purchase that license through CurveBeam). Media Export will also export any CubeVue Saved Sessions associated with a dataset.

There is a Tab on the upper Menu which is called Media Export. This Tab is used specifically for creating a dataset CD with CubeVue self installer.

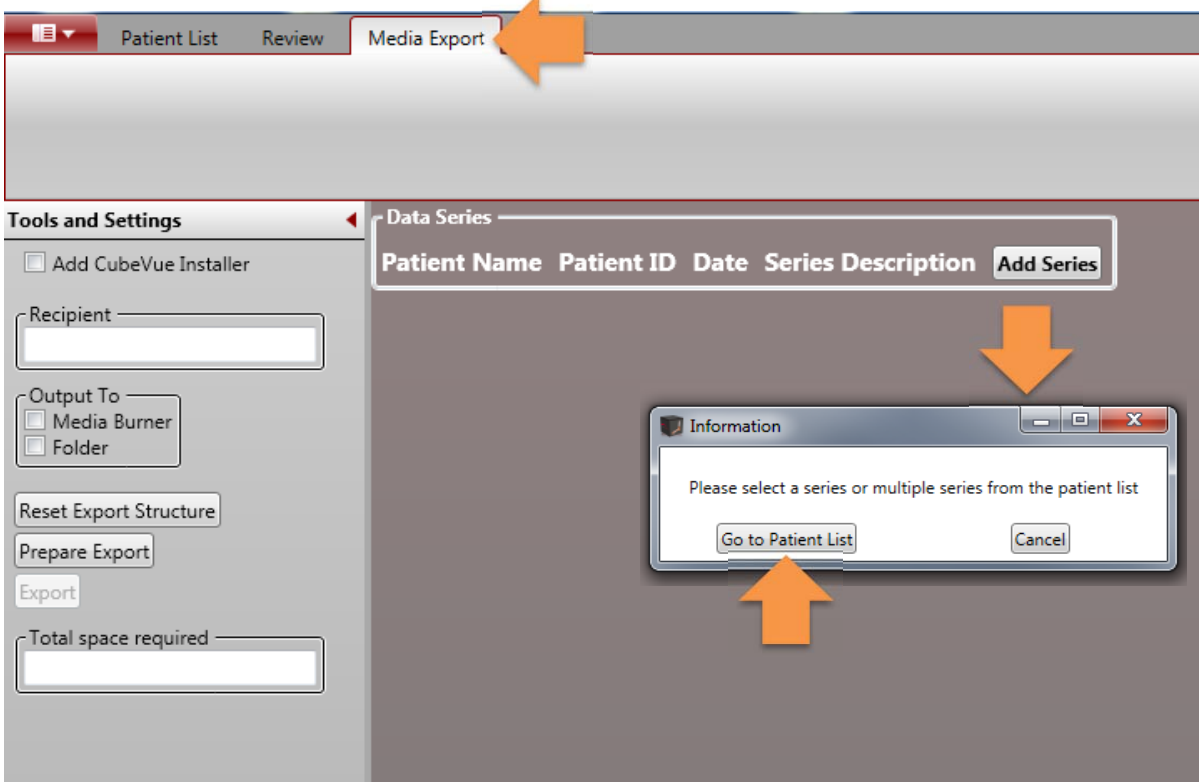

The first step is to click the Add Series button. This will return to the patient list for selecting a dataset(s) to burn.

- From the Patient List, highlight the desired series to be burned to the CD and right click on the series to access the new Pop-up box. Select the new item named “**Media Export**”. This will automatically add the series into the Media Export list.

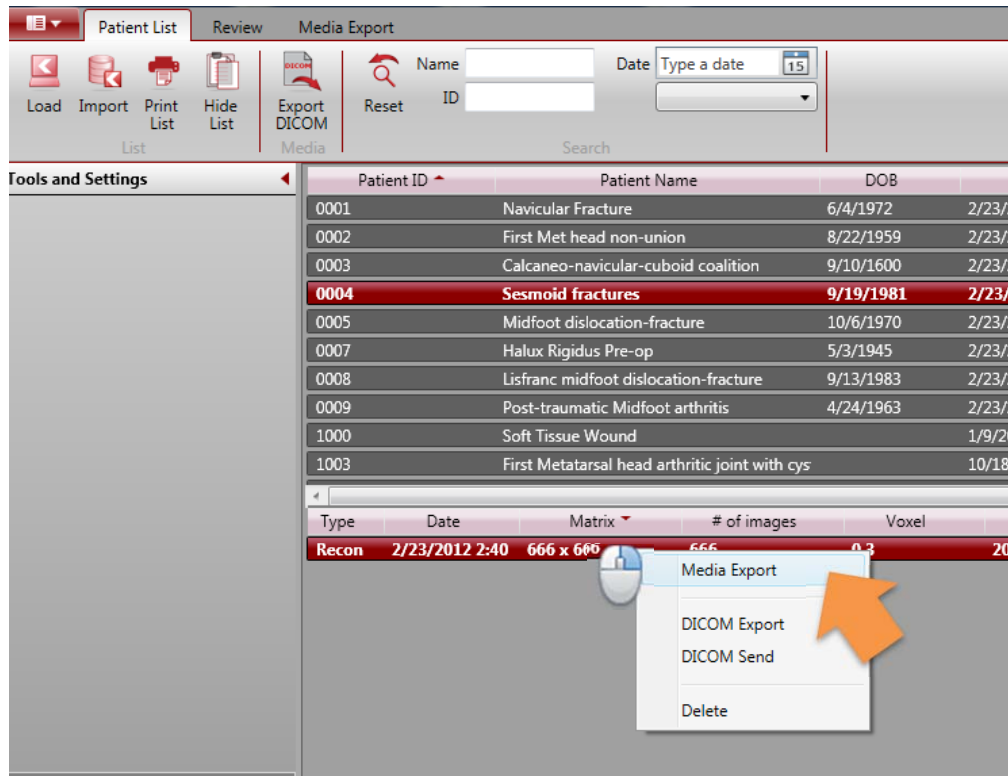

- Now click the Media Export Tab again and see the Selected Series saved in the list
- Multiple series can be added in the same method if desired.

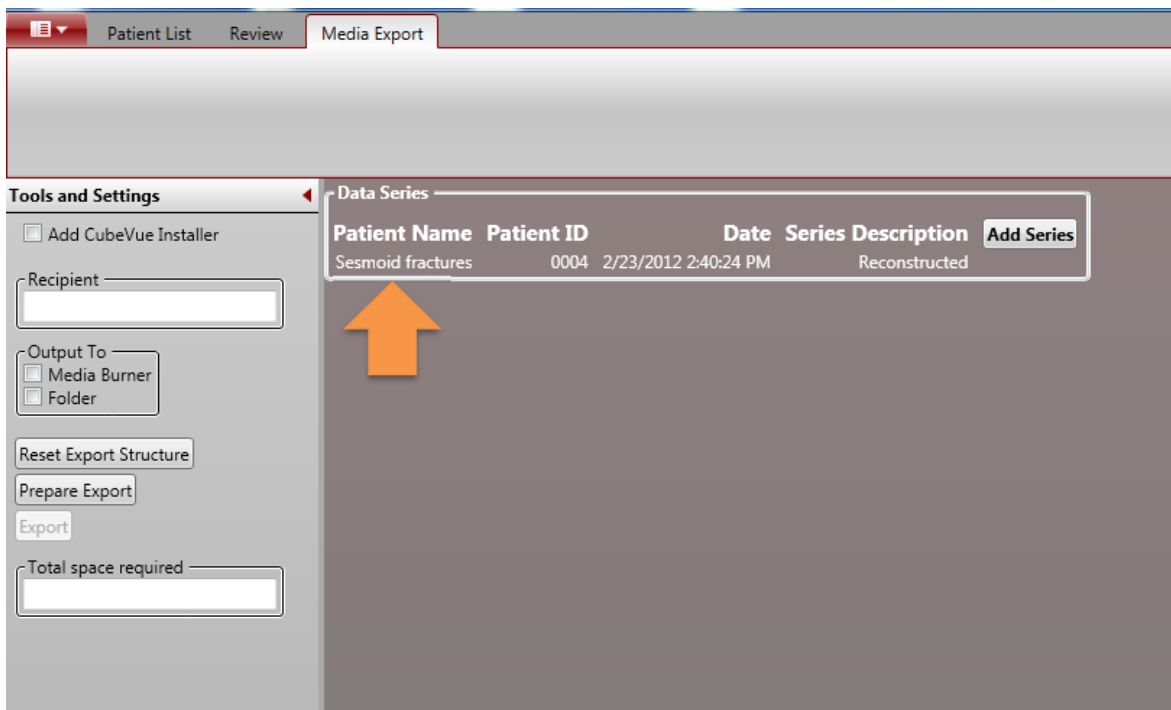

Also, if the user wishes to Add JPG images from this case into the Media Export Data Series List, open the series and in Review Tab, save one or multiple JPEG images to the Patient Folder. Then these will show up in the Data Series List as thumbnails. Each has a check box for selecting which to choose to be included in the Media Export. Double click on the thumbnail to enlarge for viewing if desired.

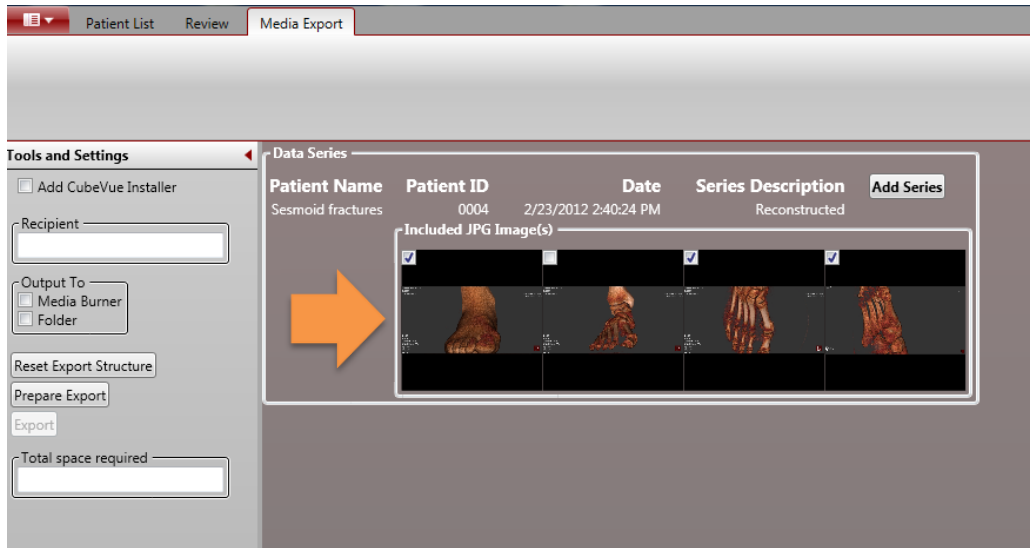

- Next, complete the items in the **Tools and Settings** section:

This section provides a detailed view of the 'Tools and Settings' panel with callout boxes explaining each field:

- Add CubeVue Installer:** Always Check this box to add the CubeVue Installer to the Media.
- Recipient:** This box is **Mandatory**: A Recipient Name must be filled in or the Export button will not enable.
- Output To:** Choose the location for the output. If you want it to go to a folder or USB drive instead of a Disk, select "Folder".
- Reset Export Structure:** If this button is clicked, all the data under Data Series will be reset to no data.
- Prepare Export:** Once you have selected the Output To item, click the Prepare Export Button. This must be done before the Export button is enabled.

Once the Prepare Export Button is clicked, the **Total space required** field will auto fill and the **Export** button will enable.

- If selected Output is to a Media Burner (disk), **INSERT the DISK NOW** into the disk drive.

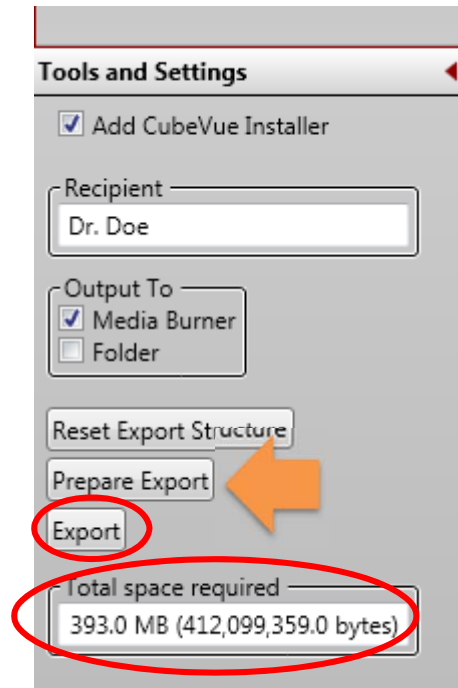

- Next, click the **EXPORT** button and the status bar will activate. When completed, a Balloon at the lower right hand corner of the screen will pop up. Click on the pop up.

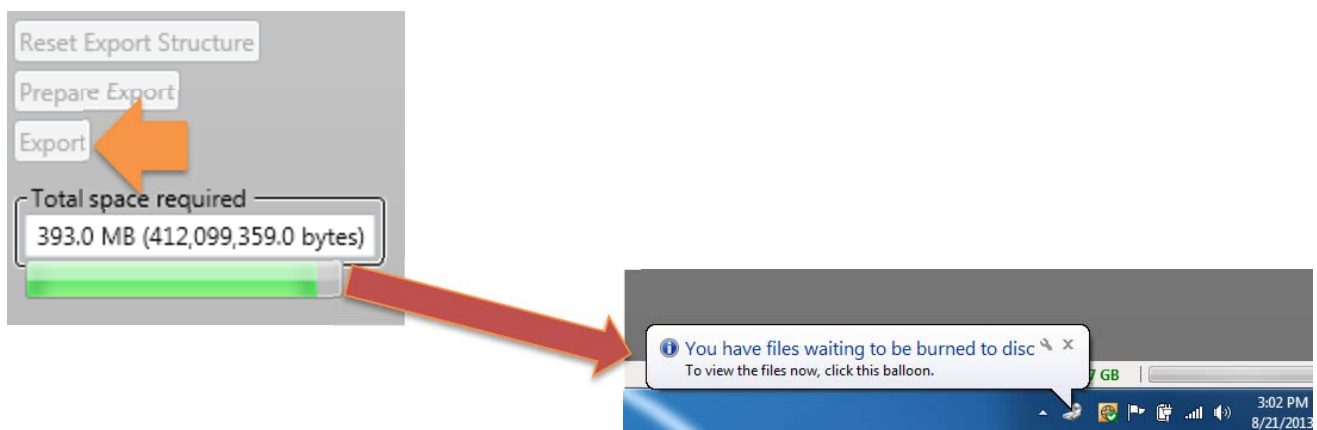

- If the Balloon disappears before you had a chance to click on it, go to START/Computer and click on the CD/DVD Burner Drive. Notice the **“Files Ready to Be Written to the Disk”**

- From this *Files Ready to Be Written to the Disk* Window, Click on the **Burn to Disc** button.
- This will open the *Burn a Disc* Window. Select **With a CD/DVD Player**, click **Next**.
- This will open the *Burn to Disk* Window. Click **Next**. This will initiate the auto burn. The CD will eject when completed.

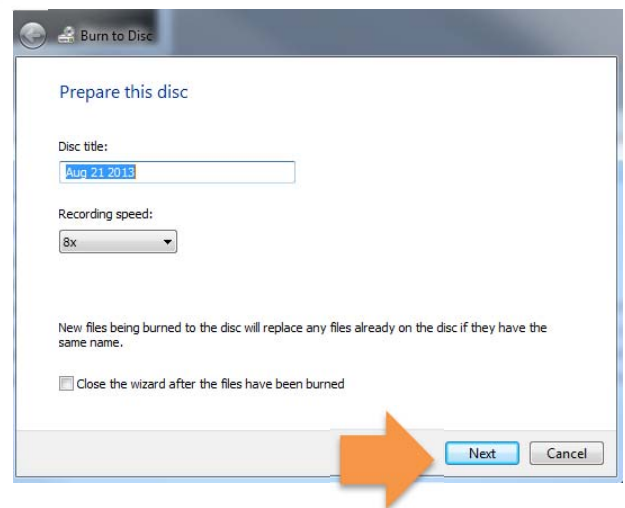
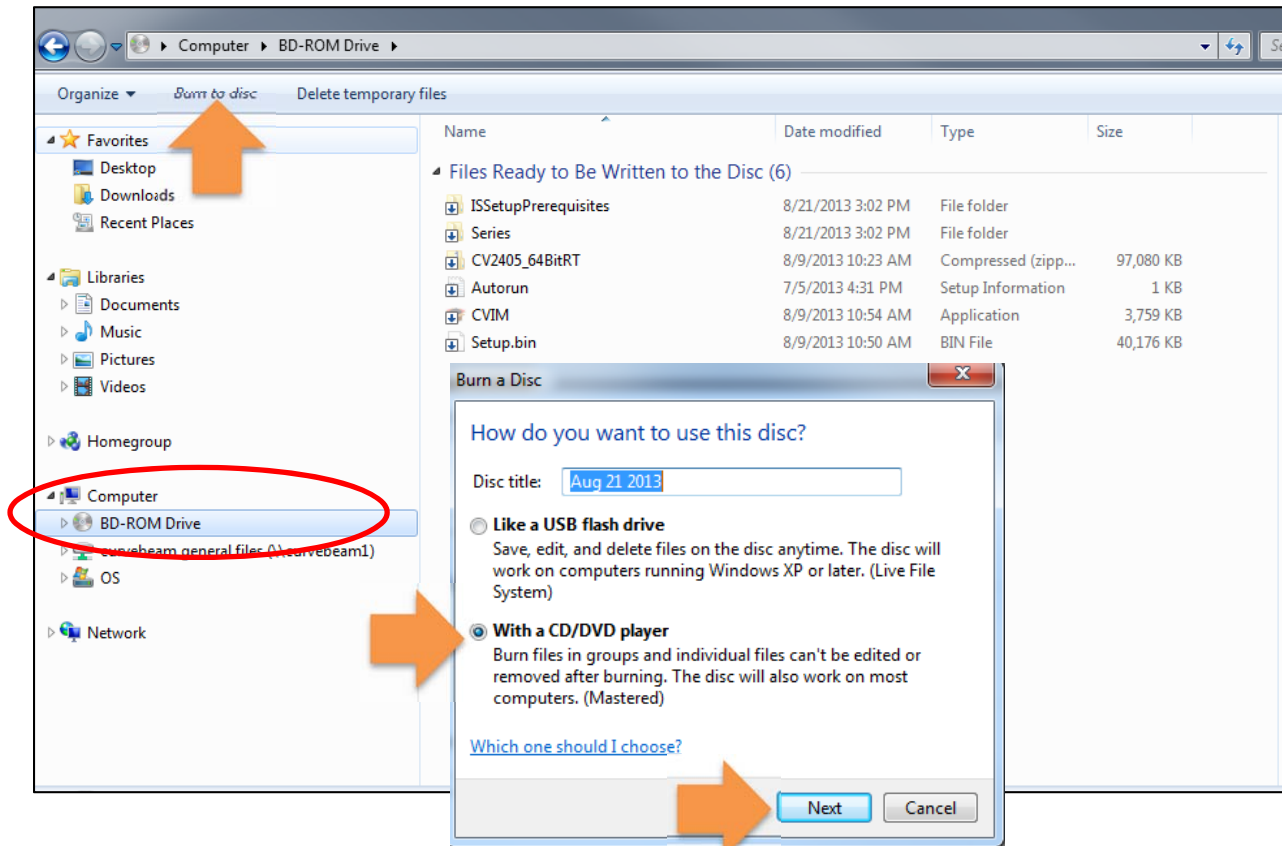

Media Export to a Folder:

- Add the desired Patient Series as described in the previous instructions.
- If you wish to perform a Media Export to a Folder or a USB Drive, select the **Output To** location as **Folder**.
Note: a Media Export to a folder requires an Empty Folder, so it would be best to Create a New Folder to export to.
- Select **Prepare Export**
- Select **Export**, there will be a prompt to **Browse to** the desired folder. If there was no folder previously created, select “Make New Folder” and then name appropriately.
- Click OK.
- The **Overwrite Warning** message will appear if the selected folder contains ANY files. **ALWAYS** select an empty folder or click “Make a New Folder” to create a new folder for export, or if you click OK, then the existing files will be deleted and the Media Export files will replace them.

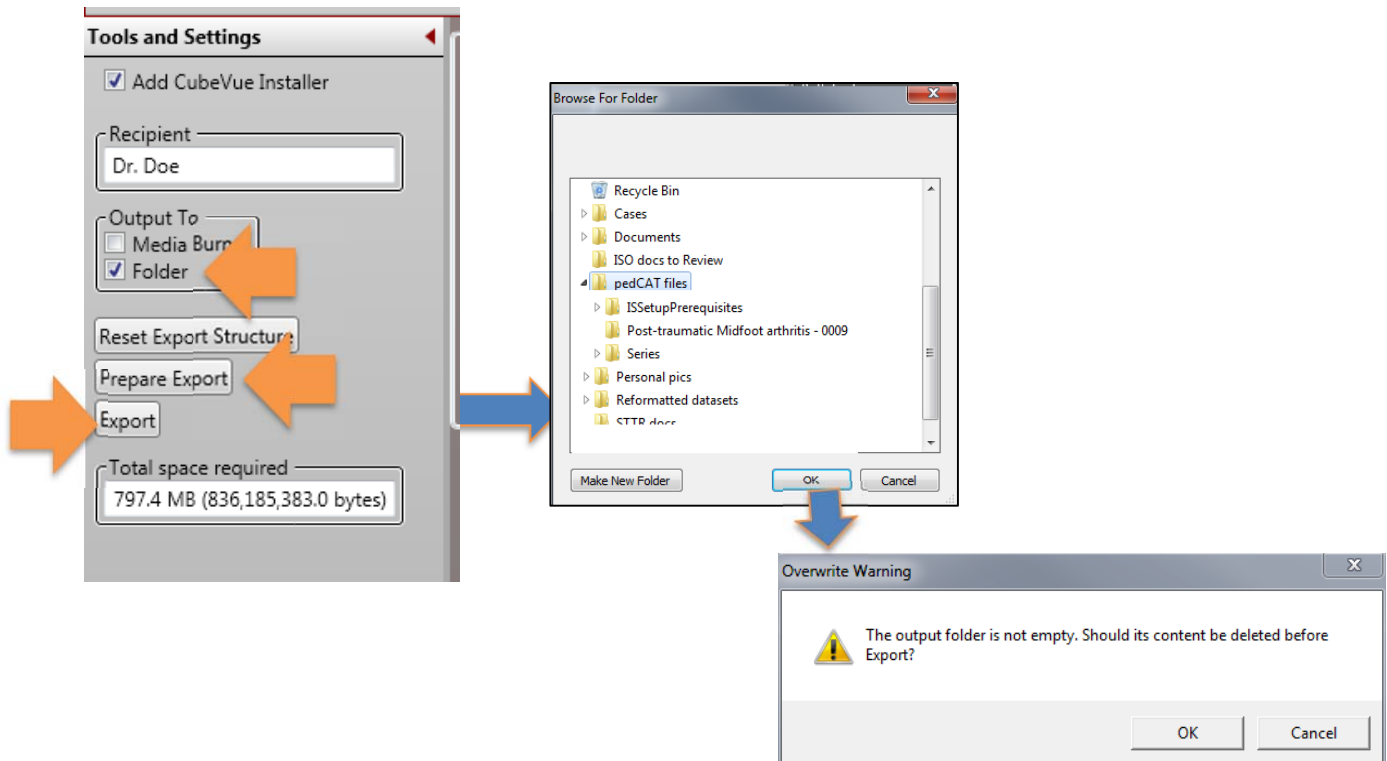

Installing a Media Export CD on a fresh computer, with CubeVue Installer

- Insert the disk into the disk drive. From AutoPlay, select **Open folder to view files on the disk**.
- Run the **CVIM.exe application** file As Administrator to launch the CubeVue Install Manager.

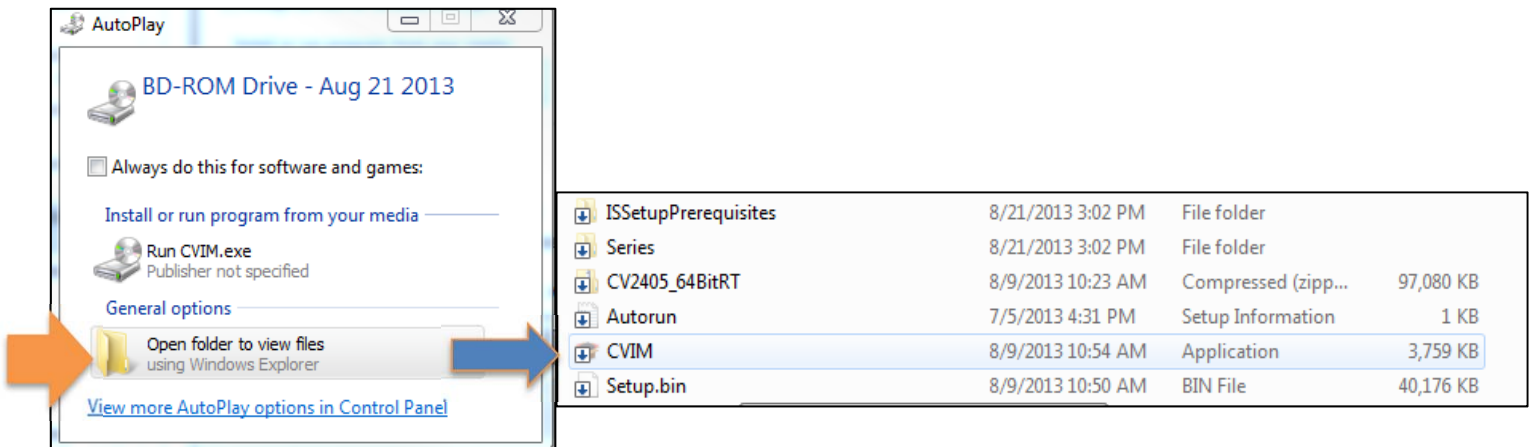

- In the *CubeVue Install Manager*, Click **Install CubeVue & Import Data**. If CubeVue is already installed the Install CubeVue button will be disabled, so just import the data by clicking the **Import Data** button. The dataset as well as any Saved Session files and Save as JPG to patient folder files will import. Note: If there were JPEG images that were Saved to Folder on this Media, then those can now be viewed in the 3D rendering window in the Review Tab/Combined 3D/MPR Tab

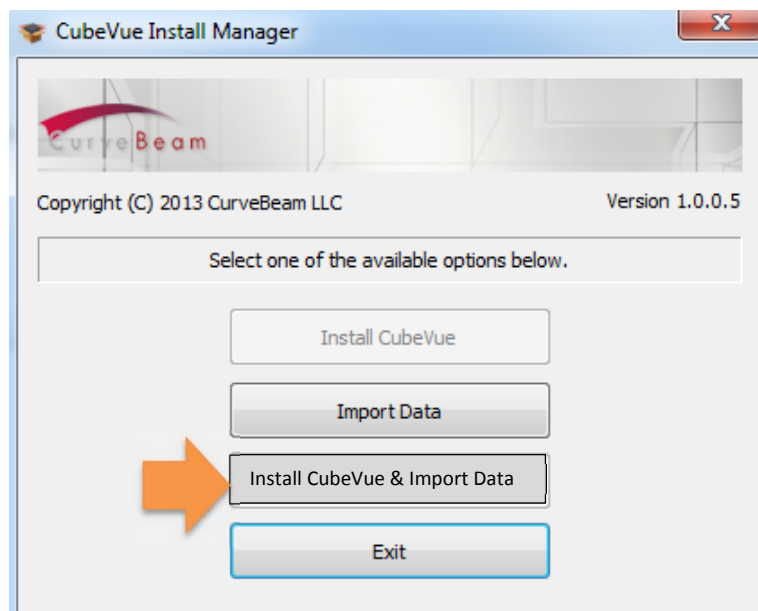

Save As DICOM

The Save As DICOM function is used to save static images in the DICOM format. The purpose of Saving static images, in DICOM format, which is simply an extension of Saving static images in JPEG format. However, the intent of this is more specific to saving images that can be sent to a PACs server or DICOM Application entity, as the JPEG images are not compatible with such systems. This would most commonly be used for saving static 3D rendering images as DICOM files

To Save an Image as DICOM, click on any desired image. The last image window that has been clicked is the Active window. Next, Click **Save as DICOM** in the Output section of the Main Menu Bar.

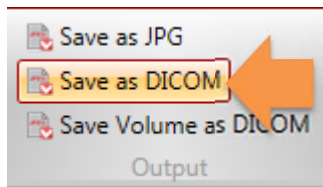

There will be an audio sound when clicked and the image will automatically be saved to the Patient Output folder. There will also be a message in green color at the lower left hand corner of the program that reads "**DICOM IMAGE SAVED**"

Multiple images can be saved in this fashion. These images are then accessible ONLY from the Patient List LOCAL Tab. These images can be loaded and viewed, Exported as DICOM, Media Exported, or also sent to a PACs server or DICOM AE. (see section on DICOM Send for instructions on sending).

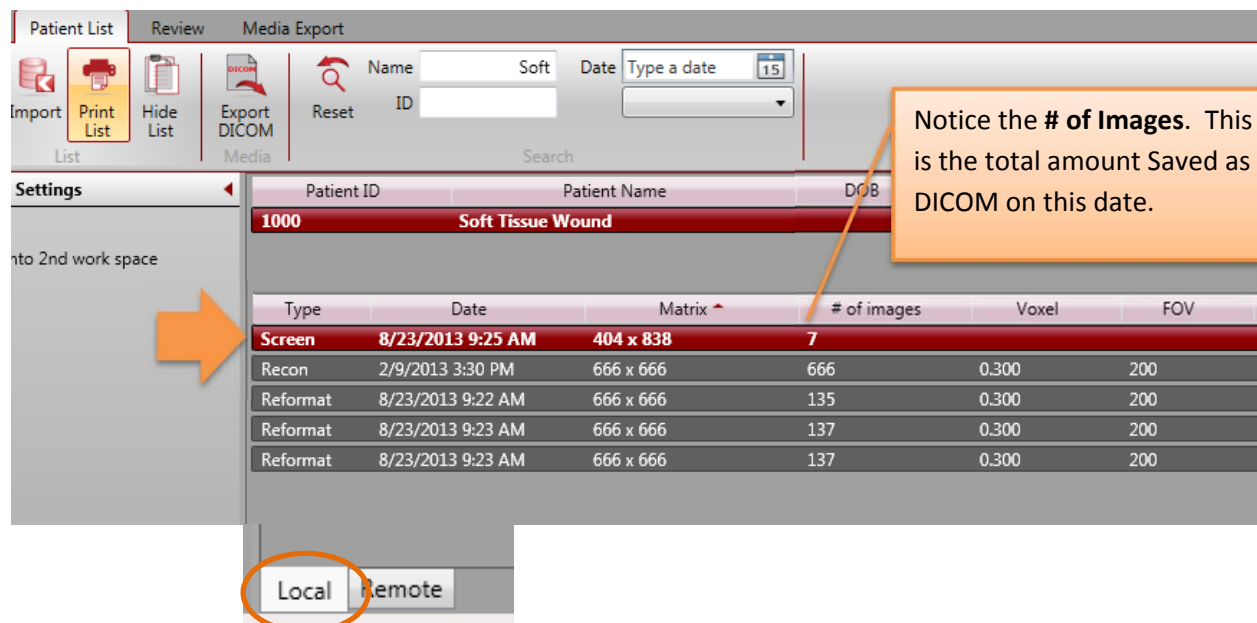

Notice the # of Images. This is the total amount Saved as DICOM on this date.

| Type | Date | Matrix | # of images | Voxel | FOV |
|----------|-------------------|-----------|-------------|-------|-----|
| Screen | 8/23/2013 9:25 AM | 404 x 838 | 7 | | |
| Recon | 2/9/2013 3:30 PM | 666 x 666 | 666 | 0.300 | 200 |
| Reformat | 8/23/2013 9:22 AM | 666 x 666 | 135 | 0.300 | 200 |
| Reformat | 8/23/2013 9:23 AM | 666 x 666 | 137 | 0.300 | 200 |
| Reformat | 8/23/2013 9:23 AM | 666 x 666 | 137 | 0.300 | 200 |

Local Remote

To View the SCREEN images in CubeVue, double click to load. Scroll the mouse wheel to advance to the next image in the Series. This series can also be loaded into the 2nd Workspace.

The functions enabled for SCREEN series are W/L, Zoom, Pan, Zoom to Fit, Reset Pan/Zoom and W/L Settings (reset). To close the SCREEN viewing window, click the “X” on the patient name Tab.

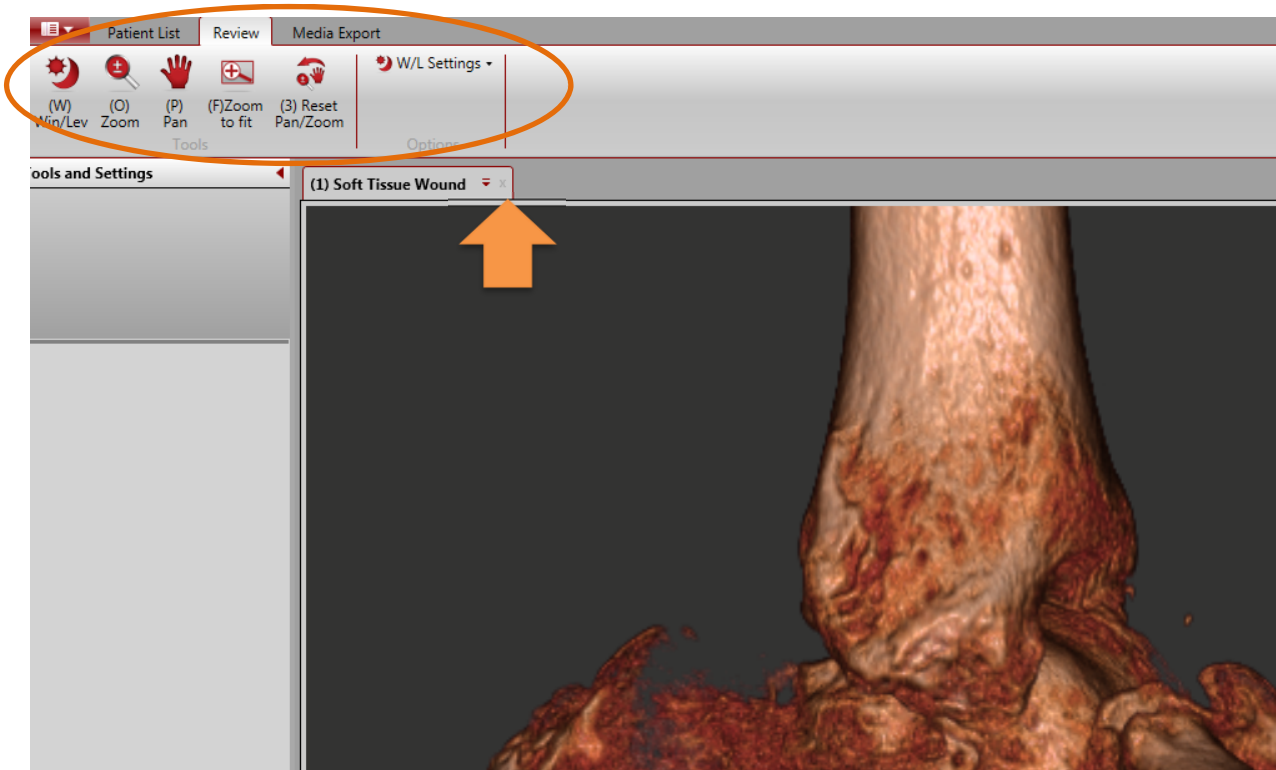

Save Volume as DICOM

The Save Volume as DICOM feature provides a method to re-save your dataset after a re-orientation (volume rotation) in DICOM format. At the same time, it provides functionality to reconstruct the datasets in a format that has a larger slice thickness.

For example, the original datasets are currently reconstructed and saved at 0.3 mm voxel for MFOV scans, and 0.37 mm voxel for LFOV scans. We can utilize this new function if the dataset is desired to be sent to a PACs or DICOM server with a larger slice thickness, such as 1.5 mm. This may be a common need as PACs servers might not easily import the large volume of data at the smaller slice thickness.

This Save Volume as DICOM function also provides a method for reconstructing the volume in axial, coronal and sagittal planes as opposed to the original dataset, which is saved strictly as axial slices. This again may be needed for many PACs/DICOM servers.

Ultimately, from CubeVue we can now re-orient datasets and save the dataset with various slice thicknesses and outputs. We refer to these new saved datasets as “Reformats”. Then we can manually send these reformatted datasets to a PACs/DICOM server as needed. (see section on DICOM Send for instructions on sending).

- To initiate the Save Volume as DICOM feature, first create the orientation that you would like to save or export, then click on the **Save Volume as DICOM** button from the Main Menu Output section from the Review Tab/Combined 3D MPR Tab. This will open the DICOM Volume Creation Window.

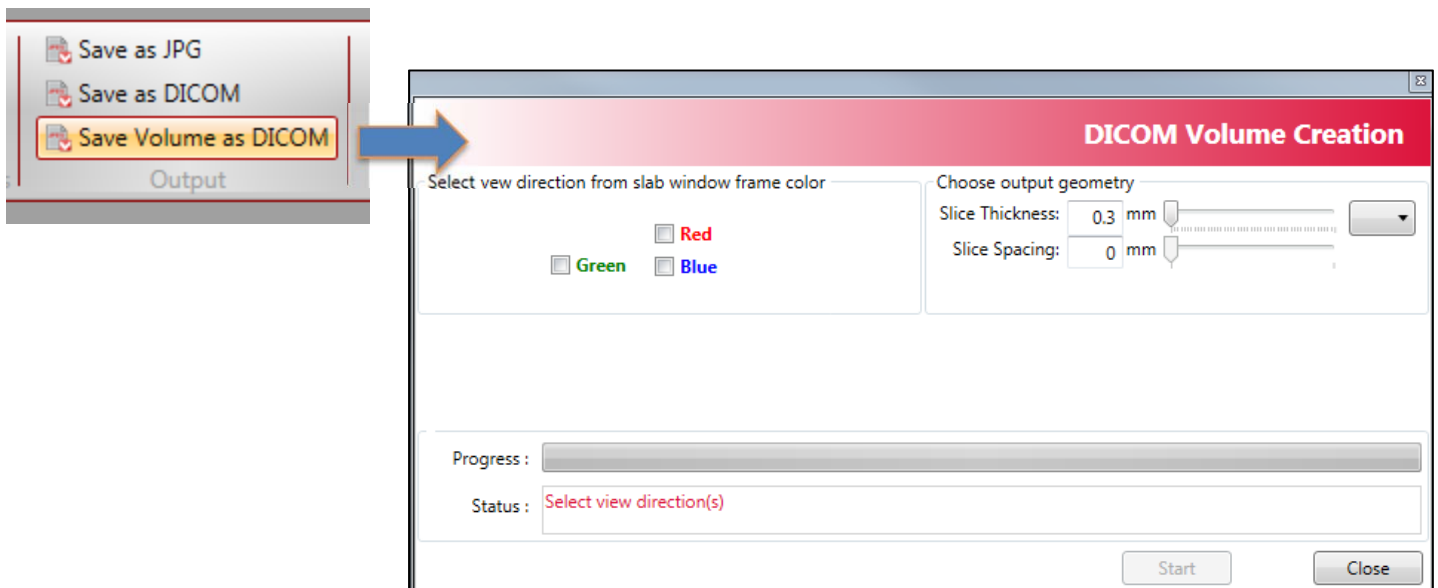

- From this window, first select the desired **View Direction**: In most cases, all of the view directions would be selected. *Red = axial, Green = sagittal, Blue = coronal*. However, there may be an event where only Red (axial) is necessary.

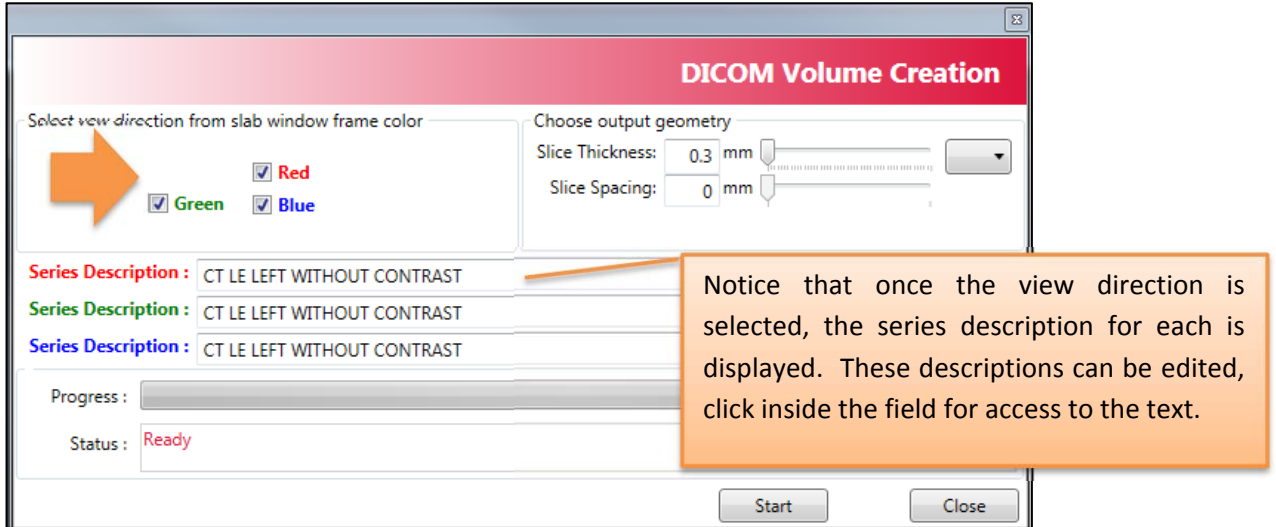

- Next, select the desired **Output Geometry**, then click **Start**. The default for slice thickness will display as either 0.3 mm for a MFOV scan or 0.37 for a LFOV scan. The options are to either click on the drop down menu and select 5x, 10x or 15x. Or you can drag the scroll bar for additional options in the current slice thickness with increments.

5X is recommended in most cases and should be suitable for most needs.

For a MFOV, 0.3 mm voxel scan: 5x = 1.5mm slice thickness

For a LFOV, 0.37 mm voxel scan: 5x = 1.85 mm slice thickness

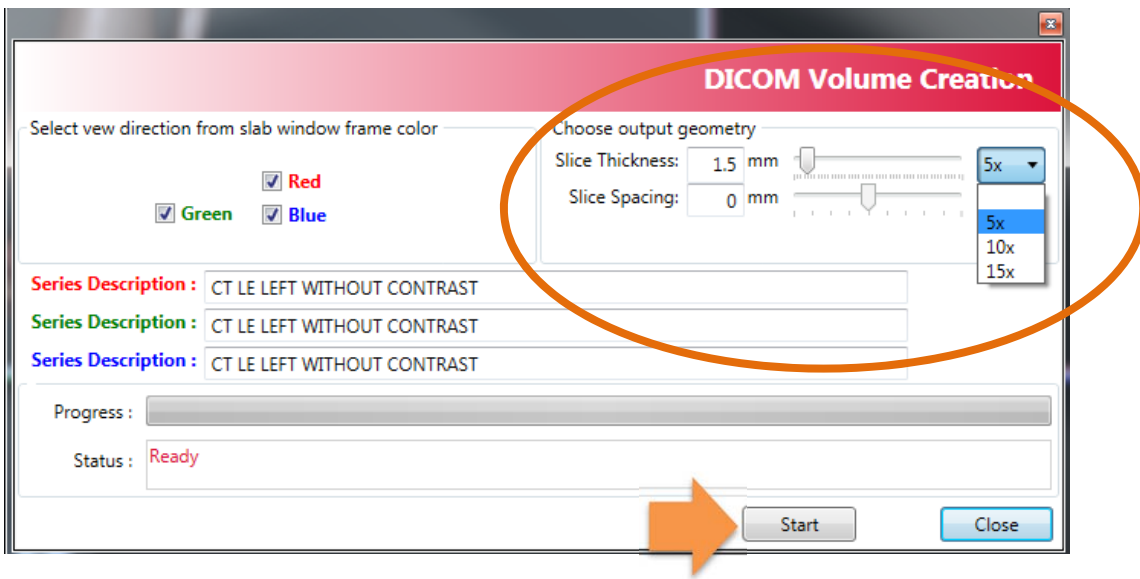

- Once the Status reads **Completed**, click **Close**. **The new Reformatted Datasets will reside under the Patient ID, Series Type in the Patient List LOCAL Tab only. The Series Type will be called **Reformat**.**



If you desire to delete any of these datasets, click on to highlight, right click for the pop up menu, select **Delete** from the menu. Select multiples by holding down the CTRL button then click each desired dataset.

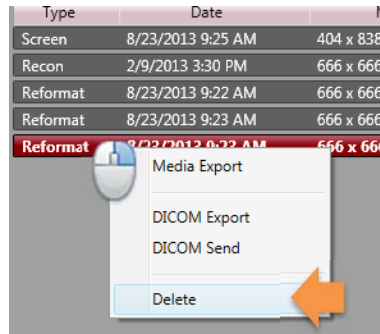

Note: Reformat datasets **Will NOT open** in CubeVue software. These datasets are no longer isotropic and not intended to be viewed in CubeVue. The original Reconstructed (RECON) datasets should be used to view in CubeVue.

DICOM Send

Any of the datasets that reside in the Patient List LOCAL Tab can be sent to a PACs/DICOM server via the DICOM Send functionality. In most cases, the Series Types that will be desired to send via this method would be SCREEN and REFORMAT datasets.

From the Patient List LOCAL Tab, **highlight any or all of the desired Series to send.** Highlight multiples using the traditional method of CTRL click, or highlight all using the traditional method with SHIFT, click on the first and SHIFT click on the last.

- Right click on the highlighted dataset(s) to access the Pop Up menu and select **DICOM Send**.

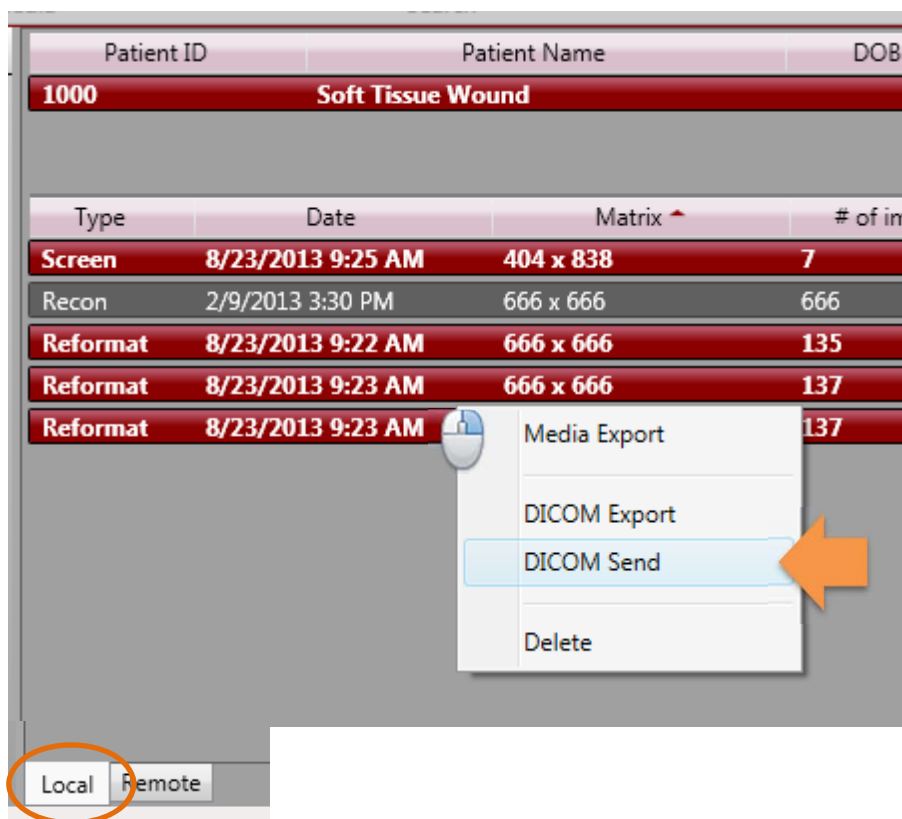

- This will open the *DICOM Sender Window*. In this window, one or multiple **Destinations** for the data send can be configured. Configure a Destination with the appropriate data and click the **Update** button to Save. To add another Destination, click on **New** and edit the Destination items, click Update to Save. Once there are Destination(s) configured, they will remain in the list unless deleted.

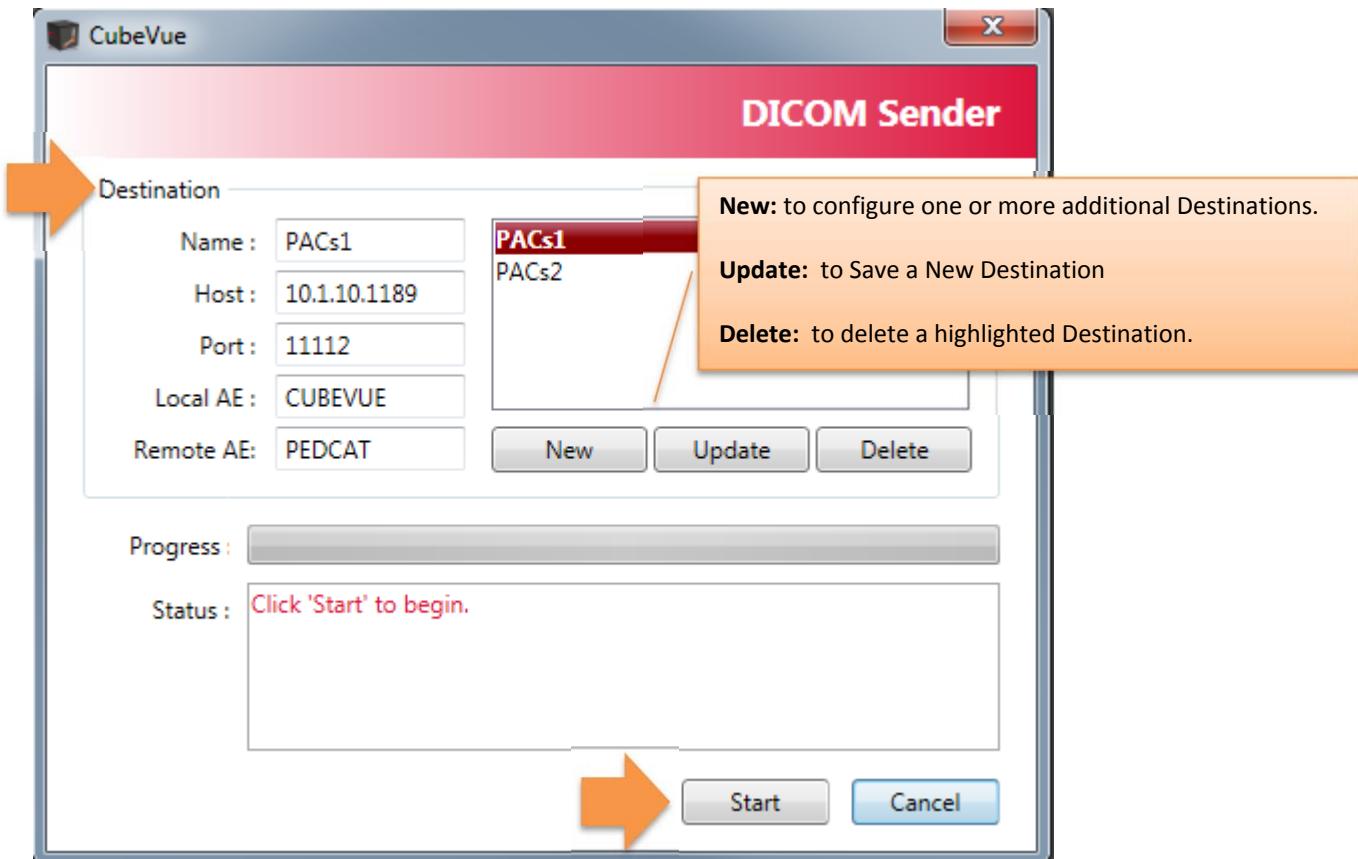

- Click **Start** to begin the Send. The Send time will depend on how many datasets and destinations are selected, the number of reformats created, and the speed of the PACS network.
- When the Send is completed, the Status will read “**Completed**”.

APPENDIX I: PedCAT Installation Instructions

⚠️ WARNING Use of controls or adjustments or performance of procedures other than those specified herein may result in hazardous X-ray radiation or laser light exposure.

The PedCAT Machine will be skidded or crated and shrink wrapped for shipment. The crate should remain upright as instructed on the crate. Please inspect all components and advise CurveBeam of any damage to the crate or items within the crate upon delivery.

The skid will contain:

1. The machine itself.
2. External Server
3. 2 Handle Bars
4. 4 boxes containing 2 thin client terminals, PC, medical grade monitor, control box, cables, phantoms, carbon fiber platform plate, accessories.



1. De-skidding the machine:

The machine first needs to be unbolted from the skid. The shipping mount/bolts are in the front of the machine. Then, the rear cover should be removed before attempting to slide the machine off the crate or else it will be damaged. Once the rear cover is removed, the back of the unit should be slid to the edge of the skid so the 2 rear wheels are hanging off the edge, then lift the unit upright. It will slide down the edge of the skid on to the wheels.

The Unit should be lift gated to ground (onto a dolly if necessary) or by the wheels and rolled into the facility in the upright position:



2. Remove Shipping clamps, ties & screws:

Once the machine is in the area of placement, perform the following:

This Clamp should first be removed:



The underside of the machine has 2 securing cable ties on each side under each door motor which lock down the doors for shipping. And the top of the machine has securing cable ties to help keep the gantry secure. These all must be snipped and carefully removed.



Then the 4 Gantry Clamp Shipping screws can now be removed. These secure the gantry during shipment. They are at the base of the gantry.



3. The back Power Panel has been placed in a “Shipping” position to secure during shipping. This needs to be adjusted to its operational position. Remove the top 2 screws. The remaining 2 mounting screws are stored below the panel.



Shipping position of back Power Panel.
Remove these 2 top screws

The 2 remaining mounting screws are stored here below the panel.

Once the 2 screws are removed, pull the Power Panel out to its operational position and secure into place with the 4 mounting screws.



4. At the location of placement, set the machine down on its base.



- If being placed with the rear to the wall, be sure to leave some room in the back in order to plug in all cables and for securing the rear cover before placing the machine into its final spot.
- There are a total of 4 adjustment “feet” to the machine, one at each corner. There is also a center foot that has no adjustment. The machine should sit on the center foot and lean back onto the 2 back feet. The 2 front feet should not yet be touching the floor at this time. They will be adjusted once the machine leveling is complete.

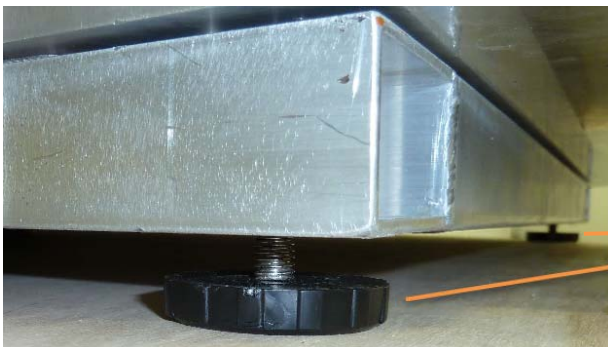

Front leveling feet.

5. Attach all cables and cords to the back of the machine:
 - a. Machine power cord
 - b. Operator's control box
 - c. Door interlock connector
 - d. X-ray warning connector
 - e. 2 CAT 6 ethernet cables that feed to the server. One will be labeled Red for the Red cable and one will be labeled Green for the Green cable.

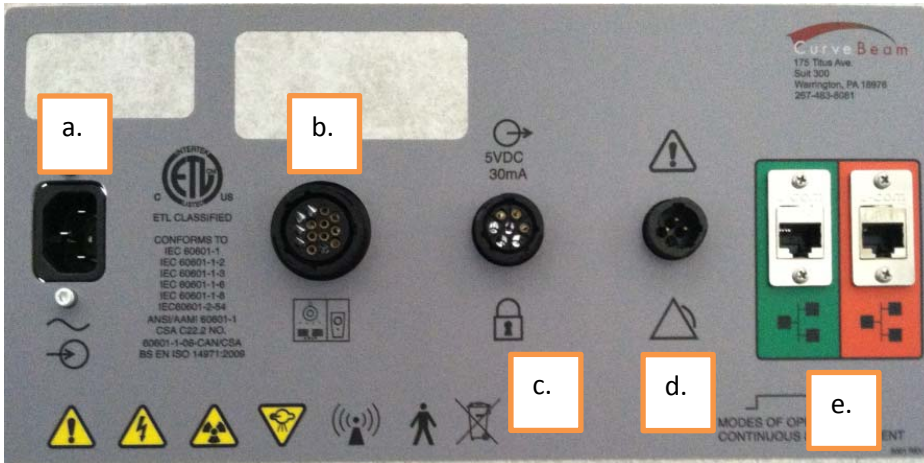

Control Box (b.)



6. Check All connections on boards, circuits etc in the system. Ensure that all are seated.

7. Mount the Varian Receptor Panel:



- a. There are 3 cables to be attached.
 - CAT6 cable (cable tie this cable to the black clip to maintain security).
 - Power cable
 - Ground cable
- b. The Ground nut should be removed from its location, then attach the ground cable and re-attach the Ground nut.



- c. Attach the Panel with 4 Plate screws.
 - The Load position of the panel is in the Gantry “B” position, which is centered.
 - Begin by securing the first 2 screws (vertically) and then manually move the panel to the Gantry Home position, which is rotated to the right, with your hands and secure the other 2 screws (vertically).

- d. Check for Level of the Panel when mounting.
- e. Check for Pivot of the Panel when mounting. The pivot may need to be fine tuned during the panel alignment procedure that will be completed at completion of installation. If the pivot requires adjustment, use the pivot adjustment screws on the panel mount.



- 8. Mount the X-Ray tube head: There is only one twist lock connector and 4 screws for mounting.



9. Mount the Patient Handle Bars:

- There are 2 bars, each is mounted with 2 Screws.
- Each bar has a Ground cable that needs to be attached to the ground screw.



10. Level the Patient Platform:

- Before leveling the platform, be sure to verify that the platform/gantry is stabilized. This can be checked by pulling & pushing the gantry towards & away from the center of rotation, there should be no play. If there is play, you must tighten the screw underneath. The patient platform must be removed to get to this screw.
- The machine should be leveled for left/right and front/back. Place a level on the patient platform area without the plastic platform plate in place.
- Adjust each of the 2 back feet up and/or down to achieve level.
- Once level is achieved, adjust the 2 front feet down to the ground for support.

11. Check Laser Light Alignment:

⚠️ WARNING Use of controls or adjustments or performance of procedures other than those specified herein may result in hazardous laser light exposure.

There are 3 laser lights, one vertical in center of rotation, 2 horizontal at 10cm height and 20 cm height.

Vertical laser light: this should be aligned to the platform center screw as depicted in the below image. If not, adjust it via the adjustment screw on the vertical laser light mechanism to achieve proper location, circled in the below image.



Horizontal Laser Lights: The lower light should be 10 cm above the platform. The upper laser light should be 20 cm above the platform. If not, adjust each adjustment screw on the horizontal laser light mechanisms to achieve proper location.

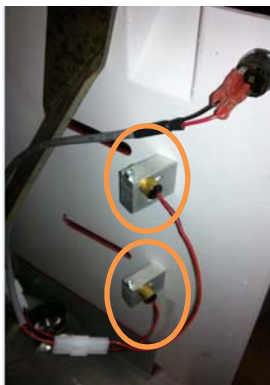

12. Server Setup:

The External server consists of 4 Virtual Machines, on the right hand side. It is contained in a case that also has a UPS unit, on the left hand side. The first step will be to plug in the UPS Battery Plug, located beneath the UPS cover.

UPS unit

Server



Remove the left cover from the bottom clip. Connect the battery plug. Turn the UPS ON with the button below the plug and verify that it is powered. Replace the cover.



Plug in all cords in the back of the case:

- 2 CAT6 Ethernet cables (Red & Green)
- 2 cables from Server to each of the 2 Thin Client Terminals.
- 2 power plugs from the server to the UPS unit.
- 1 Power cord.
- HUB (switch for the thin client terminals)



Turn ON the server and verify that all VM's are powered ON. You must remove the right hand side cover to access the ON button to the server.

Connect the ACQ Thin Client Terminal to the HUB, and connect the HUB cable to the server. Plug in the Thin Client Terminal box, Monitor and mouse. Turn the Thin Client Terminal box ON.

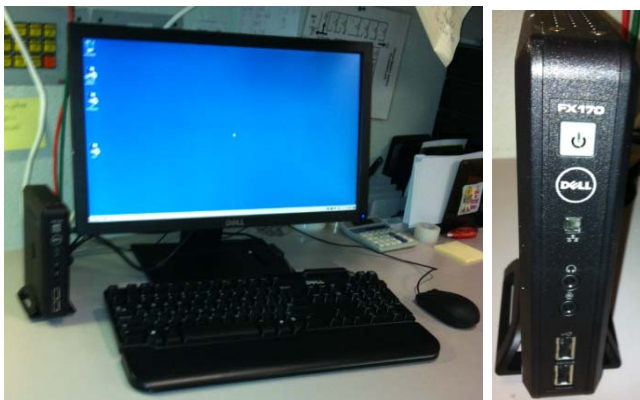

Connect the Viewing Station/MD Thin Client Terminal to the server. Plug in the Thin Client Terminal box, Monitor and mouse. Turn the Thin Client Terminal box ON.

13. Turn the Power to the machine ON from the Main Circuit Breaker at the back of the machine. This is the only ON button for the machine. ON position = I, OFF position = 0.



14. Once all connections are secure and the machine is Powered ON, launch the ACQ Connection from the icon on the Main Connection Desktop of the ACQ Thin Client Terminal.
15. Once connected to the ACQ Desktop, launch the PedCAT ACQ “CB Scanning Device” software from the icon. Verify StartUp/Initialization has completed. Each of the on-screen lights should light up. During the startup/initialization observe the machine for any vibration, unexpected performance or deterioration of performance.

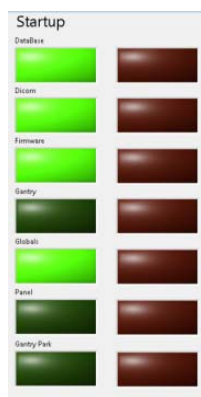

The StartUp sequence is designed to run diagnostics to ensure that all components of the systems are functioning as expected. There are checks for communication to the data storage (DICOM VM), communication with the firmware, and operation and homing of all motors which include the gantry motor, panel motor, beam limiter motor and both door motors. If there is a failure in any of these, the software will not advance to the scan Acquisition section.

16. If all initializes properly, attach the rear cover with the 4 button screws and push the machine to its final position. If there is a StartUp issue, please re-check all connections, re-boot the machine and attempt again. If an issue continues, please contact CurveBeam Technical Support.
17. Follow ALL the Alignment, Calibration QA procedures outlined in **Chapter 4** of this manual. INSTALLATION is NOT COMPLETE until all these procedures are successfully completed.

APPENDIX II: Troubleshooting

Error Messages:

System failures that may result in a scan failure will be accompanied by Error Messages in the software. The user should follow the instructions to resolve the error, however if the Warning message persists, the user should contact CurveBeam technical support at 267-483-8081. If the system fails to operate in any other way or if your problem is not listed, please contact CurveBeam technical support at 267-483-8081.

Firmware Monitoring Warning: Upon startup of the “CB Scanning Device” Acquisition software, the system checks that the embedded controller firmware software version is the correct version to operate with unit. If an unsupported version number firmware software resides on the embedded controller then the following error message will display and the Acquisition software will terminate. In the event of this error message, please contact CurveBeam technical support.

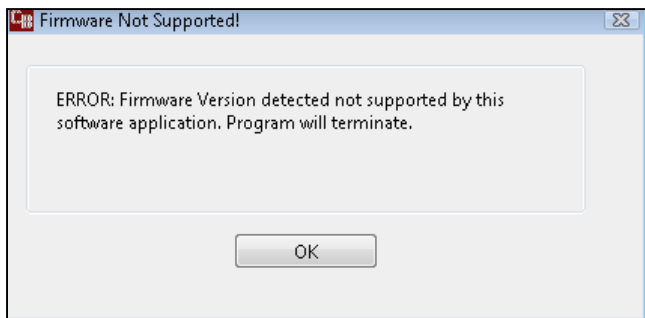

Temperature Monitoring Warnings: The system is designed to send a Warning message to the user if the internal temperature of the machine is below 35° C or above 45° C. This Warning would display in the “CB Scanning Device” Acquisition software at Startup and just before a scan is captured. If the temperature is below the 35° C limit then the resulting image quality may not be optimal, however the system will permit scanning (for either upper or lower temperature conditions).

The Warning message reads:

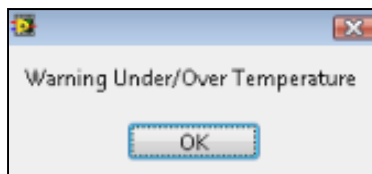

Startup: Note that there is an Internal Temperature gage in the Startup Screen. If in the Startup Screen and the temperature monitor has detected temperature out of range, the warning message will display during the Startup sequence.

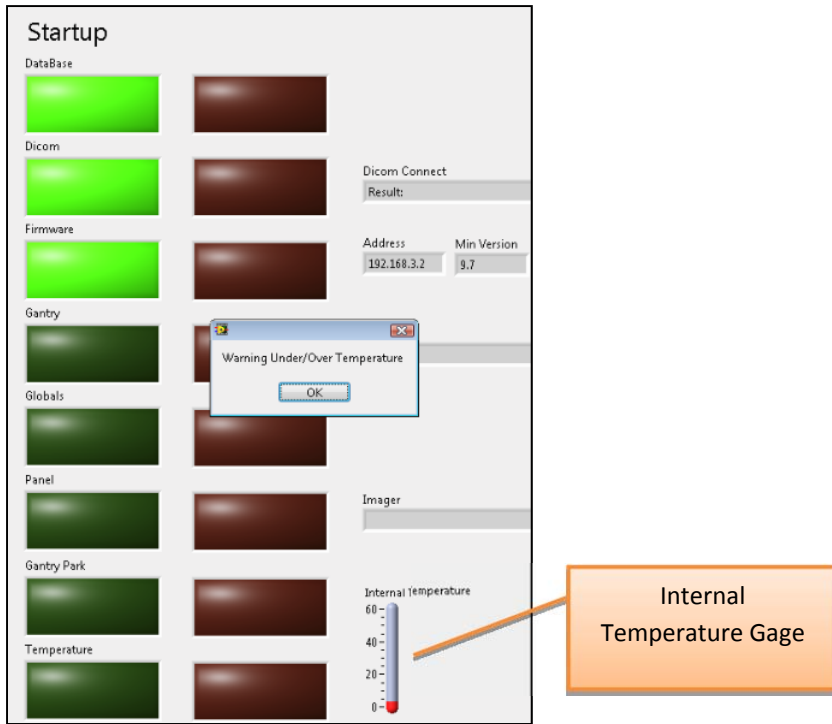

Scan: If in the Procedure Tab and the temperature monitor has detected temperature out of range, the warning message will display once the OK button is clicked.

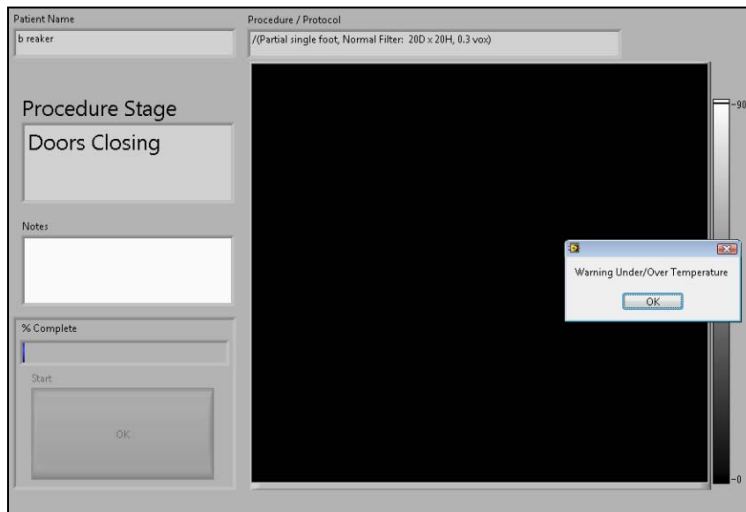

Temperature Monitoring Failures: The system is designed to send a Failure message to the user if the internal temperature of the machine is 20° C or lower OR 60° C or higher. This Failure message would display in the “CB Scanning Device” Acquisition software at Startup and just before a scan is captured. If this condition occurs the error message will force the acquisition program to terminate and disallow any scanning.

In the event of such Failure message, the user should re-start the system via the Circuit Breaker ON/OFF switch and then re-launch the “CB Scanning Device” Acquisition software. If the message still displays, the user should contact CurveBeam technical support.

The Failure Message reads:

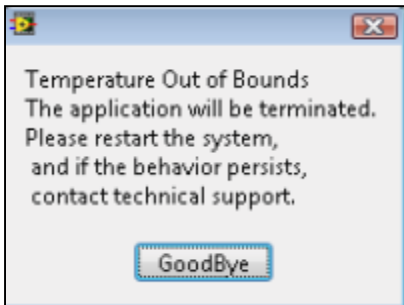

Startup: Note that there is an Internal Temperature gage in the Startup Screen. If in the Startup Screen and the temperature monitor has detected temperature out of range, the failure message will display during the Startup sequence.

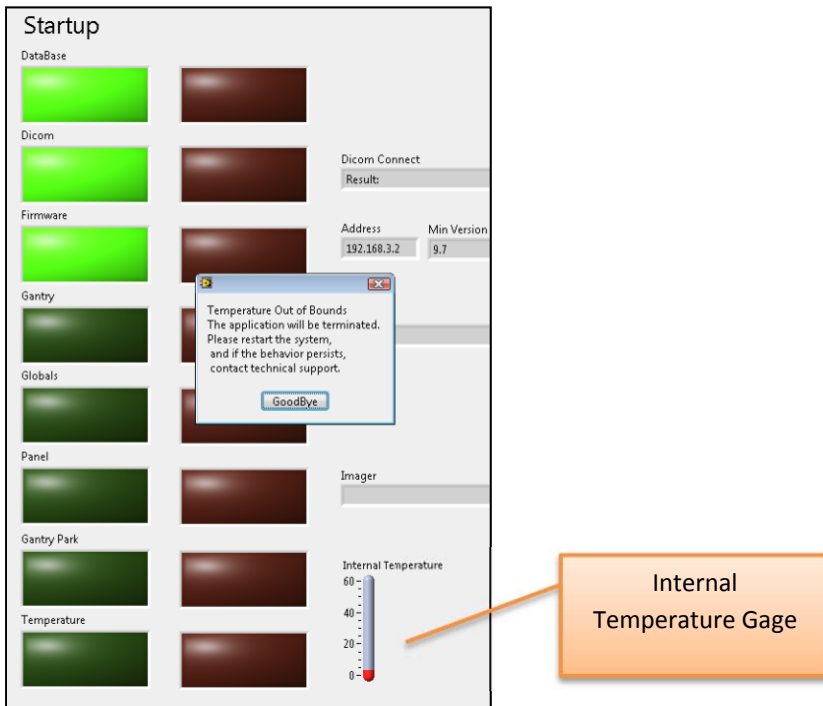

Scan: If in the Procedure Tab and the temperature monitor has detected temperature out of range, the failure message will display once the OK button is clicked.

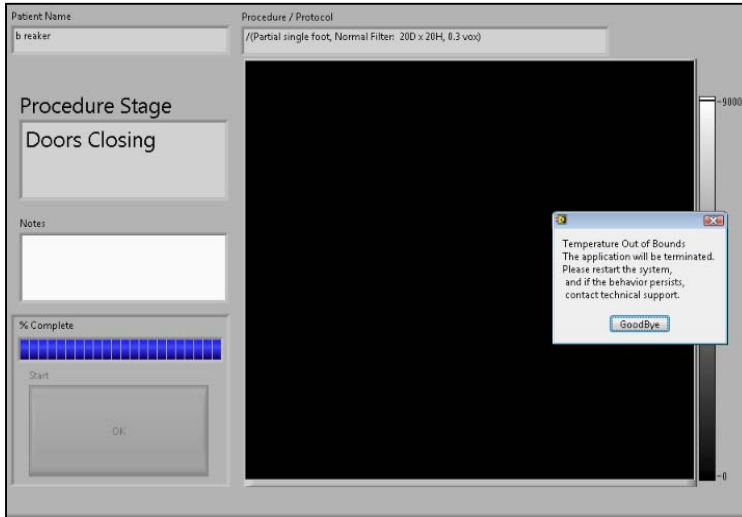

Beam Collimator Mechanism Failure: The beam collimator is a motorized mechanism which select position dependent on the scan procedure selected. An error message will display if there are any issues with the motor, such as a stall or jam, or switches that control the movement of the beam collimator mechanism. This message can display at Startup screen or in the Procedure Tab as the system sets up for the scan.

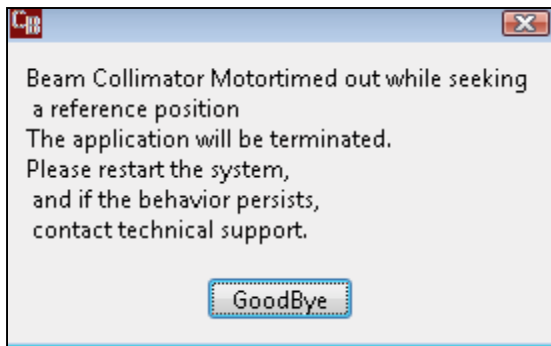

Panel Position Mechanism Failure: The Panel Position Mechanism is a motorized mechanism which selects its position dependent on the scan procedure selected. An error message will display if there are any issues with the motor, such as a stall or jam, or switches that control the movement of the Panel Position mechanism. This message can display at Startup screen or in the Procedure Tab as the system sets up for the scan.

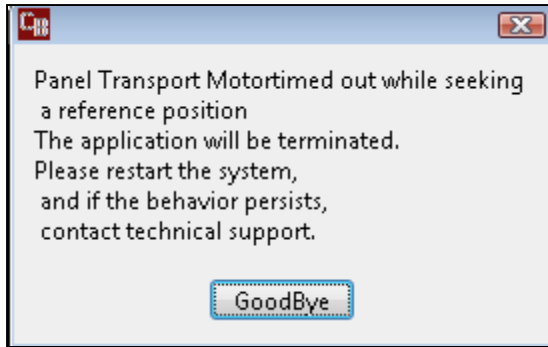

Gantry Rotation Position Mechanism Failure: The Gantry Rotation Mechanism is a motorized mechanism as well. An error message will display if there are any issues with the motor, such as a stall or jam that would result in the Gantry not finding its proper positioning. This message can display at Startup screen or in the Procedure Tab as the system sets up for the scan.

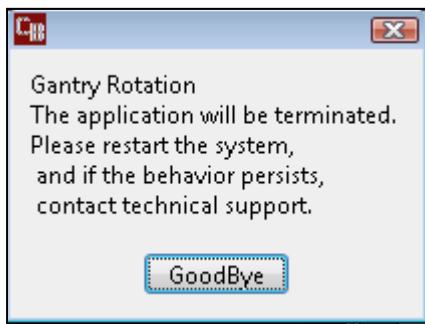

An error in Gantry Rotation *during a scan* would result in a communication error of the receptor panel to the server, so if this even occurs, the following Panel Readout error message would display:



Gate Drive Mechanism Failure: The Gate Drive Mechanism is a motorized mechanism which opens and closes each door at the appropriate times. An error message will display if there are any issues with the motors, such as a stall or jam, or switches that control the movement of the

Gate mechanism. This message can display at Startup screen or in the Procedure Tab as the system sets up for the scan.

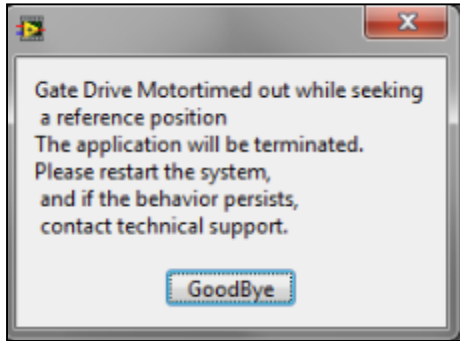

Panel Read Out Error Message: If any communication failure occurs before or during a scan between the receptor panel and the server, then a Panel Readout Error will display on Screen. Communication errors could occur if the cable is not plugged in or seated correctly or has suffered some damage, or if the panel does not properly produce frames. The “CB Scanning Device” Acquisition software will terminate. Check cables and Restart the system.



Communication Error between the Firmware and the Server: If there is any loss of communication between the embedded controller firmware, the following error message will display on screen. Loss of communication can be caused by a damaged, unplugged or loose embedded controller cable, or when the Emergency Stop button has been pressed. The “CB Scanning Device” Acquisition software will terminate. Check cables and E-stop and restart the system.



Exposure Timeout Error Message: In the event of a system fault that may result in the X-ray exposure not terminating at its appropriate time, there is a backup timer to terminate the exposure. If this occurs, the below error message will display on screen. Click OK and restart the system. If the error occurs again, contact CurveBeam Technical Support.

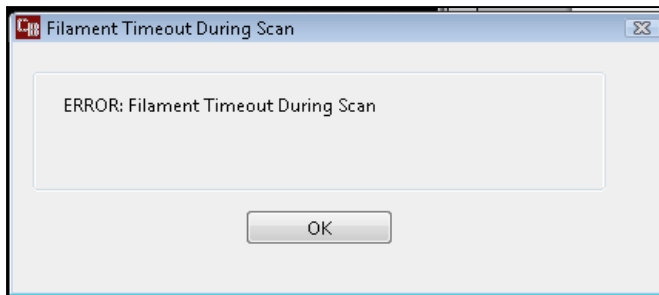

Scan Button Released Error Message: If the operator releases the scan button BEFORE completion of an exposure, the X-ray will turn off and the below error message will display notifying the user of the error.

If this occurs, the operator should review the reconstructed data to determine if the data capture was sufficient for diagnosis. If not, a new scan may be necessary.

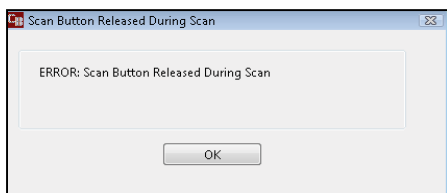

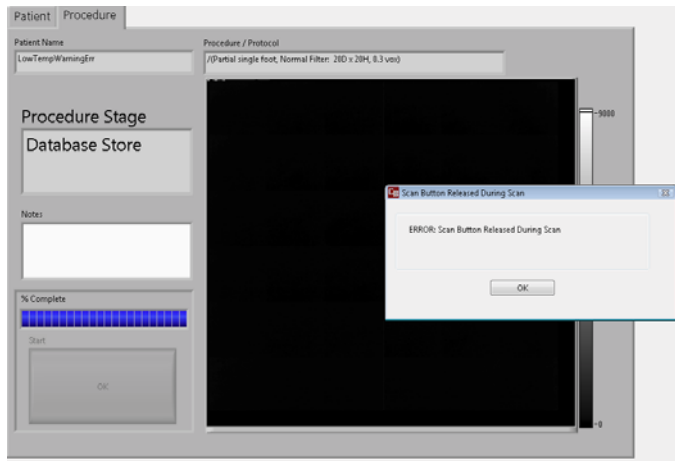

Calibration Checks and Services Warnings: The system calls for monthly Panel Calibrations and checks of certain control functions as outlined in this manual. A monthly Warning message will appear that will indicate that it is time for these checks.

The Warning message reads:

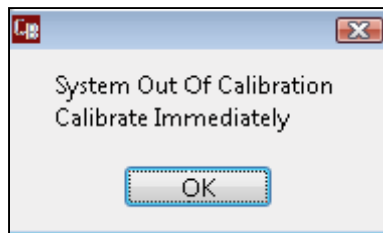

Startup: When the monthly calibration and checks are due, the message will display during the Startup sequence. The user should click OK and then should contact CurveBeam technical support who will assist in the calibration and checks via remote access. This message will repeat at Startup until the procedures are completed. Once the procedures are completed the warning message will be reset by CurveBeam technical support.

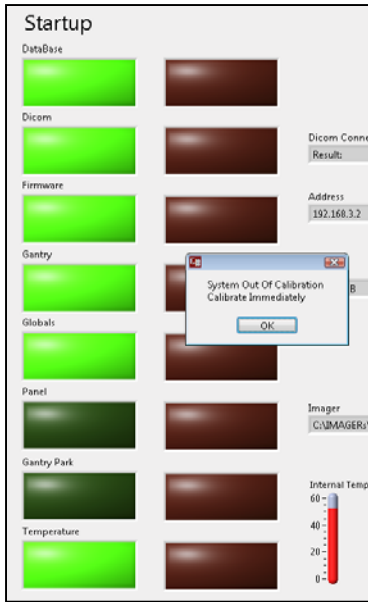

Scan: When the monthly calibration and checks are due, the message will display in the Procedure Tab when the OK button is clicked. When the message displays, the user should click OK and then should contact CurveBeam technical support who will assist in the calibration and checks via remote access. This message will repeat at Scan time until the procedures are completed. Once the procedures are completed the warning message will be reset by CurveBeam technical support.

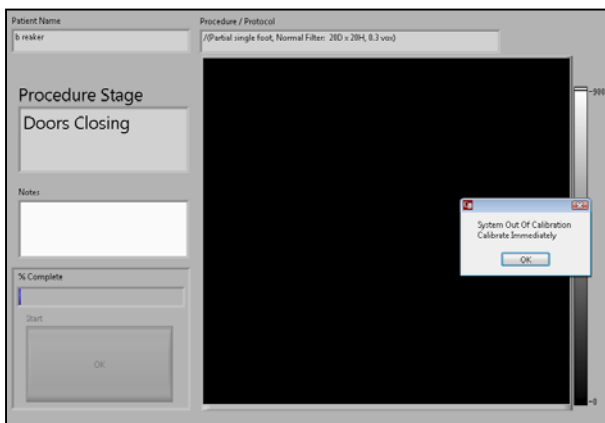

QA Service and Maintenance Warnings: The system calls for annual QA procedures and system maintenance as outlined in this manual. An annual Warning message will appear that will indicate that it is time for these services.

The Warning message reads:

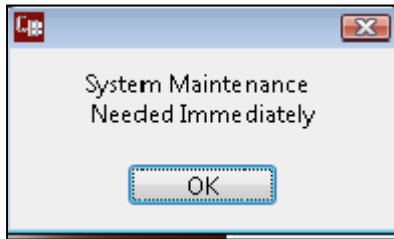

Startup: When the annual service is due, the message will display during the Startup sequence. The user should click OK and then should contact CurveBeam technical support who will schedule the service and maintenance. This message will repeat at Startup until the procedures are completed. Once the procedures are completed the warning message will be reset by CurveBeam technical support.

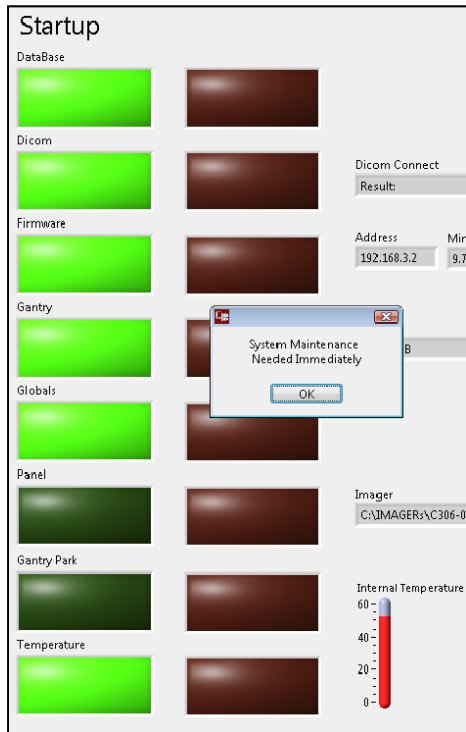

Scan: When the annual service is due, the message will display in the Procedure Tab when the OK button is clicked. When the message displays, the user should click OK and then should contact CurveBeam technical support who will schedule the service and maintenance. This message will repeat at Scan time until the procedures are completed. Once the procedures are completed the warning message will be reset by CurveBeam technical support.

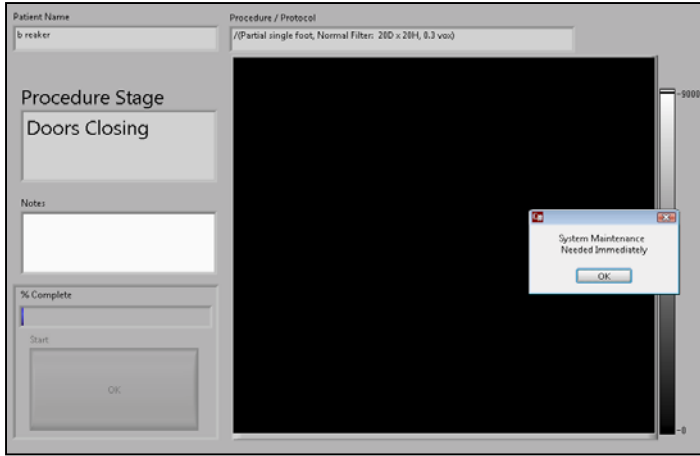

APPENDIX III: Scan Protocol Technical Details:

| | |
|---|---|
| pedCAT Study Type: | Foot and Ankle Cone Beam CT |
| Scan Positions/Orientations: | Weight Bearing (standing), Seated (partial or non weight bearing) |
| CT Scanner make and model: | CurveBeam pedCAT |
| Maximum # of Slices per acquisition: | N/A: System is Volume Cone Beam CT |

pedCAT has 5 Scan Protocol options:

| Acquisition series (include all) (i.e., axial, helical) | Medium Field 100 kVp (small patient) | Medium Field 120 kVp | Large Field 100 kVp (small patient) | Large Field 120 kVp | Medium Field Sharp, 120 kVp |
|---|---|---|---|---|---|
| kVp/mA and rotation time or kVp/mAs | kVp = 100 mA = 5 mAs = 22.62 Rotation time = 16 seconds | kVp = 120 mA = 5 mAs = 22.62 Rotation time = 16 seconds | kVp = 100 mA = 5 mAs = 45.24 Rotation time = 32 seconds | kVp = 120 mA = 5 mAs = 45.24 Rotation time = 32 seconds | kVp = 120 mA = 5 mAs = 22.62 Rotation time = 16 seconds |
| CTDI (vol) required (if on system) | 0.47 mGy | 0.89 mGy | 0.63 mGy | 1.10 mGy | 0.89 mGy |
| Dose length product (DLP) required if on system | - | - | - | - | - |
| Total dose per acquisition and/or total dose per study if available in units given | Dose Area Product = 492 mGy*cm ² | Dose Area Product = 803 mGy*cm ² | Dose Area Product = 897 mGy*cm ² | Dose Area Product = 1484 mGy*cm ² | Dose Area Product = 803 mGy*cm ² |
| Tube current modulation or dose reduction technique (is used) | 12 millisecond pulsed. 377 pulses/scan | 12 millisecond pulsed. 377 pulses/scan | 12 millisecond pulsed. 754 pulses/scan | 12 millisecond pulsed. 754 pulses/scan | 12 millisecond pulsed. 377 pulses/scan |

| | | | | | |
|---|---|---|---|---|---|
| Anatomical Scan range (i.e., dome of liver thru pubic symphysis) | L or R Ankle and midfoot <i>or</i> L or R midfoot & forefoot | L or R Ankle and midfoot <i>or</i> L or R midfoot & forefoot | L or R Ankle and entire foot <i>or</i> bilateral feet and ankles | L or R Ankle and entire foot <i>or</i> bilateral feet and ankles | L or R Ankle and midfoot <i>or</i> L or R midfoot & forefoot |
| Increment (space between slices) | 0 mm | 0 mm | 0 mm | 0 mm | 0 mm |
| Detector collimation (mm) | Fixed 7-8% of detector, factory calibrated | Fixed 7-8% of detector, factory calibrated | Fixed 7-8% of detector, factory calibrated | Fixed 7-8% of detector, factory calibrated | Fixed 7-8% of detector, factory calibrated |
| Slice thickness (mm) | 0.3 mm | 0.3 mm | 0.37 mm | 0.37 mm | 0.3 mm |
| Pitch or table feed | 0 | 0 | 0 | 0 | 0 |
| Scan FOV (cm) | 20 cm diameter x 20 cm height | 20 cm diameter x 20 cm height | 35 cm diameter x 20 cm height | 35 cm diameter x 20 cm height | 20 cm diameter x 20 cm height |
| Kernel/filter | - | - | - | - | Sharp |
| Reformat technique (i.e., 3D, plane/views) | Automatic (coronal/sagittal volumes optional) | Automatic (coronal/sagittal volumes optional) | Automatic (coronal/sagittal volumes optional) | Automatic (coronal/sagittal volumes optional) | Automatic (coronal/sagittal volumes optional) |
| Contrast type/rate (if applicable) | Not Used | Not Used | Not Used | Not Used | Not Used |
| Time from contrast injection to image acquisition, if applicable (sec) | Not Used | Not Used | Not Used | Not Used | Not Used |